

T32MZ

DIGITAL PROPORTIONAL
RADIO CONTROL SYSTEM



INSTRUCTION MANUAL

Futaba[®]

Digital Proportional R/C System

TABLE OF CONTENTS

INTRODUCTION 4

- Support and Service 4
- Application, Export, and Modification..... 5
- Definitions of Symbols..... 6
- Safety Precautions (do not operate without reading) 6

BEFORE USE 10

- Features..... 10
- Contents and Technical Specifications..... 12
- Transmitter controls 13
 - Cautions on handling antenna 13
 - LED monitor 14
 - Toggle switch (SA-SH)..... 15
 - Volume (LD, RD) 16
 - Back side switch (SI, SJ) 16
 - Slide Lever (LST, LS, RS, RST)..... 16
 - Digital trim (T1-T6) 17
 - Touch panel 17
- HOME/EXIT & U.MENU/MON. Button 18
- Stick Adjustment..... 19
- Battery exchange 22
- Battery charging 24
- microSD card 25
- Back side connector 26
- Receiver R7108SB nomenclature 27
 - Connector 27
 - Link / Mode Switch..... 27
 - Extra Voltage Connector 27
 - Connection of a receiver battery 28
 - Connection example..... 28
 - R7108SB CH Mode..... 29
- Servo(Optional) / Toolbox / Receiver switch 30
- Receiver's Antenna Installation 31
- Safety precautions when installing receiver and servos..... 32
- S.BUS Installation 33
- S.BUS2 System..... 34
- S.BUS device setting..... 35
- Telemetry System..... 36

BASIC OPERATION 37

- How to turn ON/OFF the transmitter 37
- Home screen 38

- Sub-Display..... 39
- Link procedure (T32MZ ⇔ R7108SB) 40
- How to change the number of value 41
- How to activate the function..... 41
- How to return to home screen or go back.. 41
- Page of each setting screen 41
- Switch selection 42
- Display of operation status 42
- Home 2 screen 43
- Panel lock..... 43
- Registration of the user's name 44

MODEL BASIC SETTING PROCEDURE.. 45

- Airplane/glider basic setting procedure..... 45
- Helicopter basic setting procedure..... 47
- Servos connection by model type 51

FUNCTIONS OF SYSTEM MENU 56

- Trainer 57
- Display 60
- Date and Time..... 61
- User Name 62
- Switch 63
- H/W Setting 64
- Sound Volume 66
- Player 67
- S.BUS Servo 68
- Information 71
- Unit System 72
- Range Check 73

FUNCTIONS OF LINKAGE MENU 74

- Servo Monitor..... 75
- Model Select..... 76
- Model Type..... 77
- Picture 79
- Sound 80
- System Type..... 82
 - System Type selection 82
- Receiver linking 82
- Dual receiver function 82
- Telemetry function 82

D/L Interval	82	AIL to Camber FLP	137
Battery fail-safe voltage setup	82	AIL to Brake FLP	138
Linking method (T32MZ ↔ R7108SB)	83	AIL to RUD	139
The example for choosing System Type	84	Airbrake to ELE.....	140
Function	85	RUD to AIL.....	141
Sub-Trim	87	Camber Mix.....	142
Servo Reverse	88	ELE to Camber.....	144
Fail Safe	89	Camber FLP to ELE	145
End Point (ATV).....	90	Butterfly.....	146
Throttle Cut (Airplane/helicopter only).....	91	Trim Mix 1/2	148
Idle Down (Airplane/helicopter only)	92	Airbrake	150
Swash Ring (Helicopter only)	93	Gyro (Airplane)	152
Swash (Helicopter only)	94	V-tail.....	153
Timer	96	Ailevator	154
Dial Monitor	98	Winglet	155
Function Name	99	Motor	156
Telemetry.....	100	RUD to ELE.....	157
Audible telemetry information	101	Snap Roll.....	158
Receiver Battery Display	102	Multi Engine	159
Temperature Display	103	Acceleration	160
RPM Display	103	● Helicopter Functions.....	161
Altitude Display	104	PIT Curve.....	162
GPS Display	106	THR Curve.....	165
Voltage Display.....	108	Acceleration	167
Current / Voltage / Capacity Display.....	109	Throttle Hold.....	168
Servo sensor Display.....	110	Swash Mix.....	169
Airspeed Display	111	Throttle Mix	170
Sensor	112	PIT to Needle	171
Sensor Name.....	117	PIT to RUD.....	172
Telemetry Setting.....	118	Gyro.....	173
Warning	120	Governor.....	174
Data Reset	121	Throttle Limiter	175
User Menu.....	122		
Condition Hold (Helicopter only).....	123		
<hr/>			
FUNCTIONS OF MODEL MENU	124	COMMON OPERATIONS USED IN	FUNCTION SETUP SCREEN
Servo Monitor (Linkage Menu ..75)			176
Condition Select	125	Flight conditions	176
AFR (D/R).....	127	Fine tuning VR setting	176
Prog. Mixes (Program mixing).....	129	Servo speed.....	177
Fuel Mixture.....	132	Curve setting	178
● Airplane/Glider Functions.....	133	Switch selection.....	182
AIL Differential.....	135		
Flap Setting.....	136		
<hr/>			
		UPDATING	186
<hr/>			
		T18MZ → T32MZ MODEL DATA	
		CONVERSION.....	187

INTRODUCTION

Thank you for purchasing a Futaba 32MZ digital proportional R/C system. This system is extremely versatile and may be used by beginners and pros alike. In order for you to make the best use of your system and to fly safely, please read this manual carefully. If you have any difficulties while using your system, please consult the manual, our online Frequently Asked Questions (on the web pages referenced below), your hobby dealer.

Due to unforeseen changes in production procedures, the information contained in this manual is subject to change without notice.

<http://www.futabausa.com>

(<http://www.rc.futaba.co.jp/english>)

Application, Export, and Modification

1. This product is only designed for use with radio control models. Use of the product described in this instruction manual is limited to radio control models.
2. Exportation precautions:
 - (a) When this product is exported, it cannot be used where prohibited by the laws governing radio waves of the destination country.
 - (b) Use of this product with other than models may be restricted by Export and Trade Control Regulations.
3. Modification, adjustment, and replacement of parts: Futaba is not responsible for unauthorized modification, adjustment, or replacement of parts on this product.

Outside North America

Please contact the Futaba importer in your region of the world to assist you with any questions, problems or service needs. Please recognize that all information in this manual, and all support availability, is based upon the systems sold in North America only. Products purchased elsewhere may vary. Always contact your region's support center for assistance.

Compliance Information Statement (for U.S.A.)

This device complies with part 15 of the FCC Rules. Operation is subject to the following two conditions:

- (1) This device may not cause harmful interference, and (2) This device must accept any interference received, including interference that may cause undesired operation.
- (3) RF Radiation Exposure Statement (For T32MZ)

This equipment complies with FCC radiation exposure limits set forth for an uncontrolled environment. This transmitter must not be co-located or operating in conjunction with any other antenna or transmitter.

RF Radiation Exposure Statement (For R7108SB)

This equipment complies with FCC radiation exposure limits set forth for an uncontrolled environment. This equipment should be installed and operated with minimum distance 20 cm between the radiator & your body.

The responsible party for the compliance of this device is:

Futaba Service Center

2681 Wall Triana Hwy Huntsville, AL 35824, U.S.A.

TEL 1-256-461-9399 or E-mail: contactus@futaba.com

CAUTION:

To assure continued FCC compliance:

Any changes or modifications not expressly approved by the grantee of this device could void the user's authority to operate the equipment.

Compliance Information Statement (for Canada)

This device complies with Industry Canada license-exempt RSS standard (s). Operation is subject to the following two conditions: (1) this device may not cause interference, and (2) this device must accept any interference, including interference that may cause undesired operation of the device. This equipment complies with IC radiation exposure limits set forth for an uncontrolled environment. This transmitter must not be co-located or operating in conjunction with any other antenna or transmitter.

French: Cet appareil radio est conforme au CNR-247 d'Industrie Canada. L'utilisation de ce dispositif est autorisée seulement aux deux conditions suivantes : (1) il ne doit pas produire de brouillage, et (2) l'utilisateur du dispositif doit être prêt à accepter tout brouillage radioélectrique reçu, même si ce brouillage est susceptible de compromettre le fonctionnement du dispositif. Cet équipement est conforme aux limites d'exposition aux rayonnements IC établies pour un environnement non contrôlé.

Cet équipement est conforme aux limites d'exposition aux rayonnements IC établies pour un environnement non contrôlé. Cet émetteur ne doit pas être co-situé ou fonctionner conjointement avec une autre antenne ou émetteur.

Declaration of Conformity (for EU)

Hereby, Futaba Corporation declares that the radio equipment type is in compliance with Directive 2014/53/EU.

The full text of the EU declaration of conformity is available at the following internet address:

<http://www.rc.futaba.co.jp/english/dl/declarations.html>

Where to Fly

We recommend that you fly at a recognized model airplane flying field. You can find model clubs and fields by asking your nearest hobby dealer, or in the US by contacting the Academy of Model Aeronautics.

You can also contact the national Academy of Model Aeronautics (AMA), which has more than 2,500 chartered clubs across the country. Through any one of them, instructor training programs and insured newcomer training are available. Contact the AMA at the address or toll-free phone number below.

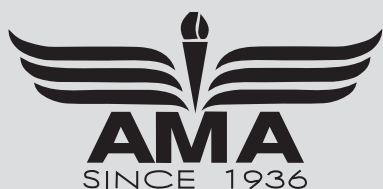

Academy of Model Aeronautics

5161 East Memorial Drive

Muncie, IN 47302

Tele. (800) 435-9262

Fax (765) 289-4248

or via the Internet at <http://www.modelaircraft.org>

❗ **Always pay particular attention to the flying field's rules**, as well as the presence and location of spectators, the wind direction, and any obstacles on the field. Be very careful flying in areas near power lines, tall buildings, or communication facilities as there may be radio interference in their vicinity.

Precautions

Application, Export, and Modification Precautions.

1. This product is only designed for use with radio control models. Use of the product described in this instruction manual is limited to radio control models.
2. Export precautions:
 - a) When this product is exported, it cannot be used where prohibited by the laws governing radio waves of the destination country.
 - b) Use of this product with other than models may be restricted by Export and Trade Control Regulations.
3. Modification, adjustment, and parts replacement:

Futaba is not responsible for unauthorized modification, adjustment, or replacement of parts on this product.

 - No part of this manual may be reproduced in any form without prior permission.
 - The contents of this manual are subject to change without prior notice.
 - The contents of this manual should be complete, but if there are any unclear or missing parts please contact a Futaba Service Center.
 - Futaba is not responsible for the use of this product by the customer.
 - Company and product names in this manual are trademarks or registered trademarks of the respective company.

For safe use

Please observe the following precautions to ensure safe use of this product at all times.

Meaning of Special Markings:

The parts of this manual indicated by the following marks require special attention from the standpoint of safety.

- ⚠ **DANGER** - Procedures which may lead to dangerous conditions and cause death/serious injury if not carried out properly.
- ⚠ **WARNING** - Procedures which may lead to a dangerous condition or cause death or serious injury to the user if not carried out properly, or procedures where the probability of superficial injury or physical damage is high.
- ⚠ **CAUTION** - Procedures where the possibility of serious injury to the user is small, but there is a danger of injury, or physical damage, if not carried out properly.

⊘ = Prohibited ! = Mandatory

WARNING: Always keep electrical components away from small children.

Flying Precautions

⚠ WARNING

⊘ Never grasp the transmitter antenna while flying.

- The transmitter output may drop drastically.

! Always make sure that all transmitter stick movements operate all servos properly in the model prior to flight. Also, make sure that all switches, etc. function properly as well. If there are any difficulties, do not use the system until all inputs are functioning properly.

⊘ Never fly in range check mode.

- In the dedicated range test range check mode, the transmitter output range is reduced and may cause a crash.

⊘ While operating, never touch the transmitter with, or bring the transmitter near, another transmitter, a cellphone, or other wireless devices.

- Doing so may cause erroneous operation.

⊘ Do not point the antenna directly toward the aircraft during flight.

- The antenna is directional and the transmitter output is weakest. (The strength of the radio waves is greatest from the sides of the antenna.)

⊘ Never fly on a rainy day, when the wind is strong, or at night.

- Water could lead to failure or improper functionality and poor control of the aircraft which could lead to a crash.

⊘ Never turn the power switch off during flight or while the engine or motor is running.

- Operation will become impossible and the aircraft will crash. Even if the power switch is turned on, operation will not begin until transmitter and receiver internal processing is complete.

⊘ Do not start the engine or motor while wearing the neck strap.

- The neck strap may become entangled with the rotating propeller, rotor, etc. and cause a serious injury.

⊘ Do not fly when you are physically impaired as it could pose a safety hazard to yourself or others.

⊘ Do not fly at the following places:

- Near another radio control flying field.
- Near or above people.
- Near homes, schools, airports, stations, hospitals or other places where people congregate.
- Near high voltage lines, high structures, or communication facilities.

⊘ When setting the transmitter on the ground during flight preparations, do not stand it upright.

- The transmitter may tip over, the sticks may move and the propeller or rotor may rotate unexpectedly and cause injury.

⊘ Do not touch the engine, motor, or ESC during and immediately after use.

- These items may become hot during use.

! For safety, fly so that the aircraft is visible at all times.

- Flying behind buildings or other large structures will not only cause you to lose sight of the aircraft, but also degrade the RF link performance and cause loss of control.

! From the standpoint of safety, always set the fail safe function.

- In particular, normally set the throttle channel to idle. For a helicopter, set the throttle channel to maintain a hover.

! When flying, always return the transmitter set-up screen to the Home screen.

- Erroneous input during flight is extremely dangerous.

! Always check the remaining capacity of the transmitter and receiver batteries before each flying session prior to flight.

- Low battery capacity will cause loss of control and a crash.

! Always check operation of each control surface and perform a range test before each flying session. Also, when using the trainer function, check the operation of both the teacher and student transmitter.

- Even one incorrect transmitter setting or aircraft abnormality can cause a crash.

! Before turning on the transmitter:

1. Always move the transmitter throttle stick position to the minimum (idle) position.
2. Turn on the transmitter first and then the receiver.

! When turning off the transmitter's power switch after the engine or motor has stopped (state in which it will not rotate again):

1. Turn off the receiver power switch.
2. Then turn off the transmitter power switch.

- If the power switch is turned on/off in the opposite order, the propeller may rotate unexpectedly and cause a serious injury.

- Also always observe the above order when setting the fail safe function.

! When adjusting the transmitter, stop the engine except when necessary. In the case of a motor, disconnect the wiring that allows it to continue operation. When doing so, please exercise extreme caution. Ensure that the aircraft is secured and that it will not come into contact with anything or anyone. Ensure that the motor will not rotate prior to making any adjustments.

- Unexpected high speed rotation of the engine may cause a serious injury.

Battery and Charger Handling Precautions

*If you ignore the following safety precautions, it may cause a fire, ignition, over heating, explosion, the leakage of electrolyte fluid or getting an electric shock.

⚠ DANGER

⊘ Do not recharge a battery that is damaged, deteriorated, leaking electrolyte, or wet.

⊘ Do not use the charger in applications other than as intended.

⊘ Do not allow the charger or battery to become wet.

- Do not use the charger when it or your hands are wet. Do not use the charger in humid places.

⊘ Do not heat or short-circuit the battery.

⊘ Do not solder, repair, deform, modify, or disassemble the battery and/or battery charger.

⊘ Do not drop the battery into a fire or bring it near a fire or store them in a hot area.

⊘ Do not charge and store the battery in direct sunlight or other hot places.

⊘ Do not charge the battery if it is covered with any object as it may become very hot.

⊘ Do not apply excessive mechanical stress to it.

⊘ Do not use chargers other than those recommended by Futaba.

⊘ Do not use the battery in a combustible environment.

- The combustibles may could ignite and cause an explosion or fire.

■ Charging the battery past the specified value may cause a fire, combustion, rupture, or liquid leakage. When quick charging, do not charge the battery above 1C.

■ Do not charge the battery while riding in a vehicle. Vibration will prevent normal charging.

! Insert the power cord plug firmly into the receptacle up to its base.

! Always use the charger with the specified power supply voltage.

■ Use the special charger by connecting it to a proper power outlet.

⚠ WARNING

⊘ Do not touch the charger and battery for any length of time during charging.

■ Doing so may result in burns.

⊘ Do not use a charger or battery that has been damaged.

⊘ Do not touch any of the internal components of the charger.

■ Doing so may cause electric shock or a burn.

⊘ If any abnormalities such as smoke or discoloration are noted with either the charger or the battery, remove the battery from the transmitter or charger and disconnect the power cord plug and do not use the charger.

■ Continued use may cause fire, combustion, generation of heat, or rupture.

⊘ Do not subject the batteries to impact.

■ Doing so may cause fire, combustion, generation of heat, rupture, or liquid leakage.

⚠ CAUTION

⊘ Do not use the battery with devices other than the corresponding transmitter.

⊘ Do not place heavy objects on top of the battery or charger. Also, do not place the battery or charger in any location where it may fall.

■ Doing so may cause damage or injury.

⊘ Do not store or use the battery and charger where it is dusty or humid.

■ Insert the power cord plug into the receptacle only after eliminating the dust.

⊘ After the transmitter has been used for a long time, the battery may become hot. Immediately remove it from the transmitter.

! If the battery liquid should get in your eyes, do not rub your eyes, but immediately wash them with tap water or other clean water and get treated by a doctor.

■ The liquid can cause blindness.

! Keep the battery out of reach of children.

! Always charge the battery before each flying session.

■ If the battery goes dead during flight, the aircraft will crash.

! Charge the battery with the dedicated charger supplied with the set.

! Use and store the battery and battery charger in a secure location away from children.

■ Not doing so may cause electric shock or injury.

! If the battery leaks liquid or generates an abnormal odor, immediately move it to a safe place for disposal.

■ Not doing so may cause combustion.

! If the battery liquid gets on your skin or clothing, immediately flush the area with tap water or other clean water.

■ Consult a doctor. The liquid can cause skin damage.

! After the specified charging time has elapsed, end charging and disconnect the charger from the receptacle.

! When recycling or disposing of the battery, isolate the terminals by covering them with tape.

■ Short circuit of the terminals may cause combustion, generation of heat or rupture.

■ Not doing so may cause a burn.

⊘ Do not charge the battery in extreme temperatures.

■ Doing so will degrade the battery performance. An ambient temperature of 10°C to 30°C (50 °F to 86 °F) is ideal for charging.

⊘ Unplug the charger when not in use.

⊘ Do not bend or pull the cord unreasonably and do not place heavy objects on the cord.

■ The power cord may be damaged and cause combustion, generation of heat, or electric shock.

microSD Card (Commercial Product) Handling Precautions

*Read the instruction manual supplied with the microSD card for details.

⚠ WARNING

⊘ Never disassemble or modify the microSD card.

⊘ Do not bend, drop, scratch or place heavy objects on the microSD card.

⊘ If smoke or an abnormal odor emanates from the card, immediately turn off the transmitter power.

⚠ CAUTION

❗ Since the microSD card is an electronic device, be careful of static electricity.

- Static electricity may cause erroneous operation or other trouble.

⊘ Do not use the microSD card near radio and television sets, audio equipment, motors and other equipment that generates noise.

- Doing so may cause erroneous operation.

⊘ Do not store the microSD card in the following places:

- Where the humidity is high
- Where the temperature difference is severe
- Where it is very dusty
- Where the card will be exposed to shock and vibration

⊘ Do not use the microSD card where it may be exposed to water, chemicals, oil, or other fluids.

- Doing so may cause a fire or electric shock by short circuiting.

- Near speakers and other magnetic devices

⊘ Do not insert foreign matter into the transmitter card slot.

- Doing so may cause erroneous operation.

⊘ Do not expose the card to shock and vibration and do not remove the card from the card slot while data is being written or read.

- The data may be damaged or lost.

● Recorded data

The data recorded on the microSD card cannot be compensated regardless of the contents or cause of the trouble or obstruction. Futaba does not perform data restoration or recovery work.

Storage and Disposal Precautions

⚠ WARNING

⊘ Keep wireless equipment, batteries, aircraft, etc. away from children.

⚠ CAUTION

⊘ Do not store wireless devices in the following places:

- Where it is extremely hot (40°C [104 °F] or higher) or cold (-10°C [14 °F] or lower)
- Where the equipment will be exposed to direct sunlight
- Where the humidity is high
- Where vibration is prevalent
- Where it is very dusty
- Where the device may be exposed to steam and heat

❗ When the device will not be used for a long time, remove the batteries from the transmitter and aircraft and store them in a dry place where the temperature is between 0°C and 30°C [32 °F and 86 °F].

- Leaving batteries inside your model and radio when they are not being used for long periods will result in battery deterioration, liquid leakage and other damage.

Other Precautions

⚠ CAUTION

⊘ Do not directly expose plastic parts to fuel, oil, exhaust gas, etc.

- If left in such an environment, the plastic may be damaged.
- Since the metal parts of the case may corrode, always keep them clean.

❗ Join the Academy of Model Aeronautics.

- The Academy of Model Aeronautics (AMA) provides

guidelines and liability protection should the need arise.

❗ Always use genuine Futaba products such as transmitter, receiver, servo, ESC, battery, etc.

- Futaba is not responsible for damage sustained by combination with parts other than Futaba Genuine Parts. Use the parts specified in the instruction manual and catalog.

BEFORE USE

FEATURES

FASSTest system

The T32MZ transmitter adopted the bidirectional communication system "FASSTest". Data from the receiver can be checked in your transmitter. FASSTest is a maximum 18 channels (linear 16 channels + switch 2 channels) 2.4 GHz dedicated system.

Channel expansion (multiprop function)

The multiprop function can be used by using the separately sold multiprop decoder MPDX-1. The multiprop function is a function that divides one channel into eight channels and extends the number of channels. Up to 2 MPDX-1s can be used, and up to 32 channels can be expanded as follows.

- Linear channel 14 channels (2 channels are used by multi-prop function)
- ON/OFF channel 2 channels
- Multiprop channels 16 channels

Multiprop channels have the following differences from normal linear channels.

- The resolution of the multiprop channel is lower than that of the linear channel.
- Operating multiple multiprop channels simultaneously may reduce the operation response of the multiprop channel.
- Multiprop channels can not use the mixing function.

S.BUS2 system

By using the S.BUS2 system multiple servos, gyros and telemetry sensors are easily installed with a minimum amount of cables.

Windows Embedded Compact 7

T32MZ utilizes the world famous Microsoft Windows Embedded Compact 7, which offers outstanding dependability and valuable resources.

Color LCD Main display

T32MZ has a HVGA (640x240 pixels) full color backlight LCD touchscreen. The screen is manufactured of a transfective construction which enables both indoor and outdoor visibility.

Color LCD Sub display

T32MZ has a color LCD sub-display. It will be possible to know telemetry information separately from the main display. The sub display uses a reflective LCD with good visibility even outdoors.

Music Play

T32MZ can playback WMA (Windows Media Audio) files on a microSD-Card. You can enjoy music by the internal speaker or stereo headphones from the earphone jack. A switch can be assigned to start/stop your music.

Voice Recording

You can record your own voice using the internal microphone and then play back commands assigned to certain switches. Recording time is 3 seconds maximum and 24 voice files can be stored.

Secure Data (microSD)

Model data, music files, voice files and picture files can be stored on optional microSD card. The microSD card is also used when updating the software/features of the T32MZ.

High capacity lithium polymer battery (6600 mAh)

The high capacity Lithium Polymer battery gives you extended flight time.

Editing

The touch panel and Two enter keys allows you to edit your model in the manner that is easiest for you.

Functions

The internal dual processors operate the many 32MZ functions and optimize the response time. Most of the mixing functions are operated by curves which give you very precise settings.

Stick

Each axis is supported by dual ball bearings. And the magnetic detection type noncontact potentiometers was newly equipped. This allows for finer and more precise operation. Also, the throttle stick is an external screw adjustment, you can choose ratchet or spring self neutral.

Replaceable switches

You can replace 4 of the toggle switches on the right and left shoulder, with optional switches (two position, three position, and momentary etc.).

Vibration function

Low voltage and other alarms are generated by a vibration motor. Alarms or vibrations to be used can be selected by the owner.

R7108SB

The system comes with the R7108SB S.BUS2 Dual Antenna Diversity receiver featuring bi-directional communication.

Contents and Technical Specifications

(Specifications and ratings are subject to change without notice.)

Your 32MZ (packaged with an S.BUS receiver) includes the following components:

- T32MZ Transmitter
- R7108SB Receiver
- LT1F6600B Lithium-polymer battery & AC adapter
- Switch harness
- Tool Box (includes special jig for adjustment)
- Neck strap
- Transmitter case

The set contents depend on the type of set.

Transmitter T32MZ

Operating system: 2-stick, 18 channels, FASSTest/FASST/S-FHSS/T-FHSS system

Frequency band: 2.4 GHz

RF power output : 100 mW EIRP

Power supply: 3.8 V LT1F6600B Lithium-polymer battery

Receiver R7108SB

(FASSTest, S.BUS2, Diversity)

Receiving system: FASSTest system

Frequency band: 2.4 GHz

RF power output: 25 mW EIRP

Power requirement: 6.6 V LiFe battery

Current drain: 75 mA

Size: 24.9x47.3x14.3 mm

Weight: 12.0 g

Note: The T32MZ battery does not arrive plugged into the transmitter connector housing. Please connect the battery connector before use.

Transmitter controls

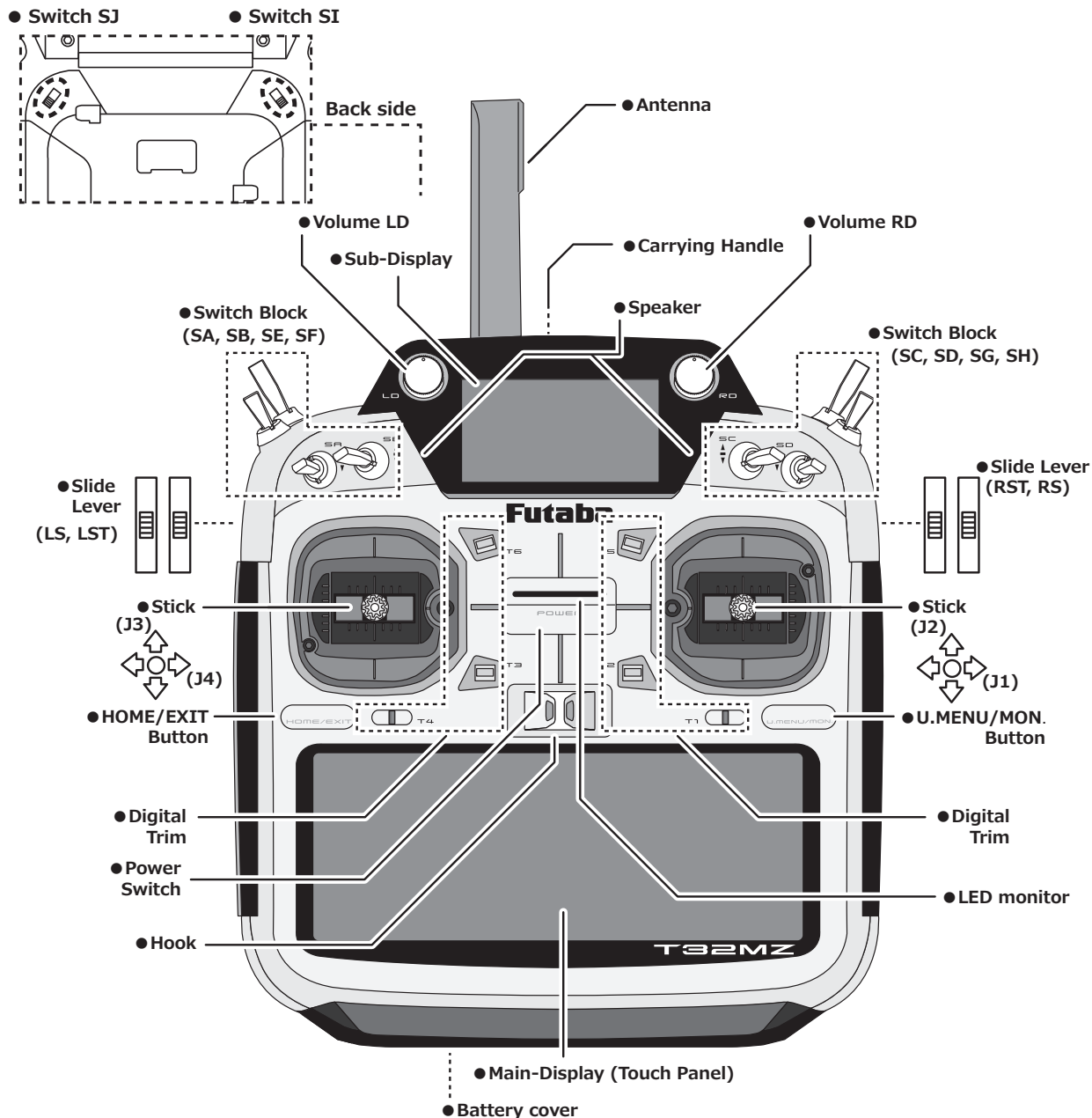

Cautions on handling antenna

⚠ WARNING

- ⊘ Do not touch the antenna during operation.
*There is the danger of erroneous operation causing a crash.
- ⊘ Do not carry the transmitter by the antenna.
*There is the danger that the antenna wire will break and operation will become impossible.
- ⊘ Do not pull the antenna forcefully.
*There is the danger that the antenna wire will break and operation will become impossible.

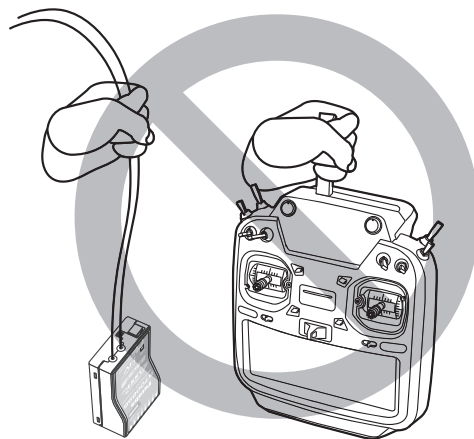

•Rotating antenna

The antenna can be rotated 90 degrees and angles 90 degrees. Forcing the antenna further than this can damage it. The antenna is not removable.

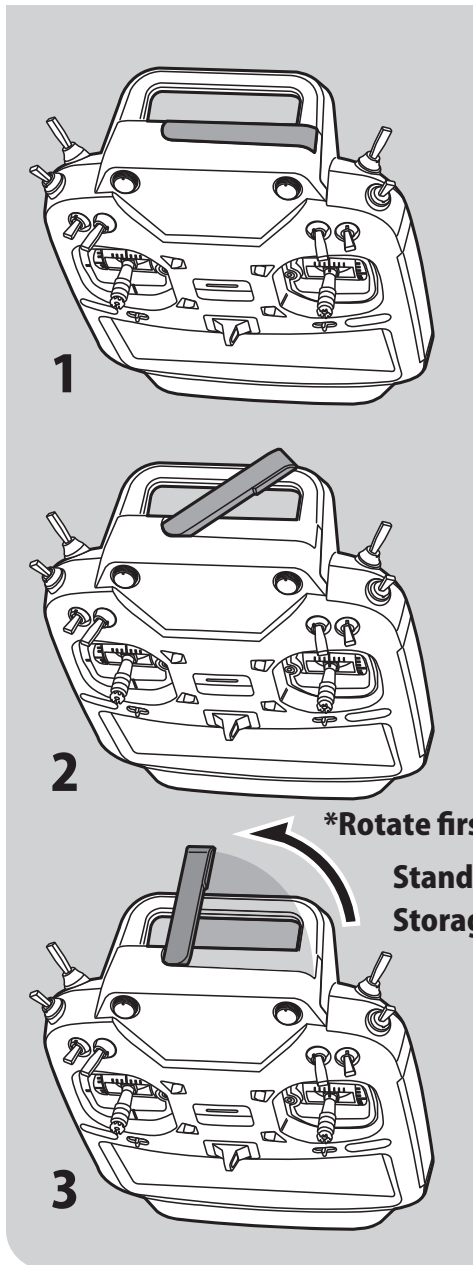

•Angle adjustment of the antenna

The antenna rotation and angle can be adjusted. The antenna features weak radio waves in the forward direction and strong radio waves in the sideways directions. Adjust the antenna angle to match your flying style.

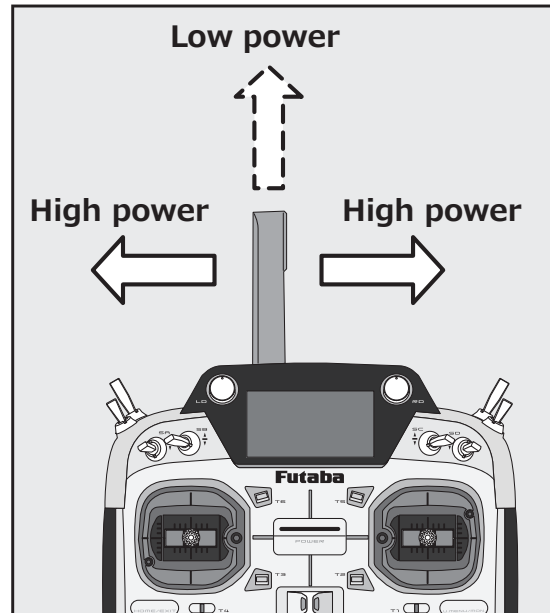

LED monitor

The status of the transmitter is displayed by changing the "MONITOR" section LED.

(LED Display)

- ◆ FASSTest mode → Light Blue light
- ◆ FASST mode → Green light
- ◆ S-FHSS/T-FHSS mode → yellow-green light
- ◆ RF-OFF → Violet light
- ◆ Starting → Red light
- ◆ Trainer Student → Blue light

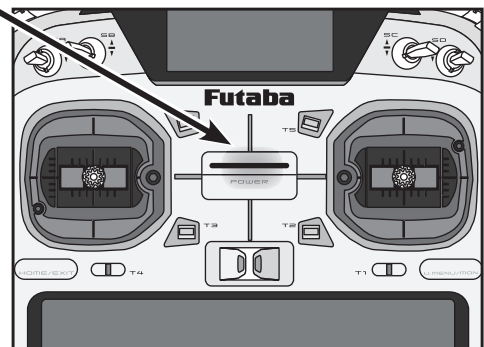

Toggle switch

8 switches can be assigned to each function.

- SA : 3 positions; Alternate; Short lever
- SB : 3 positions; Alternate; Long lever
- SC : 3 positions; Alternate; Long lever
- SD : 3 positions; Alternate; Short lever
- SE : 3 positions; Alternate; Short lever
- SF : 2 positions; Alternate; Long lever
- SG : 2 positions; Alternate; Short lever
- SH : 2 positions; Momentary; Long lever

*You can choose the Switch and the On/Off position in the Switch Selection menu of your mix.

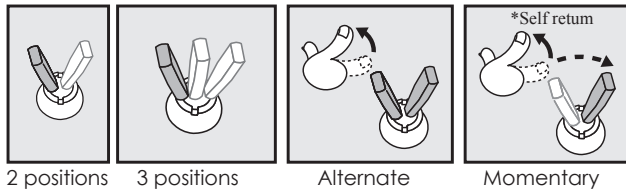

2 positions

3 positions

Alternate

Momentary

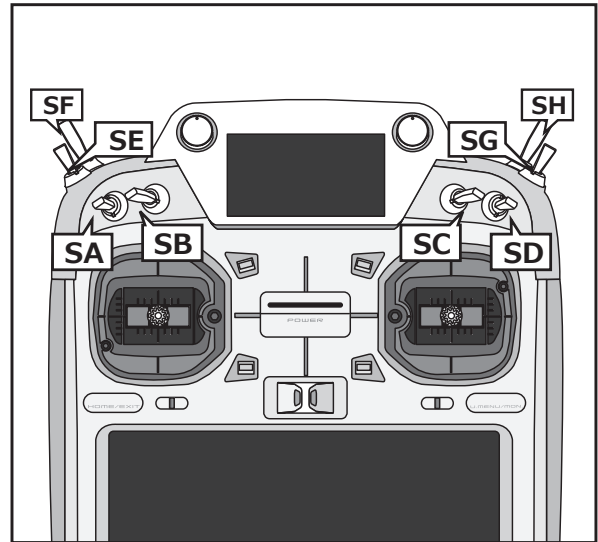

•When you change switches (SE, SF, SG, SH):

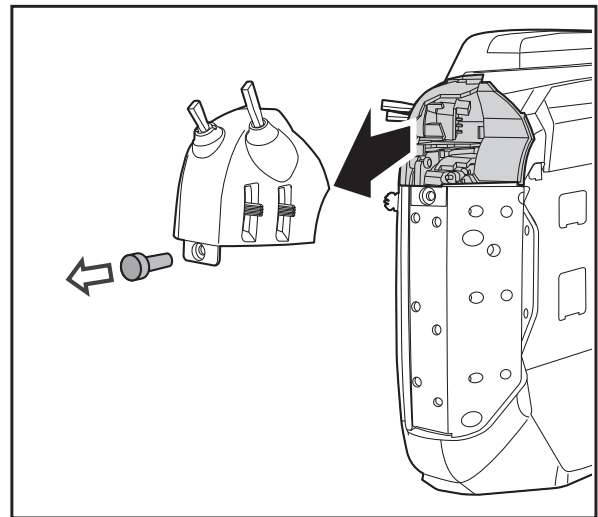
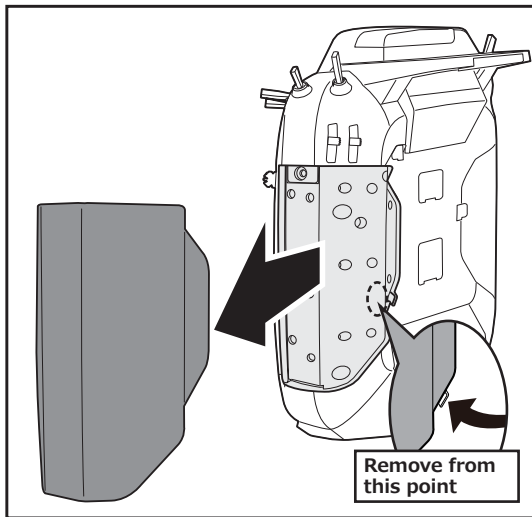

To relocate switches;

1. Make sure your transmitter is off, and remove the side rubber cover.
2. Use the driver to turn the screw counter-clockwise on the switch block and detach the block. Remove the screw holding the switch block. Pull the switch block remove.
3. Disconnect the connectors of switches you want to change.
4. Use the attached jig (inside stylus) to turn the face nuts counterclockwise, this will detach the switches.
5. To re-attach, use the face nuts to attach switches from other positions or optional switches to the switch block.
6. Connect your connectors.
7. Insert the switch block so reconnect the connectors that it fits correctly into the body of the transmitter and use the driver to tighten the screws.

Volume

Volume LD and RD:

Two volumes can be assigned to each function.

*It will beep when the lever is set to the center.

*You can check the position on the dial-monitor screen in the linkage menu.

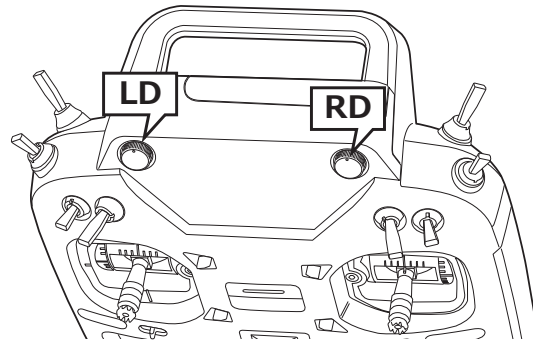

Back side switch

Switch SI, SJ:

You can choose switches and the ON/OFF-direction in the setting screen of the each functions.

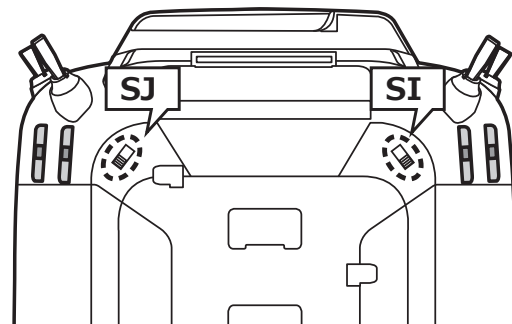

Slide Lever

LST (Left), RST (Right):

Outside levers

LS (Left), RS (Right):

Inside levers: Each lever has two ends, one at the front and the other at the back of the transmitter.

*It will beep when the lever is set to the center.

*You can check the lever position on the dial-monitor screen in the linkage menu.

*You can select a slide lever and set the movement direction on the setting screen of mixing functions.

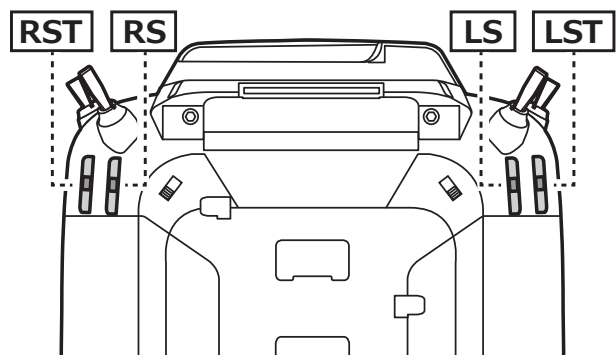
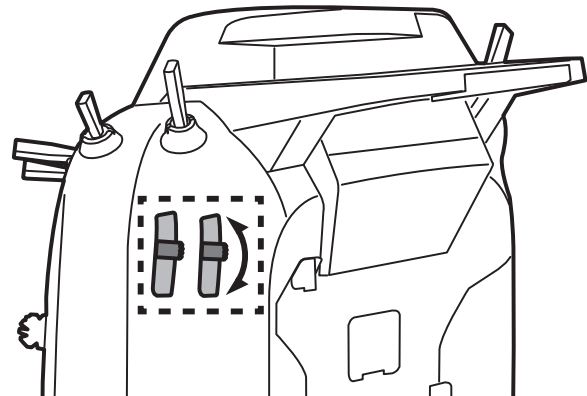

Digital trim

This transmitter is equipped with digital trims. Each time you press a trim button, the trim position moves one step. If you continue pressing it, the trim position starts to move faster. In addition, when the trim position returns to the center, the tone will change. You can always monitor trim positions graphics on the screen. To change the trim rate, you must activate this through the function menu, within the linkage menu. Touch the trim button and you will access another screen which enables you to change the trim percentages.

Note: The trim positions you have set will be stored in the non-volatile memory and will remain there.

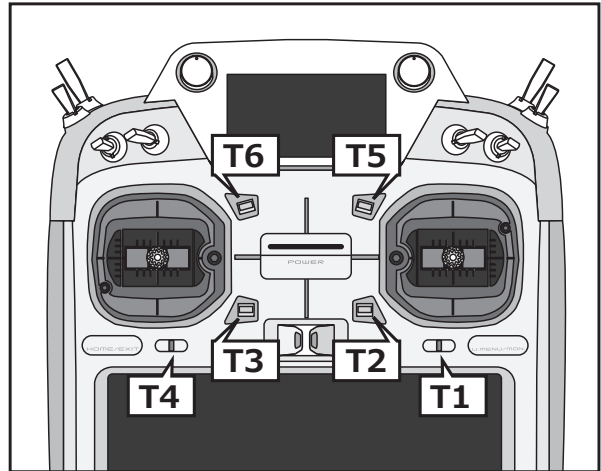

Touch Panel

Touch panel and HOME/EXIT & U.MENU/MON. button are used for entering data.

Touch the panel with your finger or the attached stylus pen, which is also used as a toolbox, to enter data.

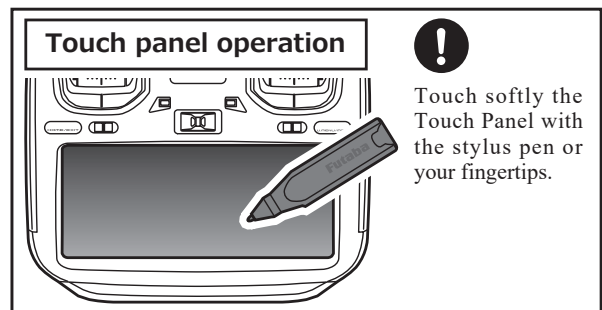
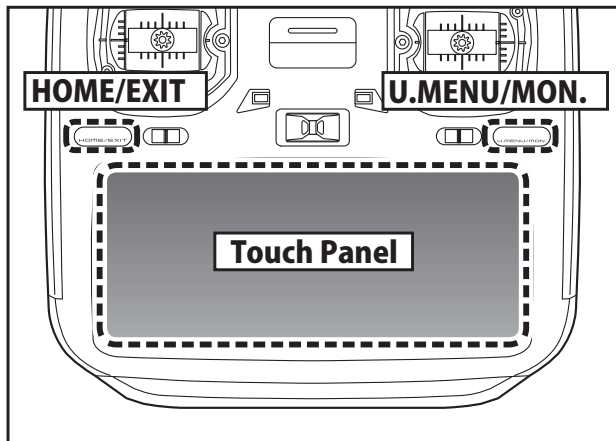

*Plastic film is attached to the touch panel. Please be careful so that you don't scratch the touch panel with anything hard such as a metal object. Don't push the touch panel with excessive force or drop anything on the panel.

*Although you may find some air bubbles under the plastic panel due to environmental changes such as temperature, it is not a defect and will cause no problems.

*Color LED is made from many pixels. Some pixels hold lighting. Moreover, some pixels go out. And a screen may flicker. Such condition is the characteristics of color LED. It is not failure.

⚠ DANGER

⚠ The T32MZ's touch screen is very sensitive. To avoid accidentally activating it during a flight, it is suggested that it be locked. Due to the touch screen's sensitivity, allowing it to be touched during flight by a neck strap hook, servo extension, or even your hand could be dangerous. Please use the touch panel lock for added safety during flight.

HOME/EXIT & U.MENU/MON. Button

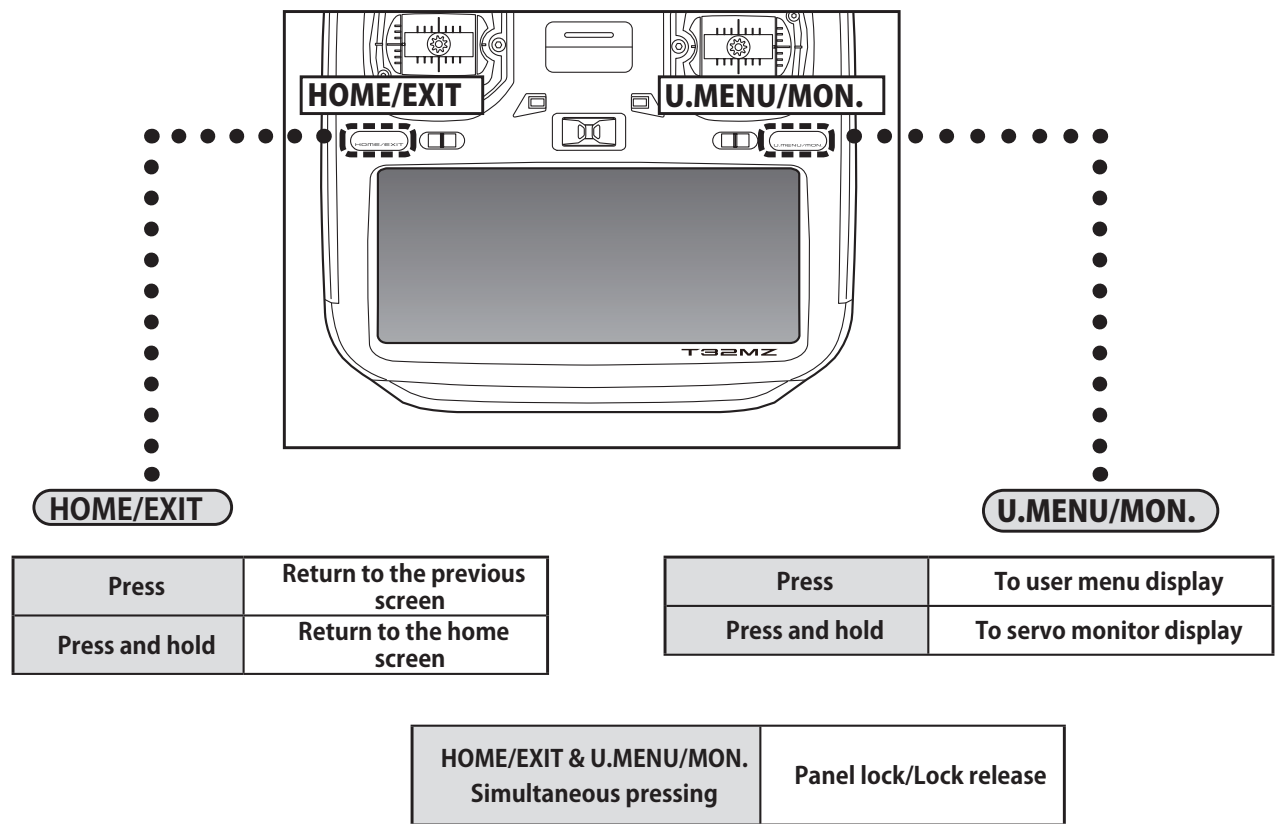

Stick Adjustment

Adjustment of the lever length

You can adjust the length of stick levers, if you like. It is recommended to adjust the length of the sticks in line with your hand size.

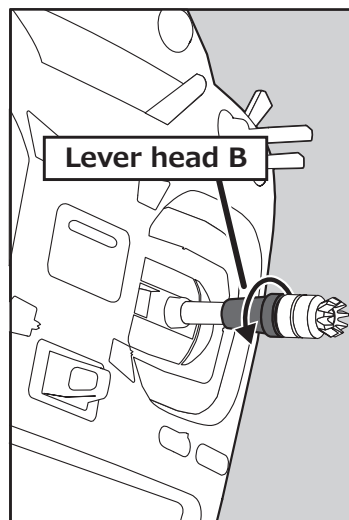
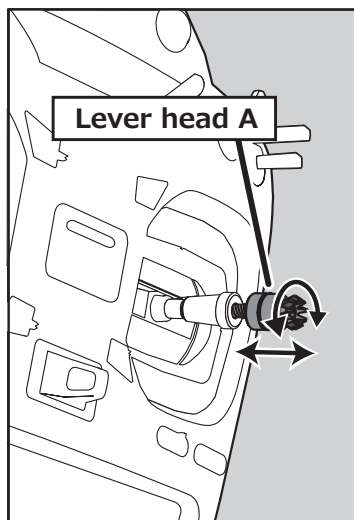

[How to adjust the Stick length.]

1. Hold the lever head "B" and turn the lever head "A" counter-clockwise, the lock will be released.
2. Adjust the stick lever to the desired length by turning lever head A.
3. Securely lock the stick lever by holding lever head A and turning lever head B counterclockwise.

Adjustment of the stick lever angle

You can make fine adjustments to the angle of a stick lever either inwards or outwards from the center stick position.

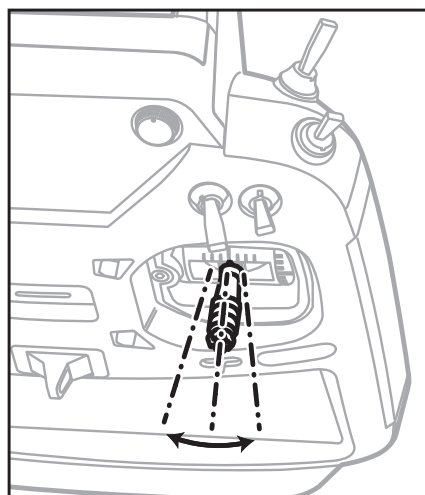
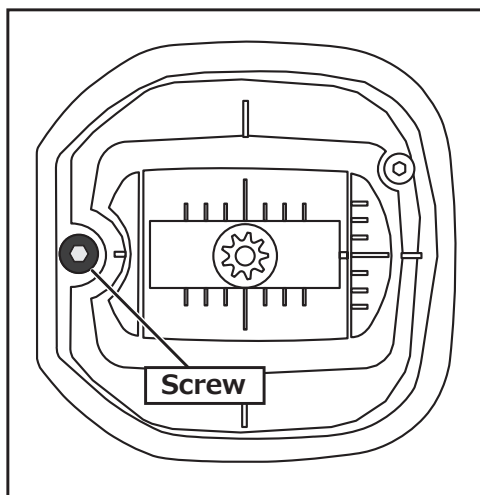

Use the attached 1.5 mm hexagonal wrench (inside stylus) to turn the screw clockwise to adjust the stick outwards, or counter-clockwise to tilt it inward.

Note: Be careful not to turn the screw too far counterclockwise as it could fall out.

Adjustment of Stick Lever Tension

You can adjust the tension of stick-levers.
The rubber cover in the back is removed first.

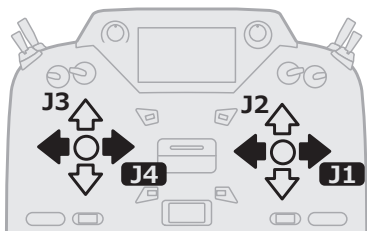
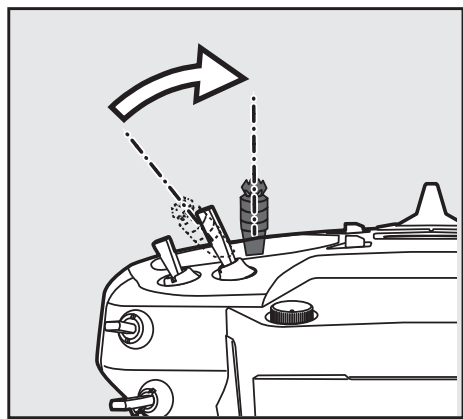
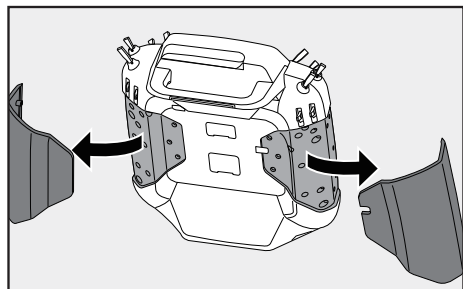

[Adjustment of tension]

Adjustment of Throttle Stick (Ratchet System)

You can choose either airplane ratchet system or helicopter-touch.

1. Open the dust protection cap on the back of the transmitter that is covering the hole for throttle stick adjustment.
2. Use the attached 1.5 mm hexagonal wrench (inside stylus) to turn the adjustment screw and set it as you prefer. Turning the screw clockwise increases the tension.

For airplanes: Adjust the screw on the left.

For helicopters: Adjust the screw on the right.

In changing the setting from airplane to helicopter (or heli to airplane);

1. Turn the screw counter-clockwise until the throttle stick moves freely, and turn the screw clockwise to adjust it to the tension you prefer.

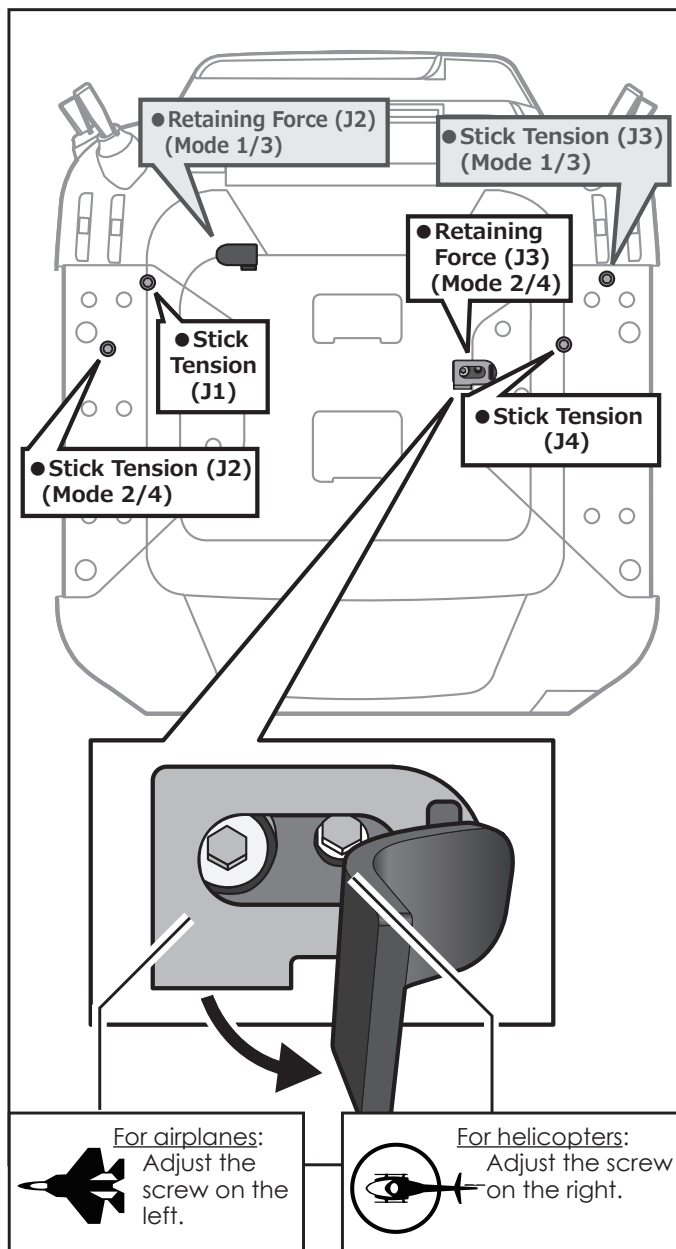

*In the Mode 1/3, arrangement of a screw is opposite.

*This transmitter has two ratchet plates, one for airplane and the other one for helicopter. If you tighten both screws, you won't be able to achieve the adjustment that you need because of the overlap of those two adjustments.

*If you want to change the setting from airplane to helicopter (or from helicopter to airplane), turn the ratchet screw clockwise until the throttle stick moves freely. Then turn the screw for the helicopter until you get the tension you like.

●Release of spring tension

The spring tension can be released by tightening the screw in the figure below.

e.g. Stick mode 2 → Stick mode 1

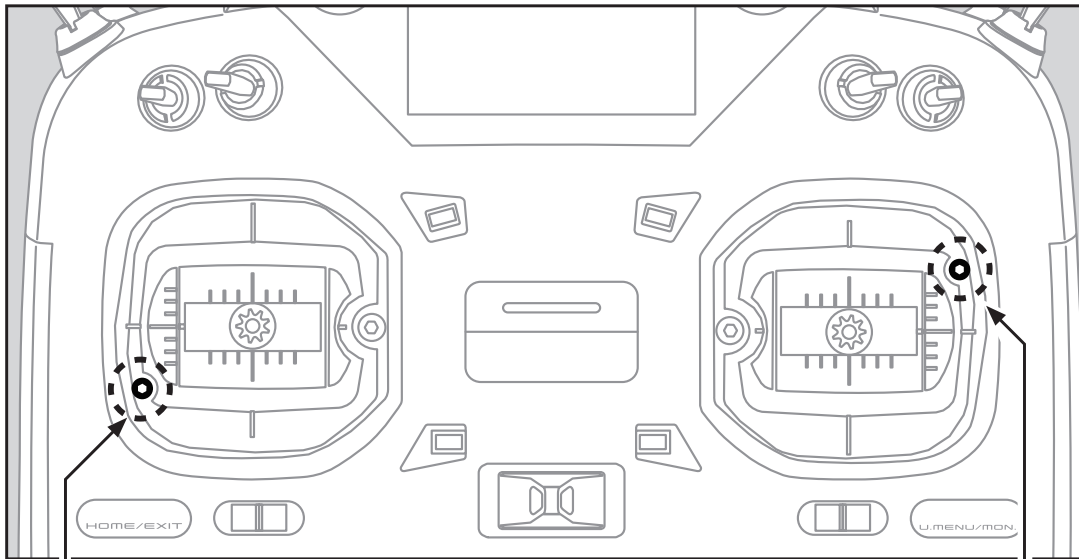

Loosen this screw and add spring tension.

Back side

Tighten this screw to release the spring tension.

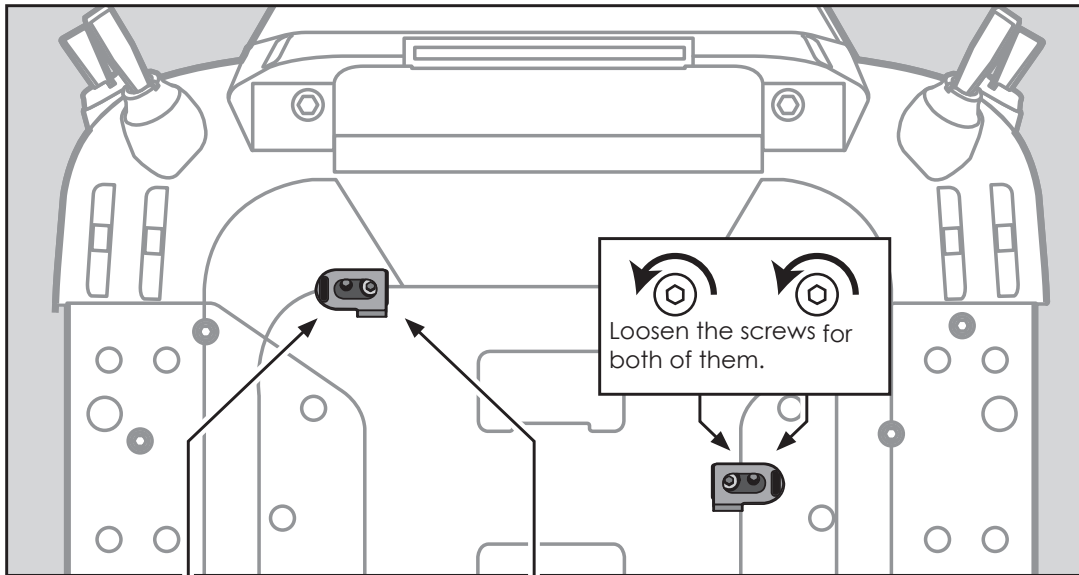

Loosen the screws for both of them.

For helicopters: Adjust the screw on the left.

For airplanes: Adjust the screw on the right.

●Next change the function
Change the function of Elevator-Throttle.
Linkage Menu → Function → SWAP

Battery exchange

Note: Detaching the battery while the power is on can cause data you have recently edited to be lost.

1. Open the battery cover by sliding as shown in the figure.

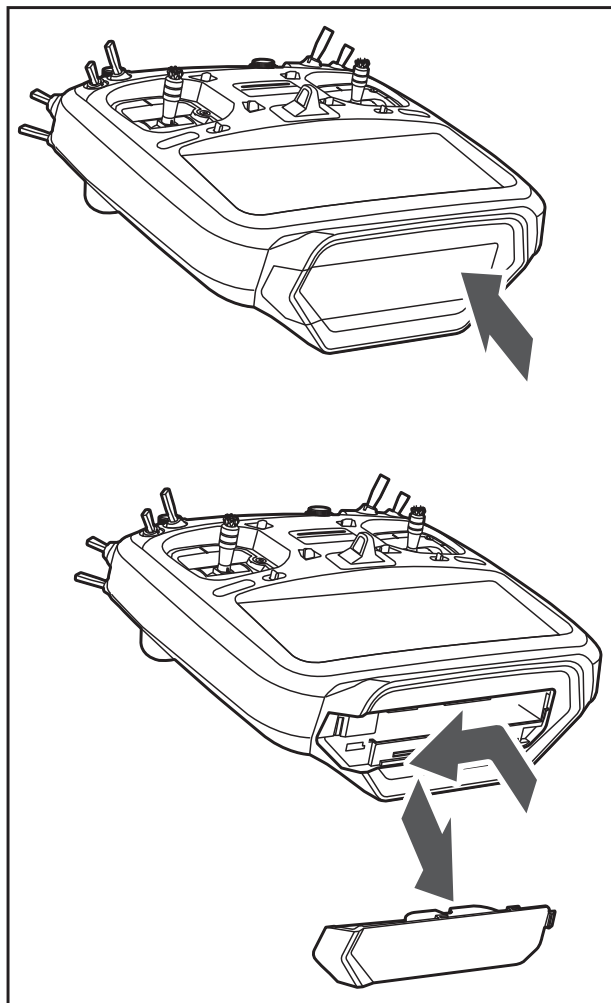

2. Pull out the Battery removal clip and slide out the battery.

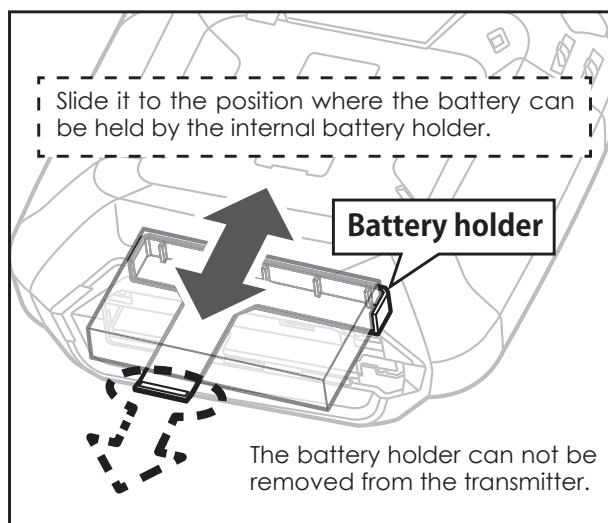
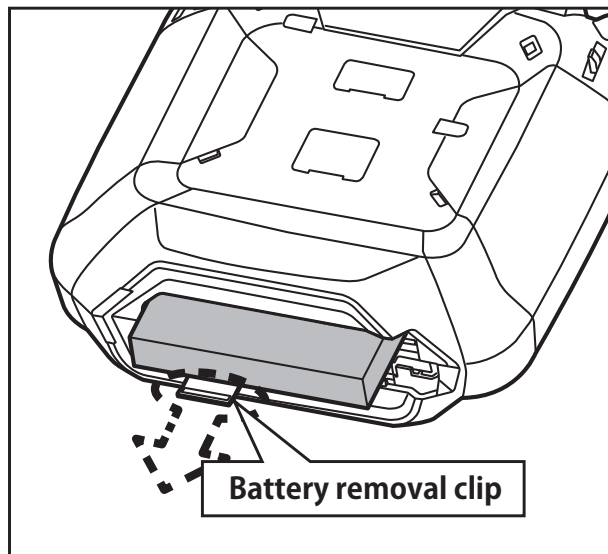

3. Remove the battery from the battery holder.

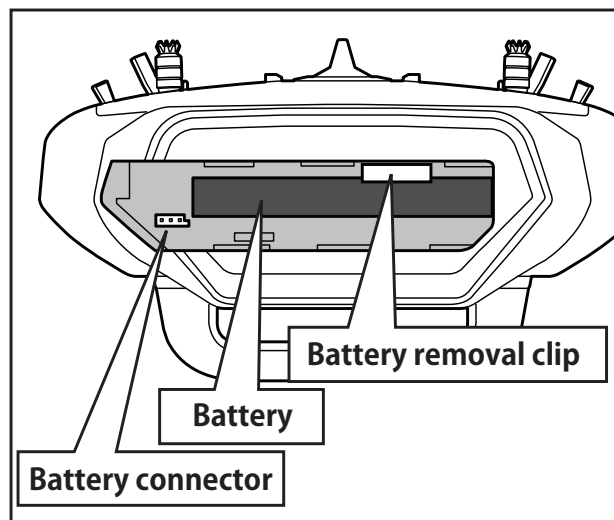
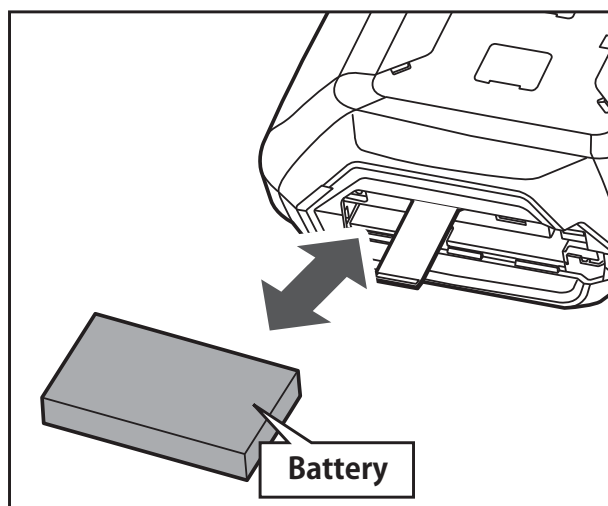

4. Connect the battery wiring as shown in the figure.

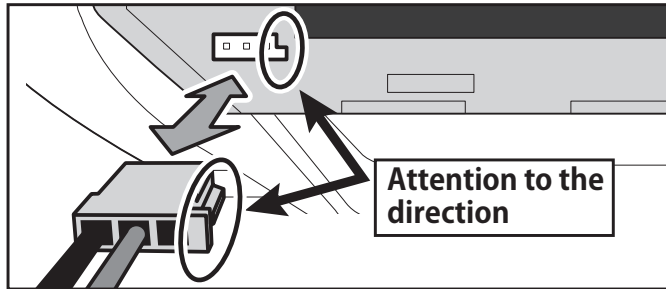

5. Slide and install the battery cover.

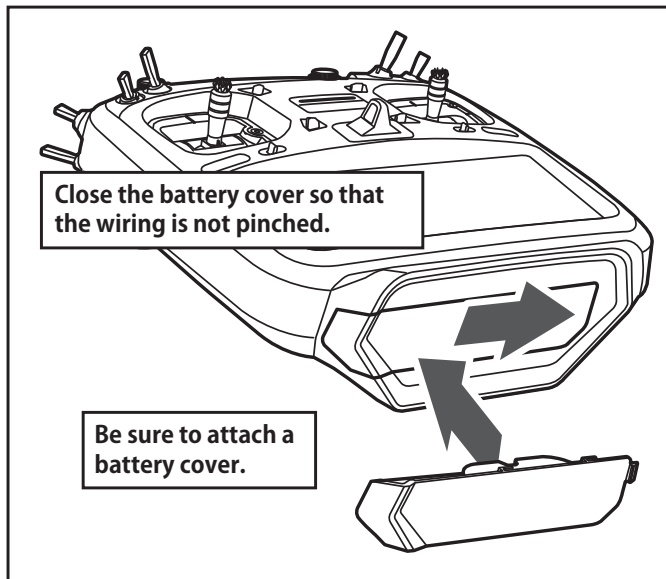

⚠ WARNING

- !** Be careful to not drop the battery.
- ⊘** Never take out the battery from the T32MZ transmitter while the LED monitor is blinking.
 - * Internal settings and memories can be destroyed.
 - * Do not use the transmitter if a “Backup Error” warning occurs. Send it to the Futaba Service Center to be checked.
- ⊘** Don't pull battery wiring.
 - *When it short-circuits, there is danger of explosion ignition.

Note: The T32MZ battery does not arrive plugged into the transmitter connector housing. Please connect the battery connector before use.

Battery Charging

1. Turn off the transmitter power.
2. Connect the power plug of the AC adapter to an AC outlet.

*Don't connect AC plug to the T32MZ without connecting with an AC outlet.

3. Open the back lid of the transmitter and insert the plug of the AC adapter into the CHG port.
4. The charging monitor of the transmitter lights red.

*In the case LCD screen will come on for several seconds and then go off. It may take several seconds for charging to start after the AC adapter is connected.

5. When the battery is fully charged the charge monitor will light off. Remove the charge plug and AC adaptor.

*After using the AC adapter always disconnect the power cord from the AC outlet.

*The time to charge a completely discharged battery pack is approximately 4 hours. However, the actual charging time may vary depending on temperature and state of the battery.

*If the battery is improperly installed or is faulty, the charging monitor will not light and the battery will not charge.

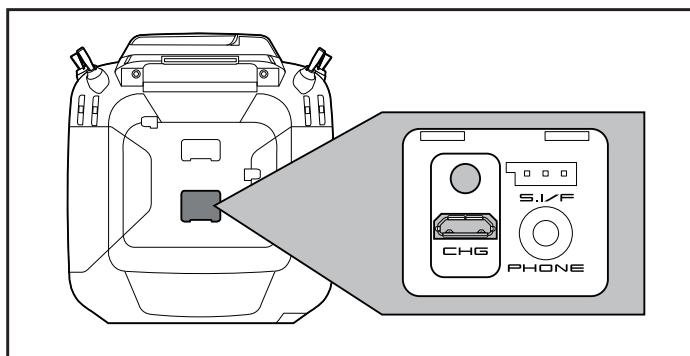

⚠ DANGER

- ⊘ The LT1F6600B lithium-polymer battery is for the T32MZ transmitter only. Do not use it with other devices.

- ⚠ Always use the included AC adapter to charge the battery. The charging circuit is built into the T32MZ.

⚠ WARNING

- ⊘ The transmitter battery cannot be charged with the receiver charger. Conversely the receiver battery cannot be charged with the transmitter charger.

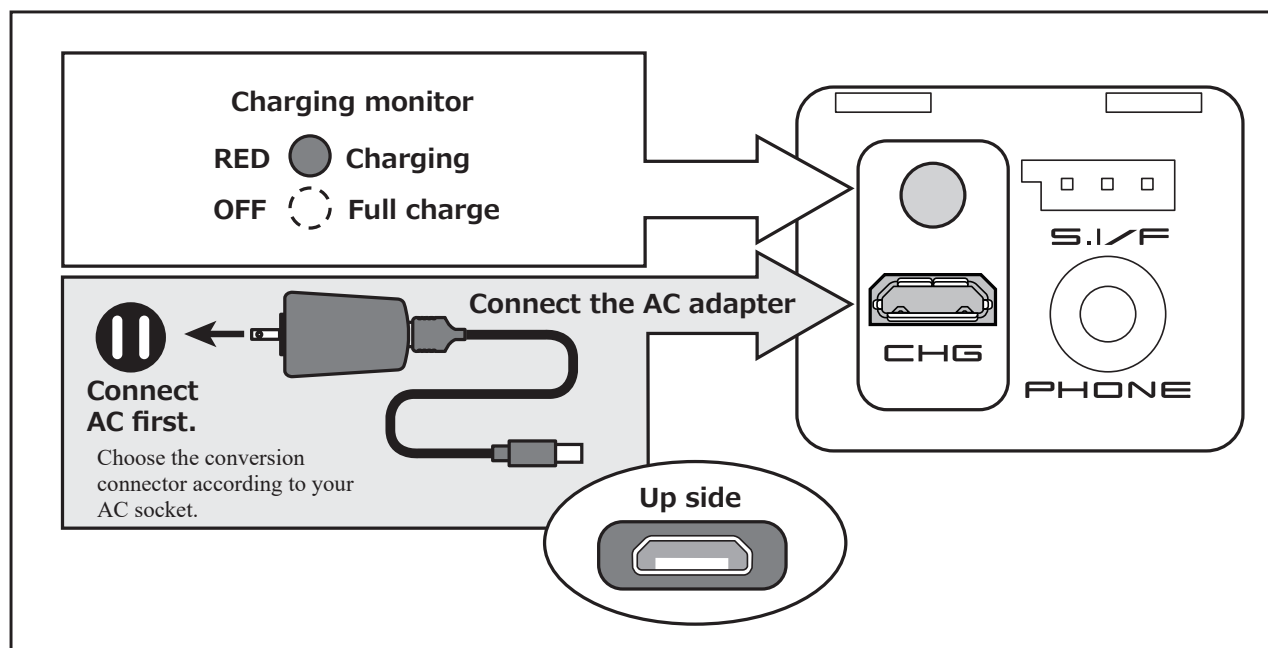

microSD Card (sold separately)

The microSD card can store various files, such as model data, music, sound files and pictures. Any microSD card on the market can be used with the T32MZ. The card is locked when it is pushed in all the way in. To remove the card, push in on the card again, it will pop up allowing you to remove it.

Model data of the microSD card is used for storage. Direct flight is not possible with microSD card model data. Copy to T32MZ and use it.

⚠ WARNING

- ❗ Be sure to turn off the power to the transmitter before inserting or removing the microSD card.
- ⊘ As the microSD card is a precision device, do not use excessive force when inserting.
- ❗ If model data generated by a new software version transmitter is copied to an old software version transmitter, the transmitter may operate erroneously. Copy the model data after updating the copy destination transmitter to the new software version.

Read data from a PC

Saving music and image files edited by a PC into the microSD card, you can use those files on your T32MZ transmitter. Equipment for reading and writing microSD cards are available at most electronics stores.

Stored data

The life of the microSD card is limited due to the use of flash memory. If you have a problem saving or reading data such as picture data after a long period of use you may need to purchase a new microSD card.

*We are not responsible for, and cannot compensate for any failure to the data stored in the memory card for any reason. Be sure to keep a backup of your models and data in your microSD card.

***No need for backup battery;** T32MZ transmitters and microSD cards are using nonvolatile memory devices so that the data stored in those will not be destroyed even without a backup battery. The clock for the transmitter depends on the Lithium battery.

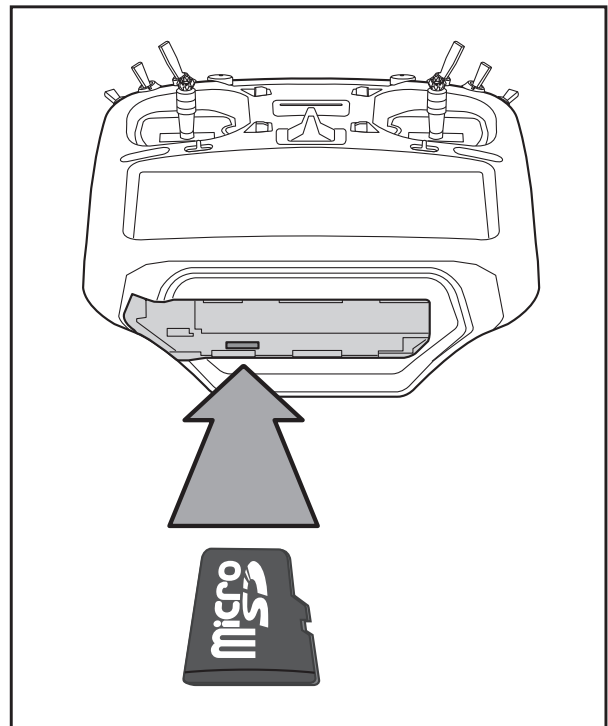
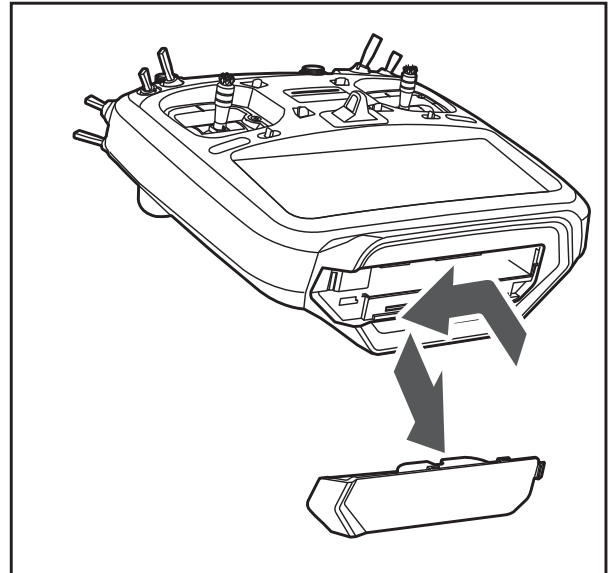

Connector for trainer function (TRAINER)

When you use trainer function, connect the optional trainer cable between the transmitters for teacher and student.

*You can set the trainer function on the Trainer Function screen in the system menu

S.BUS connector (S.I/F)

When setting an S.BUS servo or telemetry sensor, connect here.

Audio plug (PHONE)

Connecting a stereo headphone to this plug, you can enjoy music files stored in the microSD card.

Connector for battery charger (CHG)

You cannot use the charger that was included with the transmitter, without using the AC adapter that comes with this.

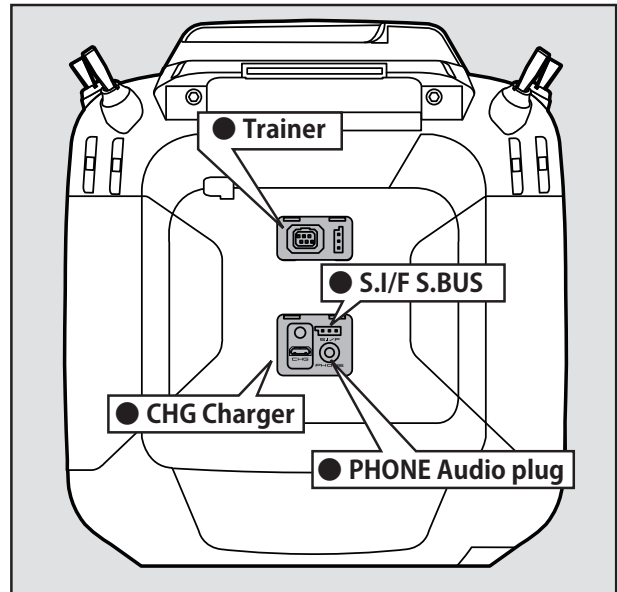

⚠ DANGER

- ⊘ Do not connect any other chargers. The charger for the receiver battery cannot be used for the transmitter.

CRSF Protocol for TBS

The T32MZ has been made compatible with the CRSF (TBS) protocol.

*Bidirectional communication function of CRSF is not supported.

⚠ WARNING

- ⊘ Futaba is not responsible for damage sustained by combination with parts other than Futaba Genuine equipment.

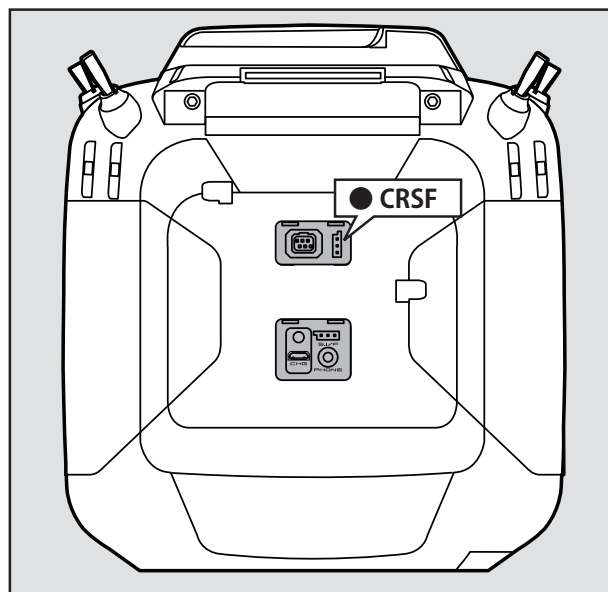

Receiver nomenclature

Before using the receiver, be sure to read the precautions listed in the following pages.

Receiver R7108SB

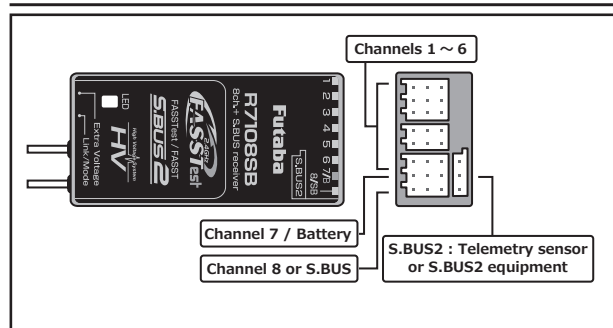

Connector

"1 through 6": outputs for the channels 1 through 6

"7/B": outputs of 7 channels and power.

"8/SB": outputs of 8 channels or S.BUS port.

[S.BUS Sevo S.BUS Gyro]

"S.BUS2": outputs of S.BUS2 port.

[Telemetry Sensor]

*When using nine or more channels, use an S.BUS function or use a second R7108SB and link both to your transmitter.

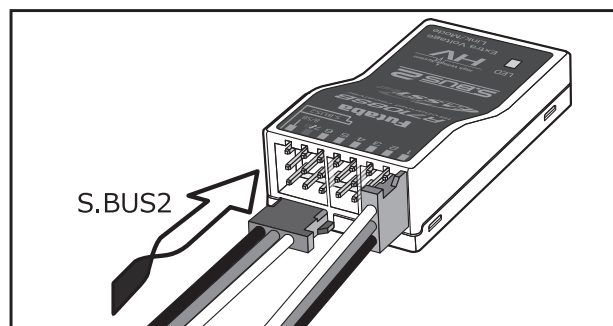

Connector insertion

Firmly insert the connector in the direction shown in the figure. Insert the S.BUS2 by turning it 90 degrees.

WARNING

S.BUS2 connectors

- Don't connect an S.BUS servo/gyro to BUS2 connector.

LED Monitor

This monitor is used to check the CH mode of the receiver.

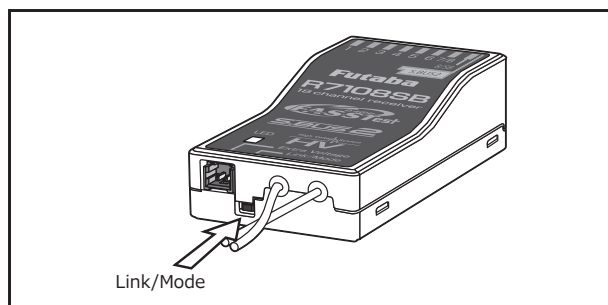

Link/Mode Switch

Use the small plastic screw driver that was included with your receiver.

The Link/Mode Switch is also used for the CH mode selection.

(The button is not used to link the transmitter and receiver together.)

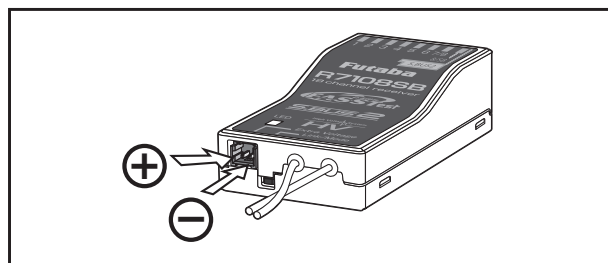

Extra Voltage Connector

Use this connector when using a voltage telemetry device to send the battery voltage (DC 0 ~ 70 V) from the receiver to the transmitter.

Please use an option is External voltage input cable. Wire in an extra connector to you drive batteries that mates with the extra voltage connector.

DANGER

- Don't touch wiring.
 - * There is a danger of receiving an electric shock.
- Do not short-circuit the battery terminals.
 - * A short circuit across the battery terminals may cause abnormal heating, fire and burns.
- Please double check your polarity (+ and -) when hooking up your connectors.
 - * If + and - of wiring are mistaken, it will damage, ignite and explode.
- Don't connection to Extra Voltage before turning on a receiver power supply.

Connection of a receiver battery

⚠ WARNING

- ⊘ Please make sure that you use a battery that can deliver enough capacity for the number and kind of servos used. Dry batteries cannot be used.

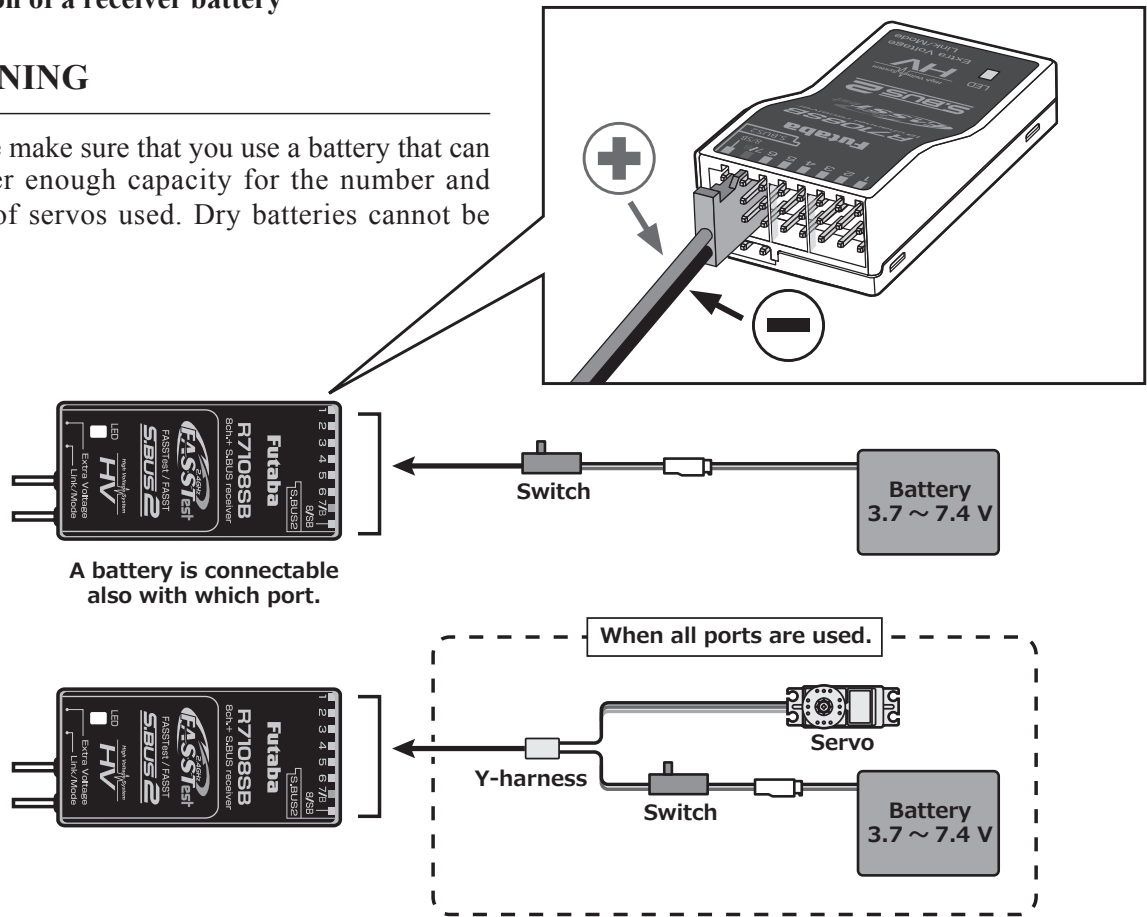

Connection example

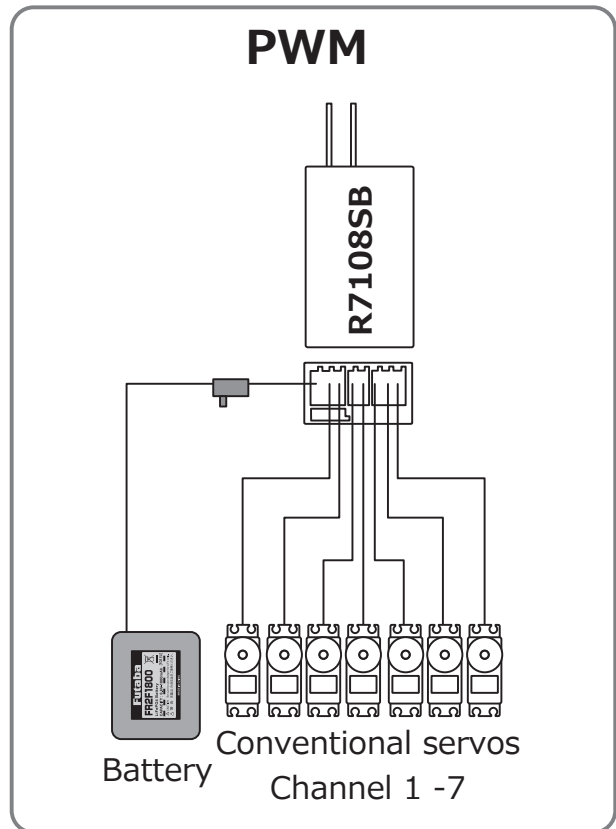
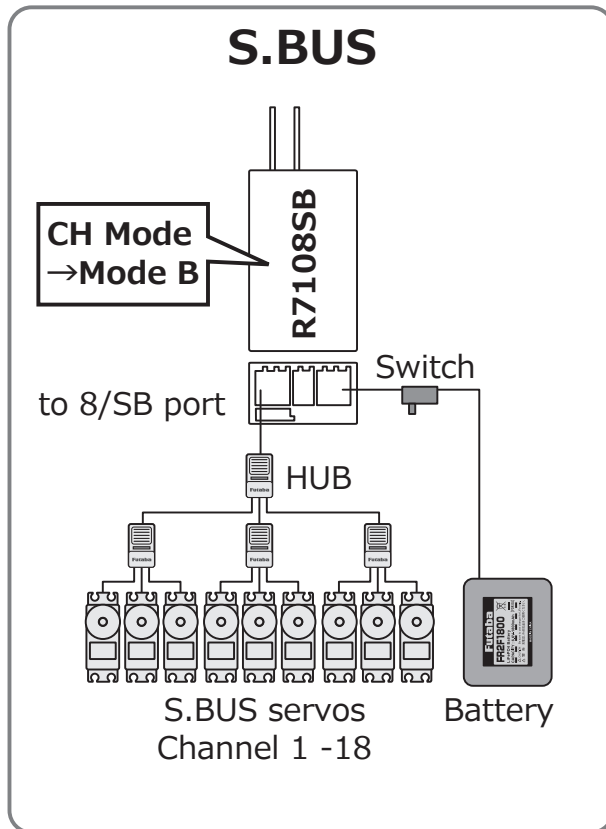

Channel Modes

The R7108SB is capable of changing its channel allocations as described in the table below. This is especially important when using the receiver in a dual receiver mode.

- 1 Turn on the receiver. [Transmitter is always OFF]
- 2 Press and hold the Link/Mode button for 5 seconds to 10 seconds.
- 3 When the LED of the receiver changes from blinking red to blinking red with green, Link/Mode button is released.
- 4 The LED should now blink red two times in the patterns described in the chart below.
- 5 Each press of the Link/Mode button advances the receiver to the next mode.
- 6 When you reach the mode that you wish to operate in, press and hold the Link/Mode button for more than 2 seconds. When LED blinks in green with red, it is the completion of a mode change, Link/Mode button is released.
- 7 Please cycle the receiver power off and back on again after changing the Channel mode.

R7108SB CH Mode table

Output connector	Channel			
	Mode A 1 ~ 8CH	Mode B 1 ~ 7CH	Mode C 9 ~ 16CH	Mode D 9 ~ 15CH
1	1	1	9	9
2	2	2	10	10
3	3	3	11	11
4	4	4	12	12
5	5	5	13	13
6	6	6	14	14
7/B	7	7	15	15
8/SB	8	S.BUS	16	S.BUS
Red LED blink	1 time	2 times	3 times	4 times

Default

LED Indication

System	Status	LED
FASSTest	No signal reception	Red Solid
	Receiving signals	Green Solid
	Waiting for link	Start → 2second later → Red Blink (1second)
FASST	No signal reception	Red Solid
	Receiving signals	Green Solid
	Receiving signals but ID is unmatched	Green Blink
	Waiting for link	Red Blink
FASSTest FASST	Unrecoverable error (EEPROM, etc.)	Alternate blink

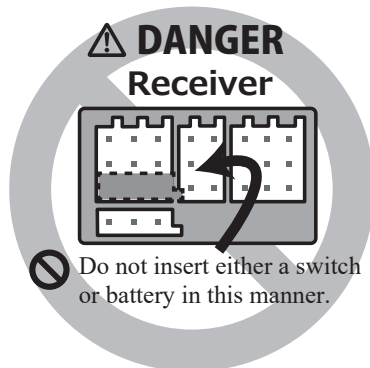

Systems (FASSTest ↔ FASST) change method

- 1 Turn on the receiver. [Transmitter is always OFF]
- 2 Press and hold the Link/Mode button for 10 seconds to 15 seconds.
- 3 When the LED begins to blink green the button may be released.
- 4 The LED should now be blinking green in one of the patterns described by the chart below.
(Default : FASSTest)
- 5 Each press of the Link/Mode button advances the receiver to the next system.
- 6 When you reach the system that you wish to operate in, press and hold the Link/Mode button for more than 2 seconds. When the LED blinks green and red, the system change is complete. Release the Link/Mode button.
- 7 Please cycle the receiver power off and back on again after changing the system.

R7108SB System table

Green LED blink	System
1 time	FASSTest ;Default
2 times	FASST Multi-ch Normal mode
3 times	FASST Multi-ch High-speed mode
4 times	FASST 7ch Normal mode
5 times	FASST 7ch High-speed mode

*FASST mode cannot use telemetry functions.

Servo (Option) · Toolbox · Receiver Switch

Servo (Option)

Purchase servos appropriate for their intended use.

***Analog servos** may not be used when operating in the **FASSTest 12CH mode**.

When operating in the **FASSTest12CH mode** use **digital servos**, this includes all **brushless** and **S.BUS servos**.

Toolbox

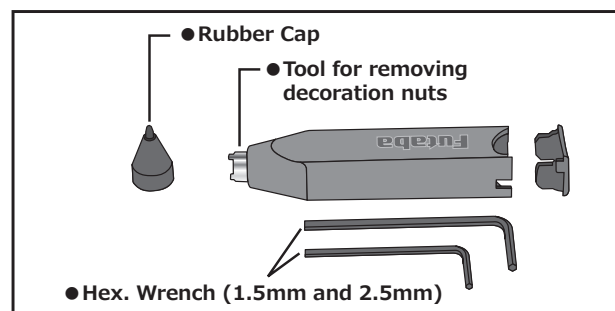

A special toolbox is included with your T32MZ. This allows you to make all of the mechanical adjustments that may be needed.

Hexagonal wrench (1.5 mm and 2.5 mm)

These wrenches are for adjustment of sticks and replacement of the switches.

Tool for removing switch nuts.

This is used when changing or replacing switches.

Stylus pen

A rubber cap is attached to the stylus pen/toolbox. You may use this stylus with rubber cap when operating the touch panel. The stylus allows more precise operation than fingers without fear of damaging the panels surface.



Receiver Switch ESW-1J

ESW-1J connects a Futaba receiver to a battery and is turned on and off in an FET circuit. Compared to using a mechanical switch, it allows more current to be sent with less loss.

Use the mounting plate from the receiver on/off switch as a template for the cutout and screw holes. Mount the switch on the side of the fuselage opposite the engine exhaust, and where it won't be inadvertently turned on or off during handling or storage. Be certain the switch moves without restriction and "snaps" from ON to OFF, and that the cutout allows full motion of the switch in both directions.

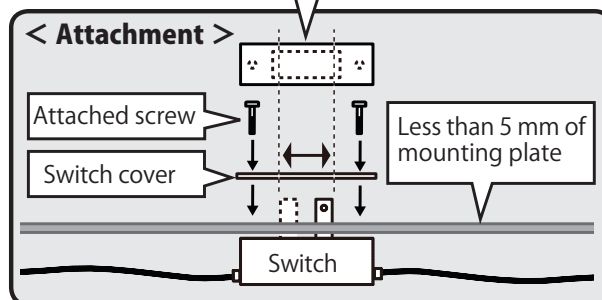

⚠ WARNING

When the model is not being used, always remove or disconnect the battery.

■ When the switch is off, a slight amount of current still flows. Unless the switch and battery are disconnected, the battery will be damaged from excessive discharge.

Always make sure that the switch harness is firmly attached to the fuselage of the model.

■ There is the danger of loss of control and crashing if the connector is disconnected by vibration and shock.

Do not charge the receiver battery through the switch harness. Disconnect the receiver battery and charge to the manufactures instructions.

■ There is no charge connector in this switch.

Never reverse the battery polarity.

■ Reverse connection will immediately destroy the receiver, servo, etc.

Ensure that the unit is mounted in an area that will eliminate exposure to fuel, water and vibration.

■ As with any electronic components, proper precautions are urged to prolong the life and increase the performance of the ESW-1J.

Allow a slight amount of slack in the cables and fasten them at a suitable location to prevent any damage from vibration during flight.

Never solder the ESW-1J or attempt to repair, deform, modify or disassemble them.

Do not use the ESW-1J with anything other than an R/C model.

Receiver's Antenna Installation

The R7108SB has two antennas. In order to maximize signal reception and promote safe modeling Futaba has adopted a diversity antenna system. This allows the receiver to obtain RF signals on both antennas and fly problem-free.

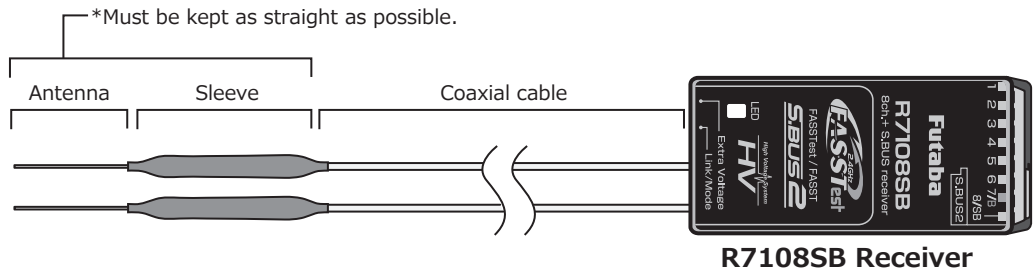

To obtain the best results of the diversity function, please refer to the following instructions:

1. The two antennas must be kept as straight as possible. Otherwise it will reduce the effective range.
2. The two antennas should be placed at 90 degrees to each other.
 - This is not a critical figure, but the most important thing is to keep the antennas away from each other as much as possible.
 - Larger models can have large metal objects that can attenuate the RF signal. In this case the antennas should be placed at both sides of the model. Then the best RF signal condition is obtained at any flying attitude.
3. The antennas must be kept away from conductive materials, such as metal, carbon and fuel tank by at least a half inch. The coaxial part of the antennas does not need to follow these guidelines, but do not bend it in a tight radius.
4. Keep the antennas away from the motor, ESC, and other noise sources as much as possible.

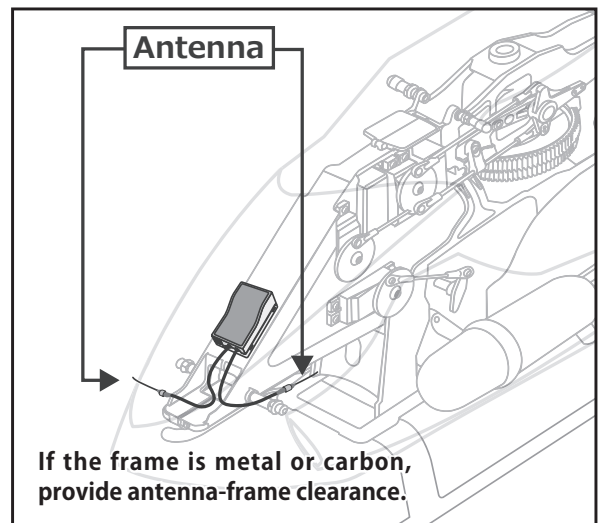
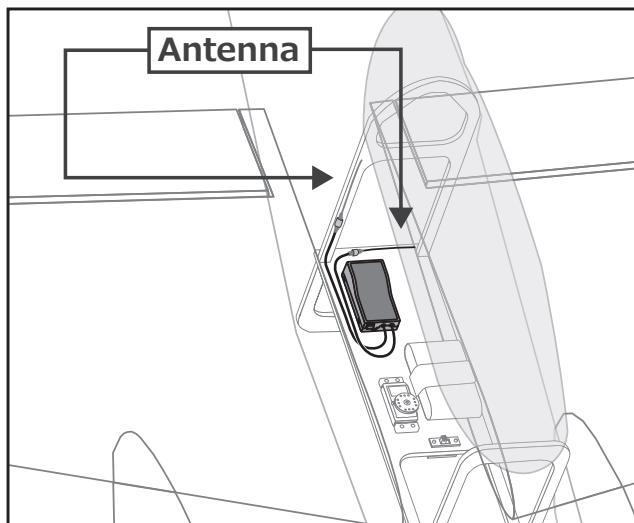
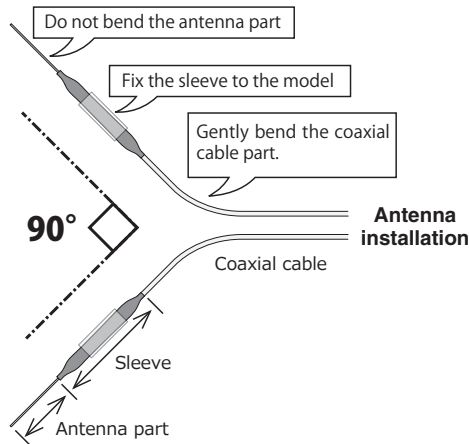

- *The two antennas should be placed at 90 degrees to each other.
- *The Illustration demonstrates how the antenna should be placed.
- *Receiver Vibration and Waterproofing: The receiver contains precision electronic parts. Be sure to avoid vibration, shock, and temperature extremes. For protection, wrap the receiver in foam rubber or other vibration-absorbing materials. It is also a good idea to waterproof the receiver by placing it in a plastic bag and securing the open end of the bag with a rubber band before wrapping it with foam rubber. If you accidentally get moisture or fuel inside the receiver, you may experience intermittent operation or a crash. If in doubt, return the receiver to our service center for repair.

Safety precautions when you install receiver and servos

Mounting the Servo

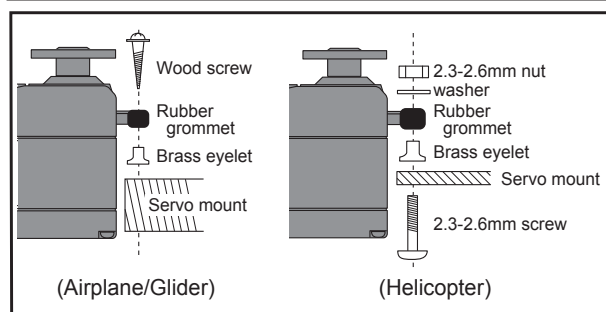

Servo lead wires

To prevent the servo lead cable from being broken by vibration during flight, provide a little slack in the cable and fasten it at suitable points. Periodically check the cable during daily maintenance.

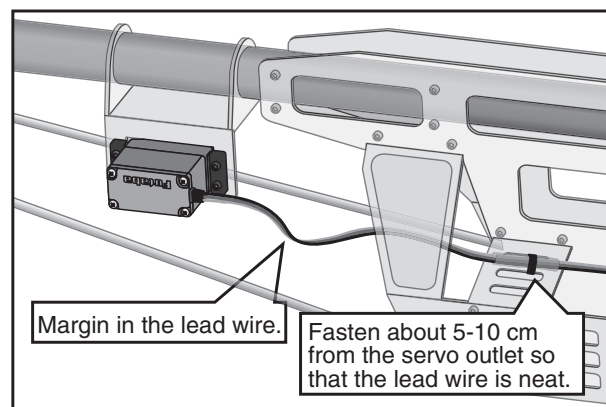

Mounting the power switch

When mounting a power switch to an airframe, make a rectangular hole that is a little larger than the total stroke of the switch so that you can turn the switch ON/OFF without binding.

Avoid mounting the switch where it can be covered by engine oil and dust. In general, it is recommended to mount the power switch on the side of the fuselage that is opposite the muffler.

⚠ WARNING

Connecting connectors

- ❗ Be sure to insert the connector until it stops at the deepest point.

How to protect the receiver from vibration and water

- ❗ Wrap the receiver with something soft such as foam rubber to avoid vibration. If there is a chance of it getting wet, put the receiver in a waterproof bag or balloon to avoid water.

Receiver's antenna

- ⊘ Never cut the receiver's antenna. Do not bind the receiver's antenna with the cables for servos.

- ❗ Locate the receiver's antenna as far as possible from metals or carbon fiber components such as frames, cables, etc.

*Cutting or binding the receiver's antenna will reduce the radio reception sensitivity and range, and may cause a crash.

Servo throw

- ❗ Adjust your system so that pushrods will not bind or sag when operating the servos to the full extent.

*If excessive force is continuously applied to a servo, the servo could be damaged due to force on the gear train and/or power consumption causing rapid battery drain.

Mounting servos

- ❗ Use a vibration-proof rubber (such as rubber grommet) under a servo when mounting the servo on a servo mount. And be sure that the servo cases do not touch directly to the metal parts such as servo mount.

*If the servo case contacts the airframe directly, vibration will travel to and possibly damage the servo.

S.BUS Installation

This set uses the S.BUS system. The wiring is as simplified and clean mounting as possible, even with models that use a large number of servos. In addition, the wings can be quickly installed to the fuselage without any erroneous wiring by the use of only one simple wire, even when there are a large number of servos used.

- When using S.BUS, special settings and mixes in your transmitter may be unnecessary.
- The S.BUS servos and S.BUS gyros memorize the number of channels themselves. (Settable with the T32MZ)
- The S.BUS system and conventional system (receiver conventional CH used) can be mixed.

S.BUS Glider usage example

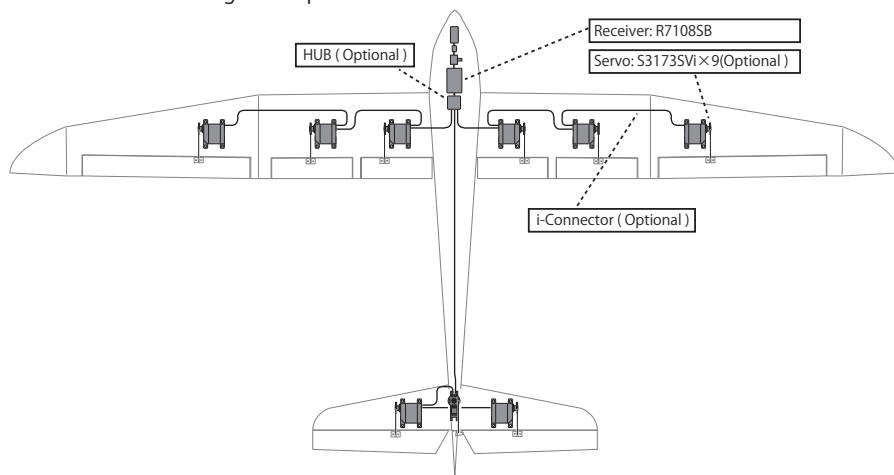

S.BUS Aerobatic plane usage example

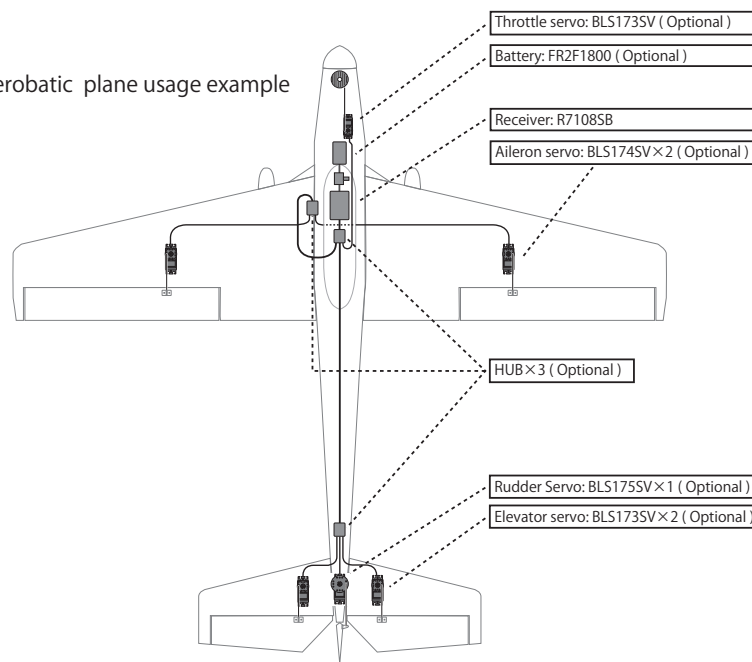

S.BUS2 System

When using the S.BUS2 port, an impressive array of telemetry sensors may be utilized.

S.BUS2 TABLE

Receiver port	S.BUS Servo S.BUS Gyro	S.BUS2 Servo S.BUS2 Gyro	Telemetry sensor
S.BUS	○	○	×
S.BUS2	×	○	○

(※) Don't connect S.BUS Servo, S.BUS Gyro to S.BUS2 connector.

S.BUS servos and gyros and S.BUS2 servos and gyros must be used in the correct receiver ports. Please refer to the instruction manual to make sure you connect to the correct one.

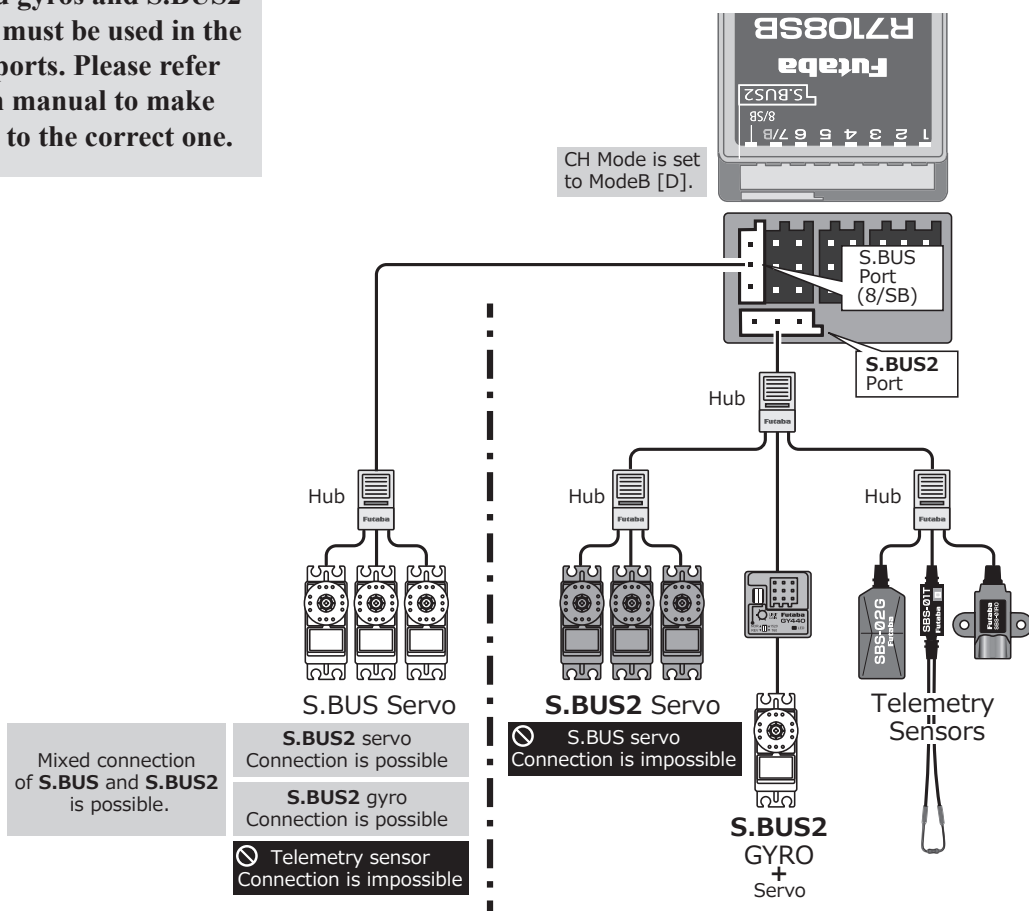

S.BUS device setting

S.BUS servos or a telemetry sensor can be connected directly to the T32MZ. Channel setting and other data can be entered for the S.BUS servos or sensors.

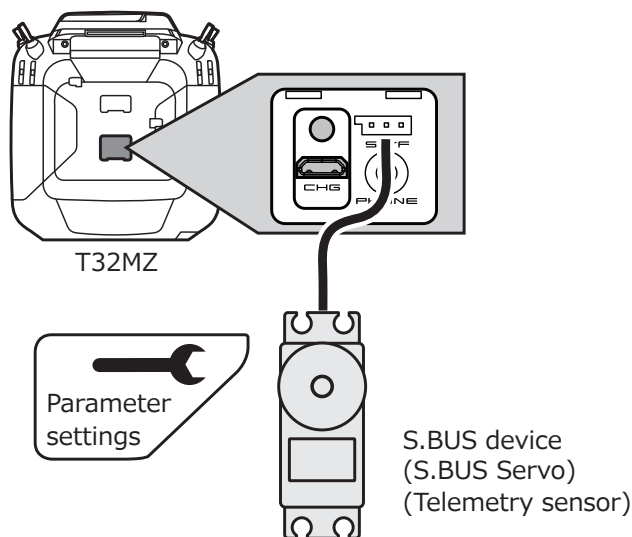

It is not necessary to carry out multiple battery connections like a T18MZ.

1. Connect the S.BUS device as shown in the figure.
2. Turn on the transmitter power.
3. Call the setup screen.
 - Servo: System Menu → S.BUS Servo
 - Sensor: Linkage Menu → Sensor
4. Perform setting in accordance with each screen.
5. This sets the channel and other data for each S.BUS servo, or telemetry device to be used with the S.BUS device or receiver.

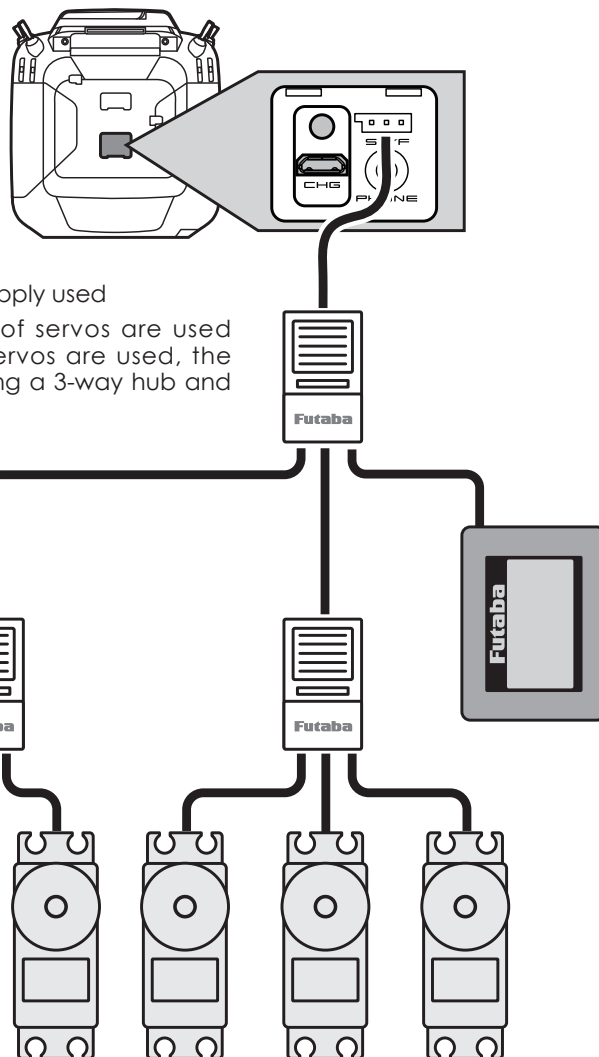

- When separate power supply used
When a large number of servos are used or when high current servos are used, the servos can be driven using a 3-way hub and receiver battery.

Telemetry System

The R7108SB receiver features bi-directional communication with a FASSTest Futaba transmitter using the S.BUS2 port. Using the S.BUS2 port an impressive array of telemetry sensors may be utilized. It also includes both standard PWM output ports and S.BUS output ports.

*Telemetry is available only in the FASSTest 18CH/T-FHSS mode. (FASSTest 12CH mode displays only Receiver battery voltage and Extra battery voltage.)

*The telemetry function requires the corresponding receiver.

*Each receiver has its own unique guid (globally unique identifier) or ID code for the transmitter to remember and recognize when in use.

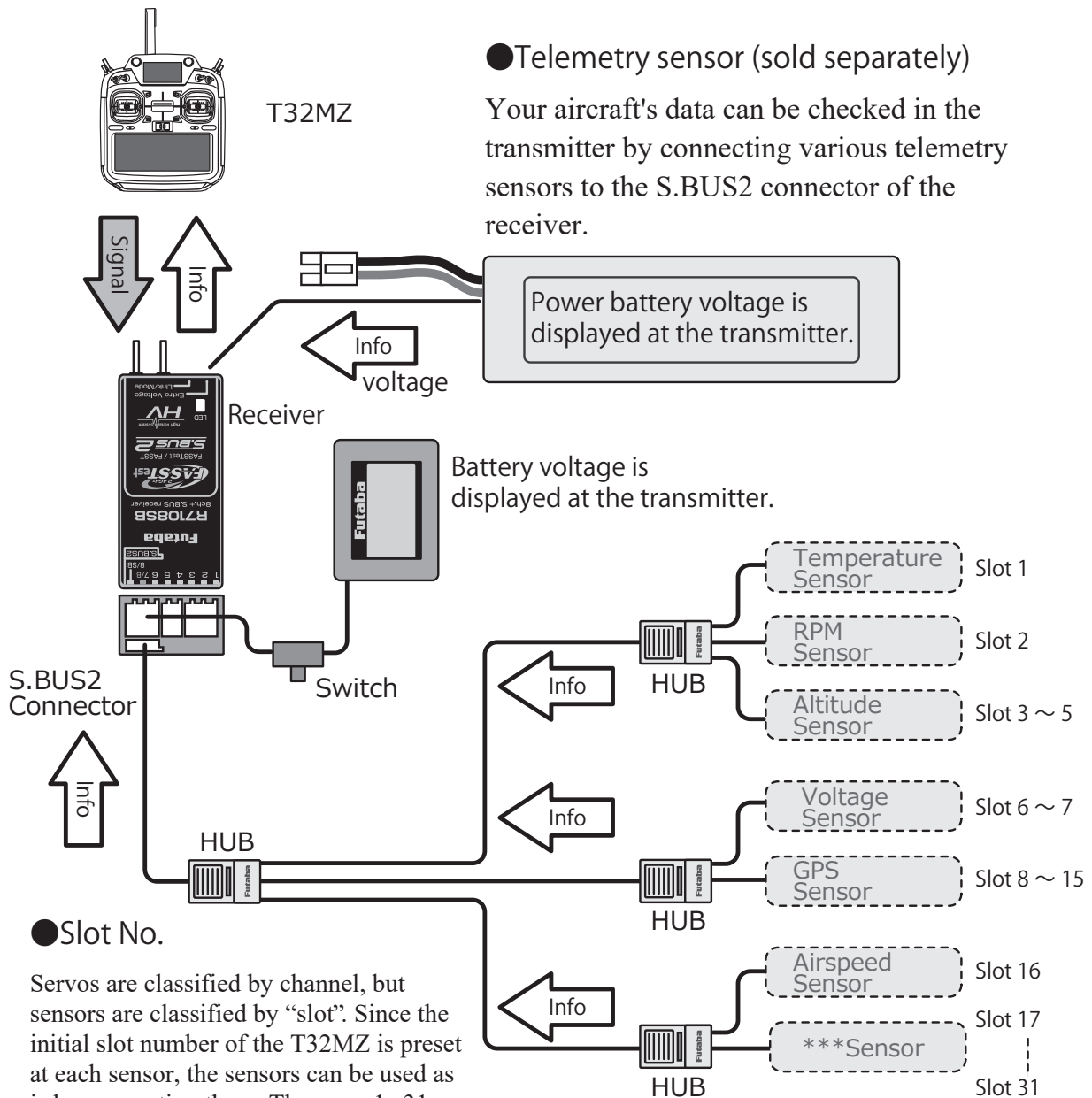

BASIC OPERATION

How to turn ON/OFF the power of the transmitter

Windows® Embedded Compact 7 is installed as a built-in operating system in the T32MZ transmitter. Compared to the conventional system, the T32MZ takes extra time for internal processing when it is turned on/off.

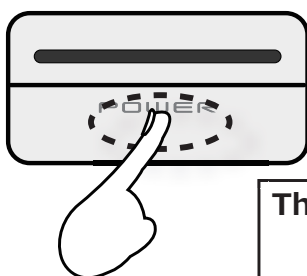

The center switch is pushed.

When turning on the power of the transmitter

1. Place the throttle stick below 1/3 closed.
2. Turn on the power switch.

*After initialization of the transmitter is complete, the LED monitor turns Purple.

*If your throttle stick is not at 1/3 closed or fully closed, a warning will sound. If you move the throttle to 1/3 closed or fully closed, the warning will stop and will become a "Transmit ?" screen.

*If you push the button "NO", then the transmitter will not emit radio waves.

*If you push the button "Yes", then the transmitter will emit radio waves.

*If a battery is removed and it re-connects, please switch on a power supply, after 3 seconds or more pass.

Start-up time;

The time required to initialize the internal circuit of the transmitter varies between the previous time you turned the power off and then restarted the transmitter. There are two "start up" modes for your transmitter, see below:

Cold start;

If you turn on the transmitter more than four hours after you last turned it off, the mode is "Cold start". "Cold start" is normal for the first initial power up of the day. It will take about 30 seconds to be ready for use, as it takes time to initialize the internal circuit of the transmitter.

Hot start;

If you turn on the transmitter less than four hours after you last turned it off, the mode is "Hot start". Since initialization has been partly completed, the transmitter will be ready to use in several seconds.

Since initialization has been partly completed, the transmitter will be ready to use in several seconds. "Hot start" takes place usually at a second flight or later flight in the day.

⚠ WARNING

- ⊘ Once you turn on the power, never shut off the power switch until the power becomes stable (or until the first screen shows up). If you turn off the power switch while the transmitter is going through the initialization process, the data could be damaged.

Note: The start-up time may be a little bit slower when the microSD card is installed compared to when the card is not.

How to stop the transmitter

Turn off the power switch of the transmitter. The internal circuit of the transmitter starts the shut down process including saving the set-up data.

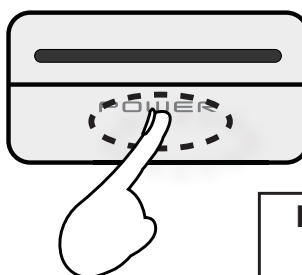

Push and hold the center switch.

- ⊘ Once you turn off the power, never operate the power switch until the power shutdown process is fully completed. If you turn on the power switch again while the transmitter is still in the process of power shutdown, the data could be damaged.

How to reset software

If the screen freezes for some reason and you cannot edit, the transmitter power supply is not fully off even if you turn OFF the power switch. You will need to remove the battery and reinsert it again. In this case, the power restarts in "Cold mode". Even though the screen freezes, all the other functions for radio control operation remain operative.

Home screen

This is the Home screen and descriptions of its menus. Use your finger or included stylus pen to operate the touch screen.

- | | |
|---|--|
| <p>① Timer</p> <p>If one of two timer displays is pushed, you will enter the Timer screen of a Linkage menu.</p> <p>In the button mode of a timer set, it can also be made a start/stop.</p> <p>A push on reset will reset a time.</p> | <p>⑨ User's name</p> <p>Push this area to enter the User's Name Setting screen.</p> |
| <p>② Menu Button</p> <ul style="list-style-type: none"> • System menu • Linkage menu | <p>⑩ Condition</p> <p>The condition name that is currently used is displayed here.</p> <ul style="list-style-type: none"> • Push this area to enter the Condition Select screen. |
| <p>③ System Selection</p> <ul style="list-style-type: none"> • FASSTest18CH • FASSTest12CH • FASST MULTI • FASST 7CH • S-FHSS • T-FHSS | <p>⑪ Battery Indicator</p> <ul style="list-style-type: none"> • When the remaining battery reaches 10%, the alarm will beep. Land your aircraft immediately. |
| <p>④ System timer/Reset</p> <ul style="list-style-type: none"> • This shows the total accumulated time used for the transmitter. This can be reset. <p>(Hour):(Minute):(Second)</p> <p>Push this area to reset the timer.</p> | <p>⑫ Menu Button</p> <ul style="list-style-type: none"> • Model menu |
| <p>⑤ Voltage of Rx/Ext battery</p> <p>Information from the receiver is displayed when using a bidirectional system.</p> <p>FASSTest/T-FHSS Only.</p> | <p>⑬ Model Name</p> <p>The model name that is currently used is displayed here.</p> <ul style="list-style-type: none"> • Push this area to enter the Model Select screen. |
| <p>⑥ Home2</p> <p>A timer and Telemetry data change to Home2 screen by which it was indicated by expansion.</p> | <p>⑭ Clock</p> <p>This shows the today's date and the current time.</p> <ul style="list-style-type: none"> • Push this area for the Date & Time Setting screen. |
| <p>⑦ RF Indicator</p> <p>"ON AIR" or "RF OFF"</p> | |
| <p>⑧ Digital trim (T1 to T6)</p> <p>Push this area to enter the Dial Monitor screen.</p> | |

⚠ WARNING

- ❗ Be sure to confirm the model name before flying your aircraft.
- ❗ Check the remaining battery as often as possible and try to charge the battery regularly. If the battery alarm sounds and its warning symbol is displayed, land your aircraft immediately.

*Please note that the screens in this manual may differ slightly from the actual transmitter.

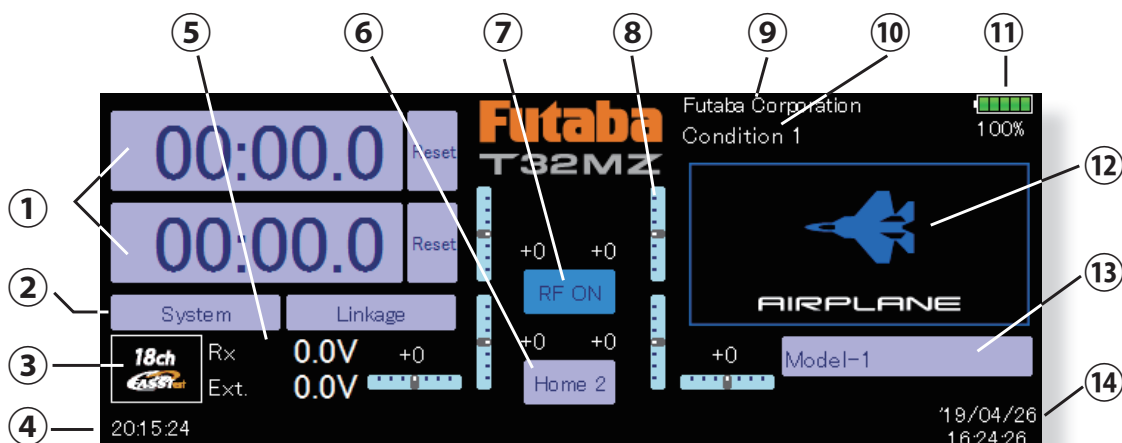

Sub-Display

The sub-display can display timer or telemetry data.

(The sub display is not a touch panel. The setting operation is performed on the main display.)

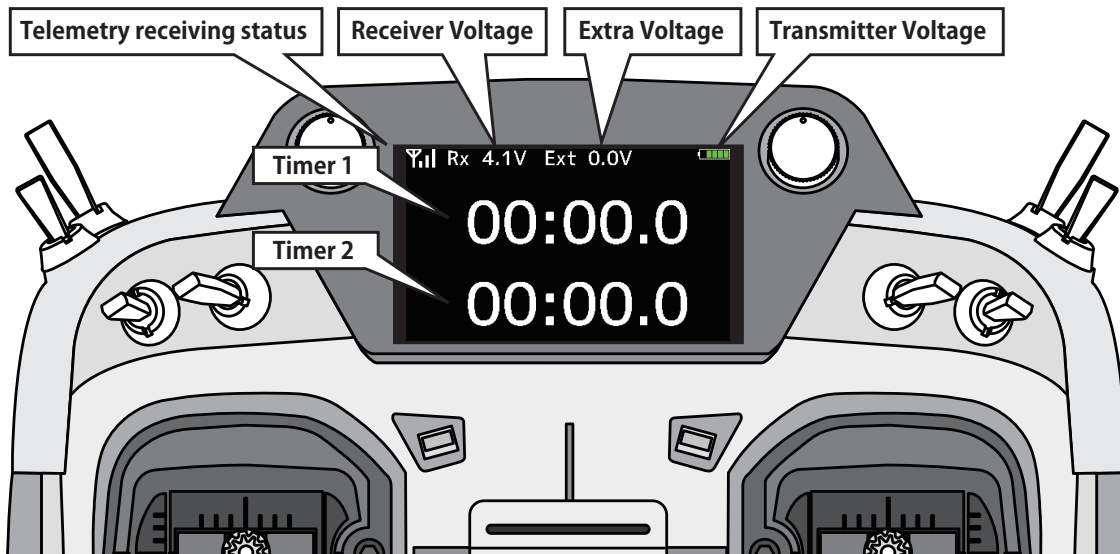

How to display telemetry information

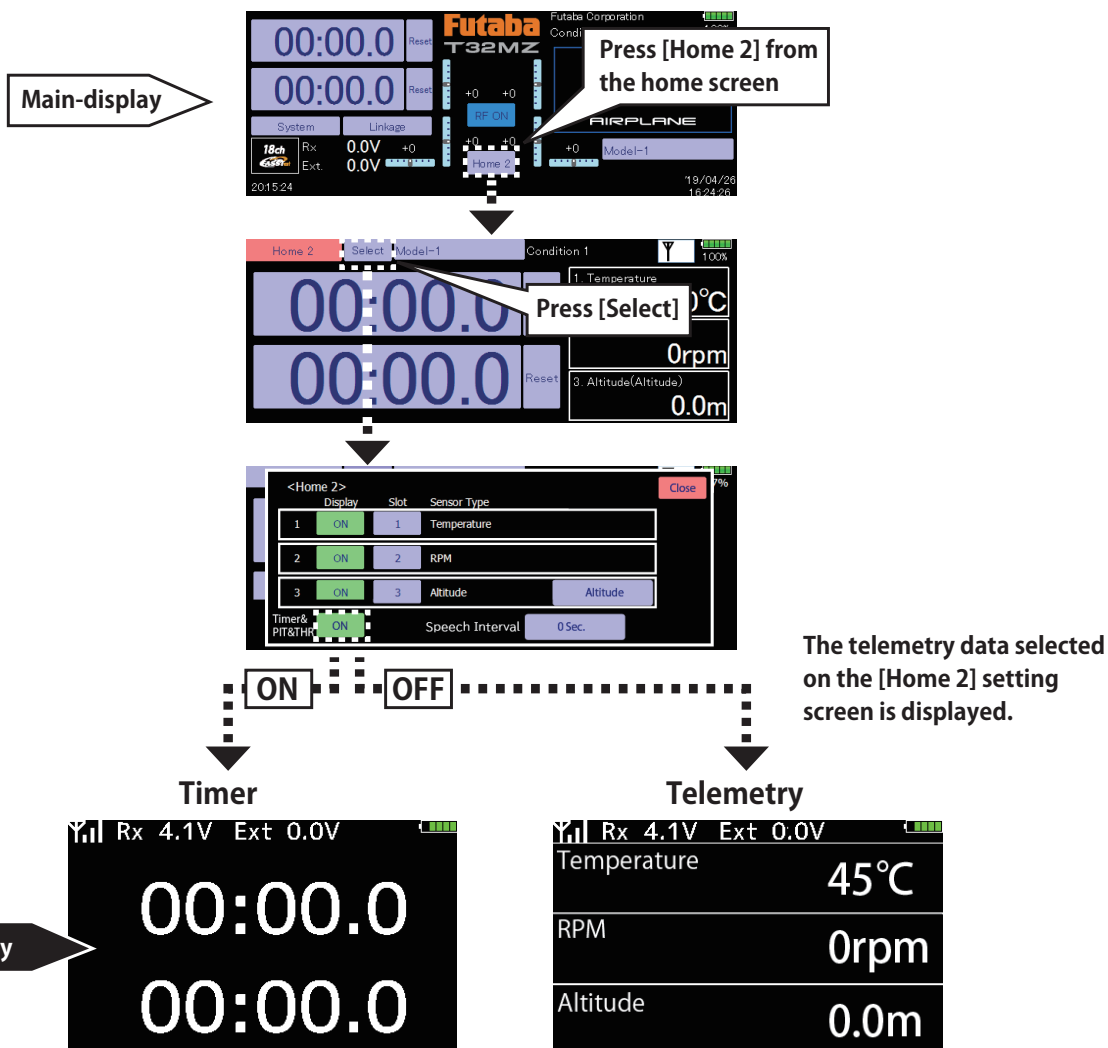

Link procedure (T32MZ ↔ R7108SB)

Each transmitter has an individually assigned, unique ID code. In order to start operation, the receiver must be linked with the ID code of the transmitter to which it is being paired. Once the link is made, the ID code is stored in the receiver and no further linking is necessary unless the receiver is to be used with another transmitter. When you purchase additional R7108SB receivers, this procedure is necessary; otherwise the receiver will not work.

Linking method (T32MZ ↔ R7108SB)

1. Bring the receiver to be linked to within 50 cm of the transmitter.

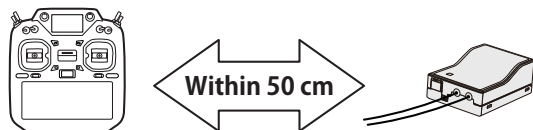

2. Transmitter in link mode.

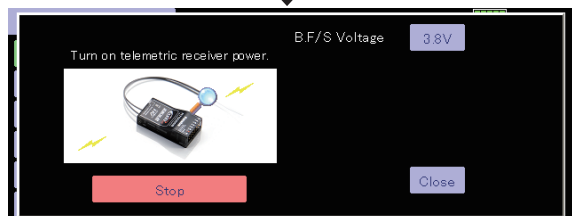
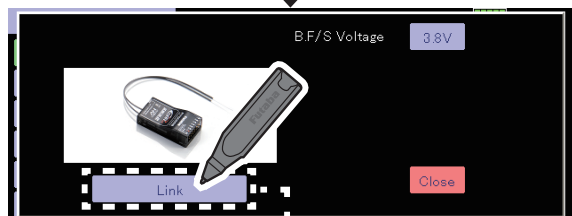
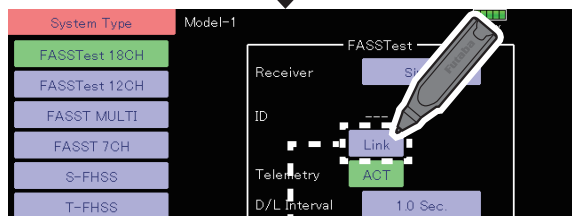
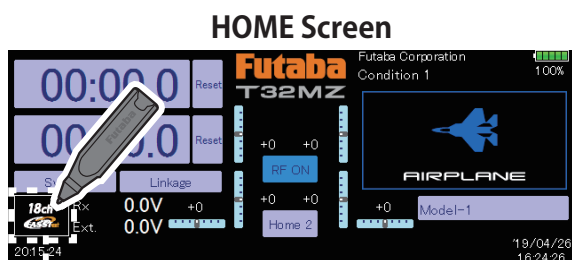

3. The transmitter emits a chime sound and enters the link mode.
4. The receiver power is immediately turned on. About 2 seconds after the power is turned on the receiver enters the linking state. (Receiver linking time is about 1 second).

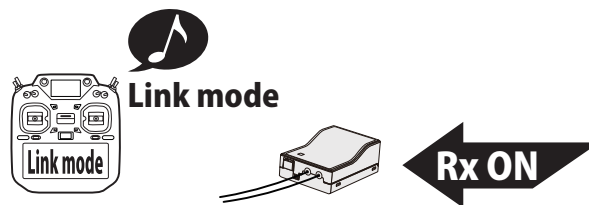

5. If linking is successful, the receiver LED changes from red to green, the link mode ends, and the receiver ID code is displayed.
6. If linking fails, an error message is displayed. Bring the transmitter closer to the receiver and repeat the procedure above from step 2.

- * Do not perform the linking operation when the drive motor is connected or the engine is running.
- * When you use two receivers, please be sure to setup a "primary" and "secondary" in the "dual" mode.
- * Since two sets of receivers cannot be individually recognized without using a "primary" and "secondary" setup, it is impossible to receive telemetry data correctly.
- * You must link one receiver at a time. If both power supplies to the receivers are switched on simultaneously, data is received incorrectly by the transmitter.
- * A telemetry function cannot be used for the 2nd receiver.
- * You cannot link three sets of receivers.
- * Link is required when a system type is changed.
- * Link is required when a new model is made from a model selection.

⚠ WARNING

- ⊘ Do not perform the linking operation when the drive motor is connected and the engine was started.
- Inadvertent rotation of the motor or acceleration of the engine is extremely dangerous.

- ❗ Once the link operation is complete, please check that your receiver can be operated with the linked transmitter.

- ❗ Check operation sufficiently before flying after linking.

- If the same receiver is sending in the vicinity, there is the danger that the transmitter may be linked with that receiver.

⚠ CAUTION

- ❗ Always turn on the transmitter power after linking is complete.

- ❗ When pairing with the transmitter, be sure that a previously linked transmitter is not transmitting

Model ID

FASSTest, T-FHSS

For the sake of safety, this function does not operate the receiver if the model data of the model program settings that does not match the aircraft is used by mistake.

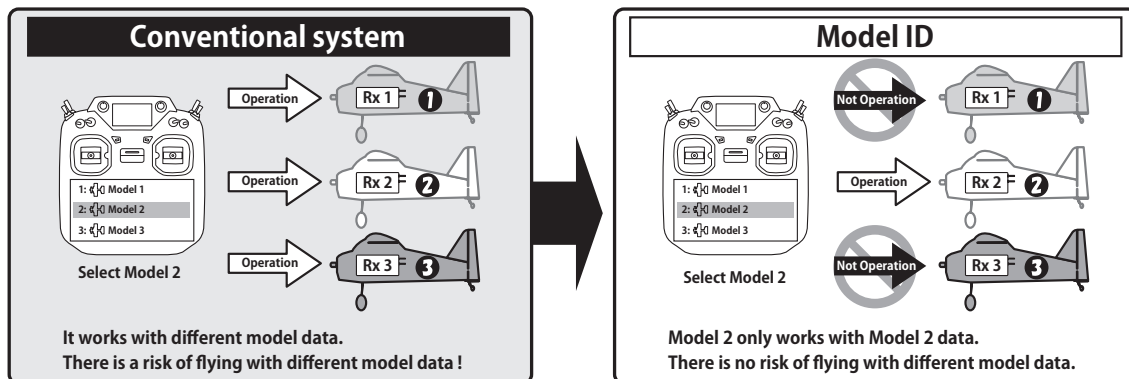

Link is required when a new model is made from a model selection.

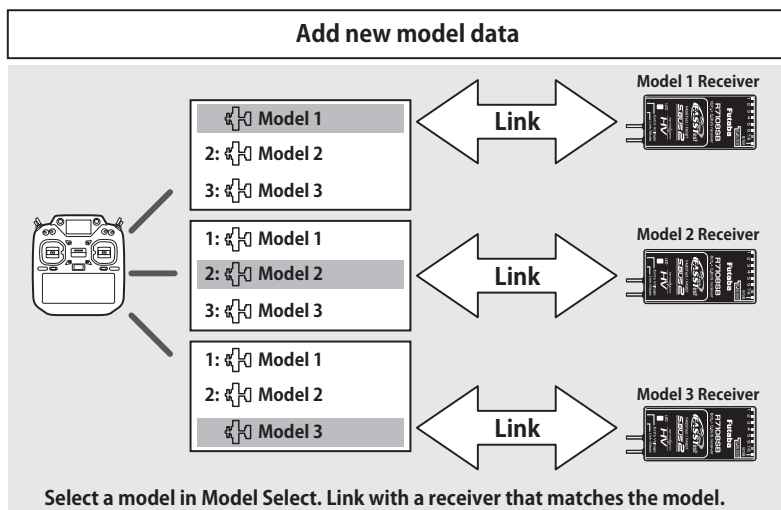

- In the system types (FASSTest, T-FHSS) compatible with the model ID function, a unique ID number (model ID) is set to each model data. Linking with a receiver stores the model ID of the model data in that receiver. The receiver operates only when it receives radio waves transmitted using model data that matches the stored model ID. As a result, the receiver does not operate even if model data of an unintended setting is used by mistake, so it is possible to prevent a malfunction due to a model selection mistake.
- If you want to use different model data from the model data that you have been using, link again.
- Model ID feature is enabled only if the system type is FASSTest or T-FHSS. Please note that model ID function can not be used on other systems.
- For safety reasons, model ID function can not be disabled.
- Model data that can be stored in internal memory is up to 250 models.
- Model ID is automatically set when copying or adding model data.

When using R3004SB

- When using the **R3004SB**, set "Receiver" in the system type screen T-FHSS mode setting to **[R3004SB]**.
When using other T-FHSS compatible receivers, set "Receiver" to [Normal].

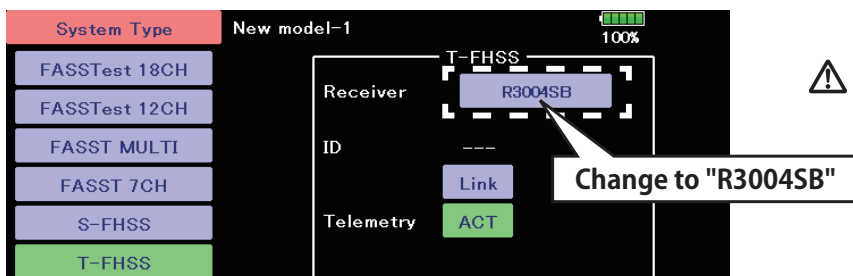

How to change the number of value

When the button indicating the value of each function is pressed, the value setting button appears at the right end of the screen.

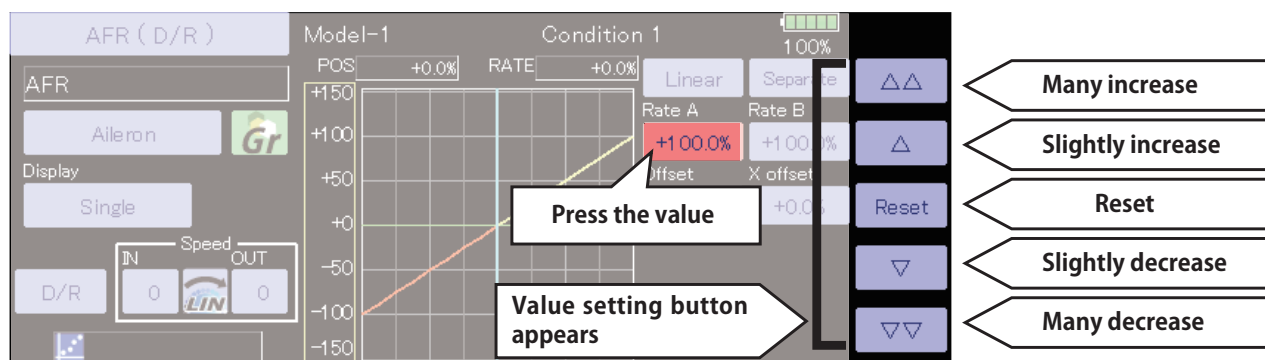

How to activate the function

When the INH button is pressed, the function turns ON or OFF and the function is enabled.

INH indicates that the function is disabled.

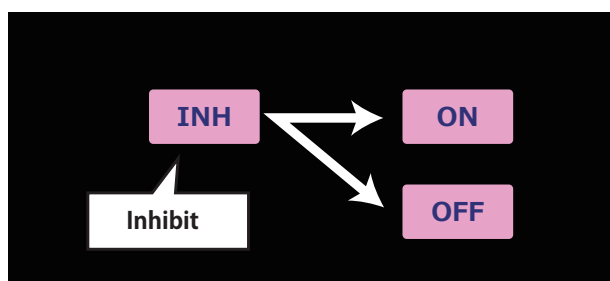

How to return to home screen or go back one step

When you press the HOME/EXIT button from each screen (other than the home screen), you will return to the previous screen.

You can return to the HOME screen by push and hold the HOME/EXIT button.

Push : Return to the previous screen
Push and Hold : Return to the HOME screen

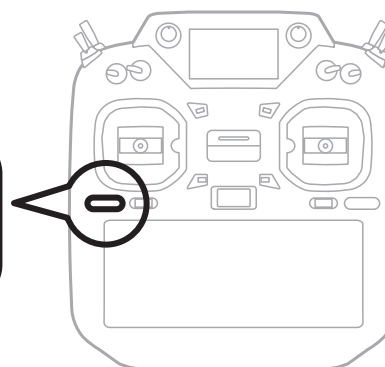

Page of each setting screen

It is a notation when there are several pages of functions.

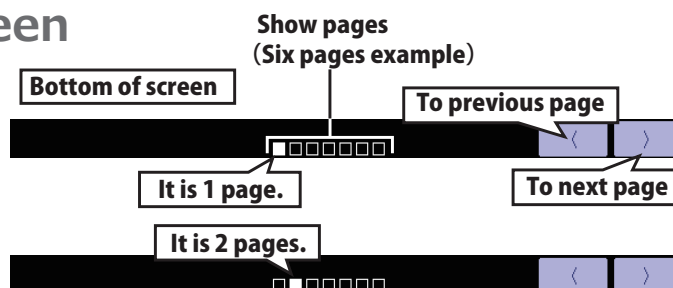

Switch selection

Select the switch to operate the function.

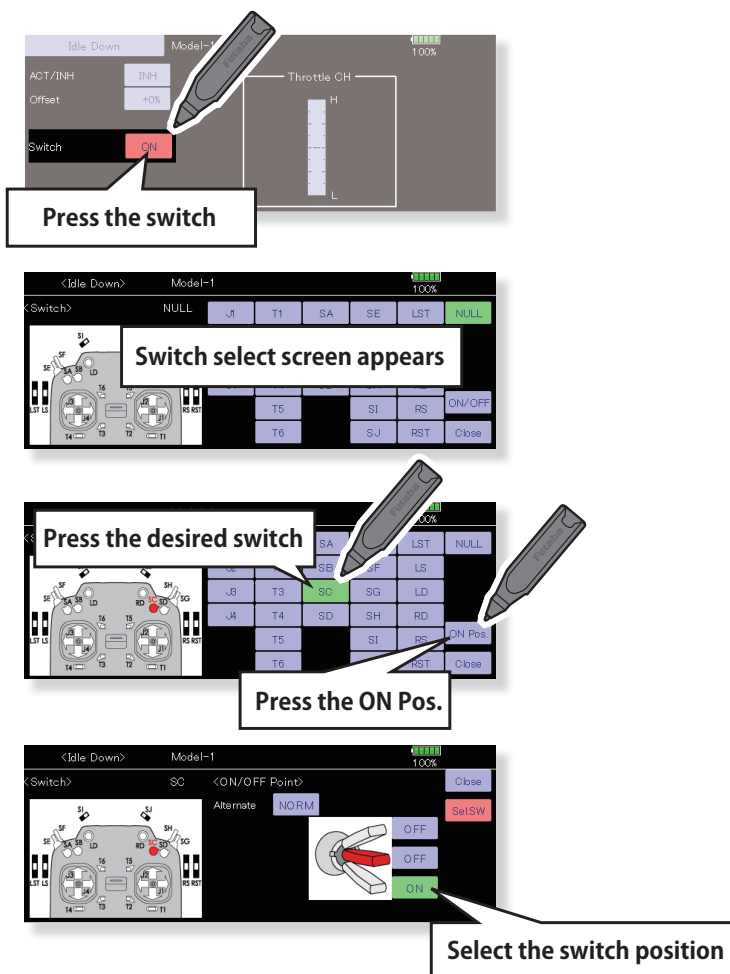

Display of operation status

A message is displayed for 5 seconds when the switch (stick, knob, slide lever) that operates the function is operated.

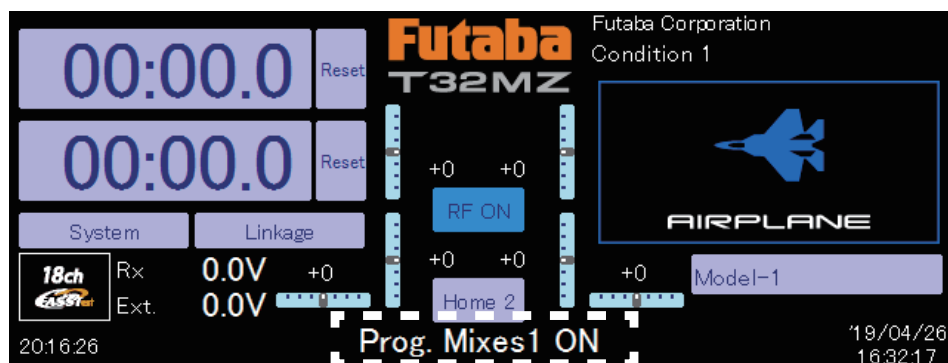

A message is displayed when the function is turned ON/OFF. It is displayed for 5 seconds from the time of operation.

Home2 screen

If [Home2] is pushed, it will become the display to which the timer and the telemetry data were expanded.

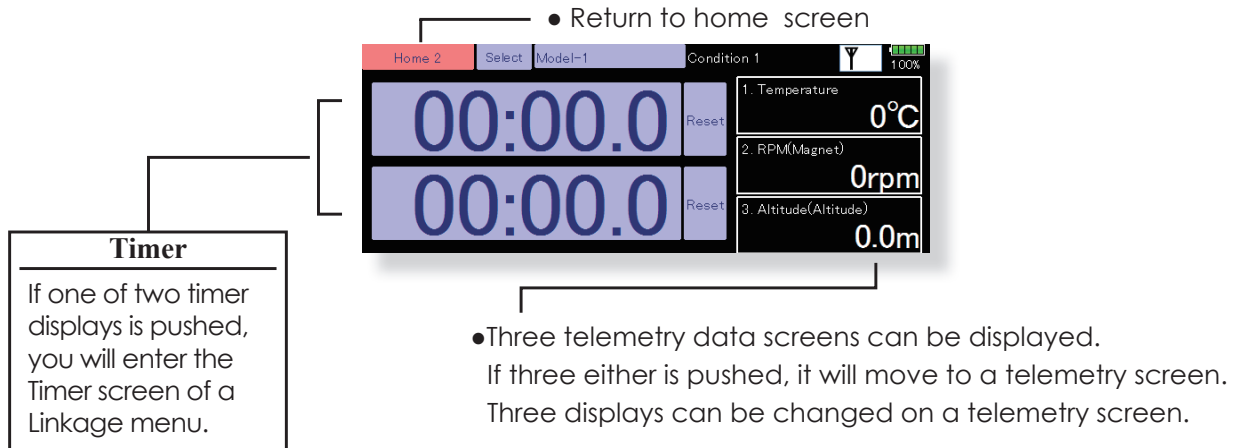

Panel lock

Temporarily activating this function makes it impossible to change data by mistakenly touching keys during flight.

Please perform a touch-panel lock for safety. Touch screen in [System Menu] → [Display] other than the following has an automatic setup.

Start-up lock: It becomes a panel lock at the time of the power supply ON.

Automatic lock: It synchronizes with Backlight decrease time and becomes a panel lock.

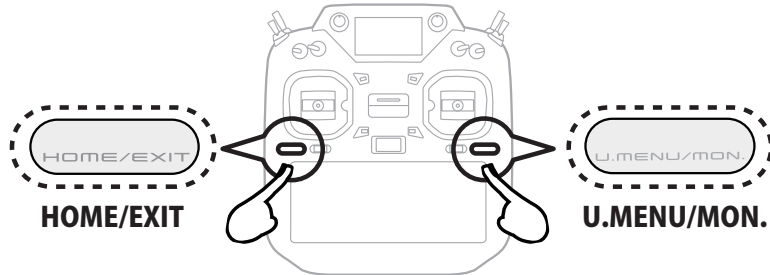

Lock by simultaneous pressing

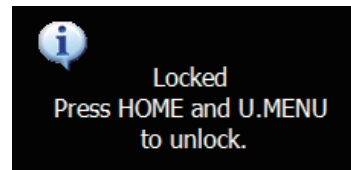

- If the touch panel is touched while locked, this display appears and touch panel operation can not be performed.

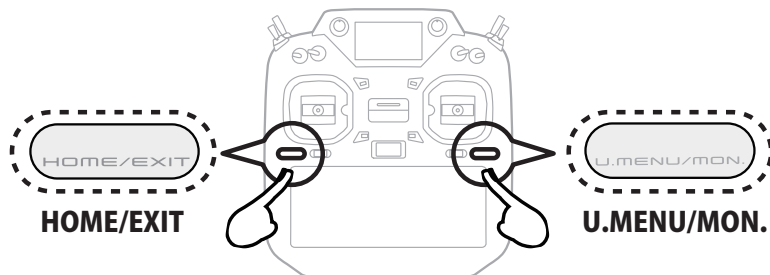

Unlock by simultaneous pressing

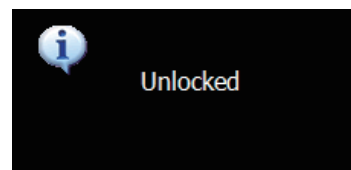

⚠ DANGER

- ❗ The T32MZ touch screen is very sensitive. To avoid accidentally activating it during a flight, it is suggested that it be locked. Due to the touch screen's sensitivity, allowing it to be touched during flight by a neck strap hook, servo extension, or even your hand could be dangerous. Please use the touch panel lock for added safety during flight.

Registration of the user's name

T32MZ transmitter can register user's name.

How to register user's name

1. Turn on the power of the transmitter.
2. Push the area of the user's name shown on the home screen or the "user's name" in the system menu. Then the User's Name Set screen will pop up.

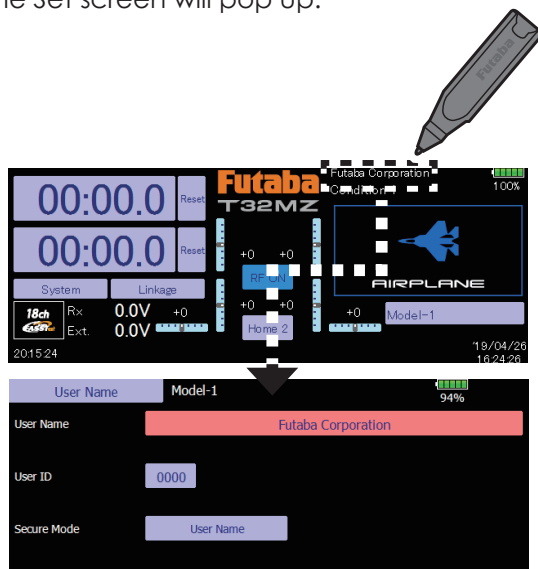

3. Push the user's name. Then the keyboard will pop up. You can use up to 32 characters as a user's name. Use the keyboard on the screen to enter user's name.



4. Push "Return" key to return to the previous screen after entering the user's name.

(If you want to protect the user's name)

If you don't want anybody else to change your user's name, set your ID in the following way.

*Please be aware that you will not be able to change user's name if you forget your password.

1. Make sure that the security mode is "User's name", and then push the User ID button.
2. Enter your password, using keyboard on the screen. You will need to enter your password for changing the user's name, the next time you turn on the power.

*Even if you enter the same character, your password will be identified differently depending on whether you are using "Transform" mode or "Direct" mode for inputting.

MODEL BASIC SETTING PROCEDURE

Airplane/glider basic setting procedure

1. Model addition and call

Default settings assign one model to the T32MZ transmitter. To add new models or select previously setup models, use the Model Select function in the Linkage Menu.

When a new model is added, relink with the receiver used in that model.

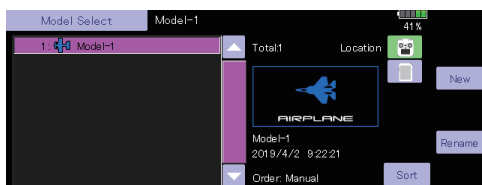

This is convenient when calling a model after its name has been registered.

The currently selected model name is displayed at the top of the screen. Before flying and before changing any settings, always confirm the model name.

When a new model is added, the model type select screen/system type/receiver link automatically appears. Please be aware that the transmitter will stop transmitting when you change the model.

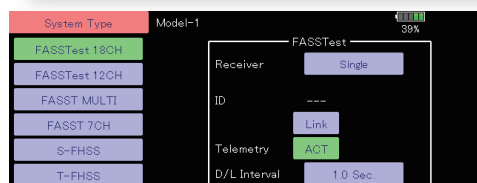
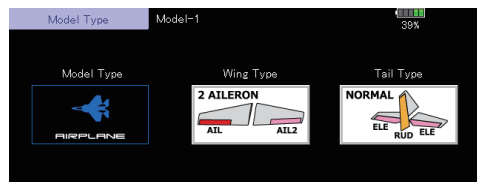

2. Model type selection

Select the model type matched to the fuselage with the Model Type select function of the Linkage Menu. For an airplane, select the model type from among the 3 types: airplane, glider, and motor glider. When the wing type select screen is displayed and the wing type is selected when selecting the model type, the tail type select screen is displayed. Select the tail type matched to the fuselage.

There are 13 wing types and 3 tail types for airplane, glider, and motor glider.

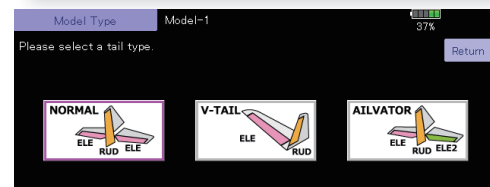
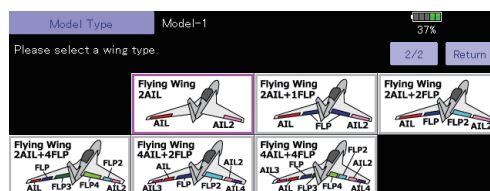
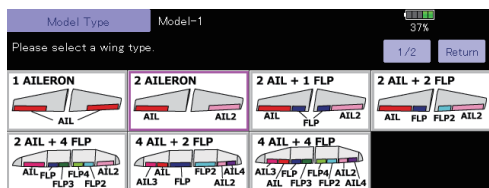

3. Airplane linkage

Link the ailerons, elevators, throttle, rudder, etc. in accordance with the model's instruction manual. For a description of the connection method, see the receiver and servo connection.

Note: The channel assignment of the T32MZ is different from that of our existing systems. Note that even for the same "airplane model", when the wing type and tail type are different, the channel assignment has been optimized and may be different. (The channel assigned to each function can be checked in the Function menu of the Linkage Menu.)

CH	Function	Control	Trim	CH	Function	Control	Trim
1	Aileron	J1	T1	7	Auxiliary5	NULL	NULL
2	Elevator	J3	T3	8	Auxiliary4	NULL	NULL
3	Throttle	J2	T2	9	Auxiliary3	NULL	NULL
4	Rudder	J4	T4	10	Auxiliary2	NULL	NULL
5	Gear	SG	NULL	11	Auxiliary1	NULL	NULL
6	Aileron2	NULL	NULL	12	Auxiliary1	NULL	NULL

- When the direction of the linkage is reversed, adjust the direction with the Servo Reverse function in the Linkage Menu.

CH	Function	Setting	CH	Function	Setting	CH	Function	Setting
1	Aileron	NORM	7	Auxiliary5	NORM	13	Auxiliary1	NORM
2	Elevator	NORM	8	Auxiliary4	NORM	14	Auxiliary1	NORM
3	Throttle	NORM	9	Auxiliary3	NORM	15	Auxiliary1	NORM
4	Rudder	NORM	10	Auxiliary2	NORM	16	Auxiliary1	NORM
5	Gear	NORM	11	Auxiliary1	NORM			
6	Air Brake	NORM	12	Auxiliary1	NORM		DG1	NORM
							DG2	NORM

- Connect the throttle linkage so the carburetor is open at full trim and full open so that the throttle can be cut.
- Adjust the neutral position and rudder angle with the linkage, and fine tune them with the Sub Trim and End Point functions (rudder angle adjustment). To protect the linkage, a limit position can also be set with the End Point function. The End Point function can adjust the amount of up/down and left/right movement, limit, and servo speed of each channel.

AIRPLANE

GLIDER

4. Throttle cut setting (In case of engine model)

Throttle cut can be performed with one touch by a switch without changing the throttle trim position.

Set throttle cut with the Throttle Cut function of the Linkage Menu. After activating the throttle cut function and selecting the switch, adjust the throttle position so that the carburetor becomes full close. For safety, the throttle cut function operates the throttle stick in the slow position.

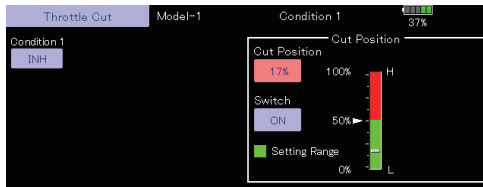

5. Idle down setting (In case of engine model)

The idling speed can be lowered with one touch by a switch without changing the throttle trim position. Perform this setting with the Idle Down function of the Linkage Menu. After activating the Idle Down function and selecting the switch, adjust the idle down speed. For safety, the idle down function acts only when the throttle stick is in the slow position.

*While the Throttle Cut function is in operation, the Idle Down function does not work.

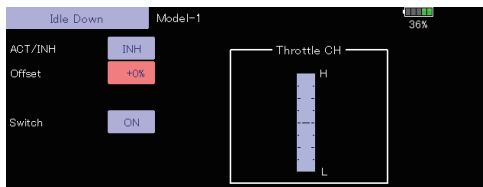

6. AFR (D/R)

AFR function is used to adjust the throw and operation curve of the stick, lever, and switch functions for each flight condition. This is normally used after End Point (ATV) has defined the maximum throw directions (End Point acts on all flight condition settings). When mixing is applied from one channel to another channel, both channels can be adjusted at the same time by adjusting the operation rate through the AFR function.

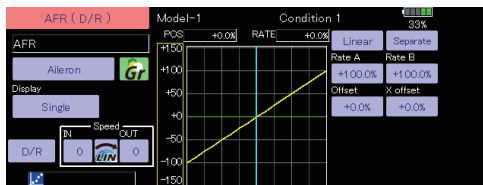

7. Airbrake

This function is used when an air brake is necessary when taking off or diving, etc.

The preset elevators and flaps (camber flap, brake flap) offset amount can be activated by a switch.

The offset amount of the aileron, elevator, and flap servos can be adjusted as needed. Also the speed of the aileron, elevator, and flap servos can be adjusted. (IN side/OUT side) A delay can be set for each condition, and a cut switch which will turn OFF the delay can be chosen. Trim amounts can be fine-tuned by setting a VR. You can also set the auto mode, which will link Airbrake to a stick, switch, or dial. A separate stick switch or dial can also be set as the ON/OFF switch.

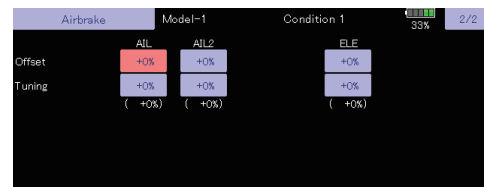

8. Addition of flight conditions

The transmitter can install up to eight flight conditions per model. You can assign all switches including sticks, switches, trim levers and trim switches as flight-condition selection switches. You can also add delayed mixing to these functions in order to avoid sudden changes. Moreover, you can set priority order for flight conditions when you set more than one condition. In addition, you can copy conditions and/or change names of conditions. This command may also be used to define what switches and/or controls are used to activate each flight condition.

The Condition Select function automatically allocates the condition 1 for each model type. Condition 1 is the default condition, also referred to as normal, and is the only one active when a new model type is defined. This condition is always ON, and remains ON until other conditions are activated by switches.

The Condition Delay can be programmed for each channel. The Condition Delay is used to change the servo throw smoothly when switching conditions.



*When a new condition is added, "Condition1" data is automatically copied.

*Select the condition switch and set the new condition data with the switch in the ON position. However, if the group mode (Gr.) was selected in advance, the same data will be input to all new conditions. Select the single mode (Sngl) and adjust the condition you want to change.

Helicopter basic setting procedure

1. Model addition and call

Default settings assign one model to the T32MZ transmitter. To add new models or select previously setup models, use the Model Select function in the Linkage Menu.

When a new model is added, relink with the receiver used in that model.

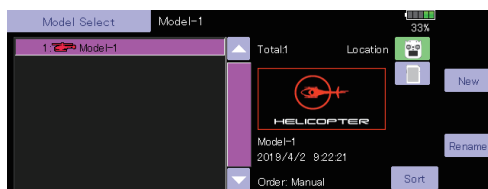

This is convenient when calling a model after registering the model names in advance.

The currently selected model is displayed at the top of the screen. Before flying and before changing any settings, always confirm the model name.

Please be aware that the transmitter will stop transmitting when you change the model.

When a new model is added, the model type select screen/system mode/receiver link automatically appears. Please be aware that the transmitter will stop transmitting when you change the model..

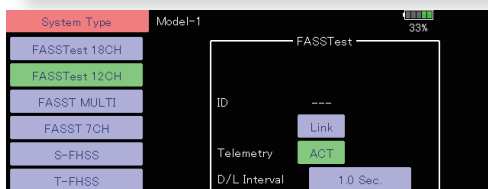
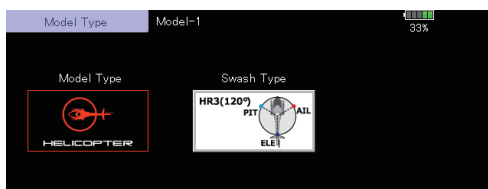

2. Model type and swash type selection

When a separate model type is already selected, select helicopter with the Model Type function of the Linkage Menu, and then select the swash type matched to the helicopter.

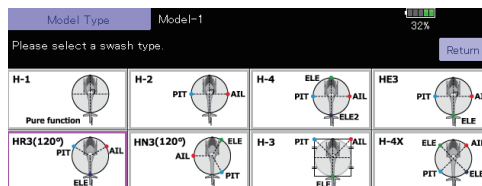
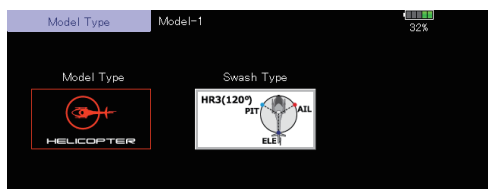

3. Flight condition addition

The transmitter can install up to eight flight conditions per model. You can assign all switches including sticks, switches, trim levers and trim switches as flight-condition selection switches. You can also add delayed mixing to these functions in order to avoid sudden changes. Moreover, you can set priority order for flight conditions when you set more than one condition. In addition, you can copy conditions and/or change names of conditions. This command may also be used to define what switches and/or controls are used to activate each flight condition.

The Condition Select function automatically allocates the default Condition 0 (Normal) for each model type. Condition 0 (Normal) is the only one active when a new model type is defined. This condition is always ON, and remains ON until other conditions are activated by switches.

The Condition Delay can be programmed for each channel. The Condition Delay is used to change the servo throw smoothly when switching conditions.



(General flight condition setting example)

- Normal: (Use initial setting conditions/operate when switch OFF)
Use from engine starting to hovering.
- Idle up 1: (Switch setting example: Operate at SW-E center)
Use in stall turn, loop, and other maneuvers.
- Idle up 2: (Switch setting example: Operate at SW-E forward side)
Use in rolls.
- Throttle hold: (Switch setting example: Operate at SW-G forward side)
Use in auto rotation.

The priority is throttle hold/idle up 2/idle up 1/normal. Throttle hold has the highest priority. Add other conditions, as required.

4. Helicopter linkage

Connect the throttle rudder, ailerons, elevators, pitch, and other rudder linkages in accordance with the kit instruction manual. For a description of the connection method, see "Receiver and servos connection".

*The channel assignment of the T32MZ is different from that of our existing systems. (The channel assigned to each function can be checked at the function menu of the Linkage Menu.)

CH	Function	Control	Trim	CH	Function	Control	Trim
1	Aileron	J1	T1	7	Governor	NULL	NULL
2	Elevator	J3	T3	8	Governor2	NULL	NULL
3	Throttle	J2	T2	9	Gyro2(AIL)	NULL	NULL
4	Rudder	J4	T4	10	Gyro3(ELE)	NULL	NULL
5	Pitch	J2	NULL	11	Needle	LST	NULL
6	Gyro(RUD)	NULL	NULL	12	Auxiliary5	NULL	NULL

- When the direction of the linkage is reversed, use the Reverse function of the Linkage Menu. Also use the swash AFR function in any swash set up other than the H-1 mode.

CH	Function	Setting	CH	Function	Setting	CH	Function	Setting
1	Aileron	NORM	7	Governor	NORM	13	Auxiliary4	NORM
2	Elevator	NORM	8	Governor2	NORM	14	Auxiliary5	NORM
3	Throttle	NORM	9	Gyro2(AIL)	NORM	15	Auxiliary2	NORM
4	Rudder	NORM	10	Gyro3(ELE)	NORM	16	Auxiliary1	NORM
5	Pitch	NORM	11	Needle	NORM	DG1	NORM	
6	Gyro(RUD)	NORM	12	Auxiliary6	NORM	DG2	NORM	

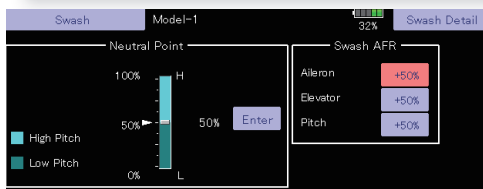

- Adjust the direction of operation of the gyro. (Gyro side function)
- Connect the throttle linkage so it is fully closed with the trim setting all the way down.
- Adjust the neutral position and rudder angle at the linkage side and fine tune with the Sub-Trim function and End Point function (rudder angle adjustment). To protect the linkage, a limit position can also be set with the End Point function.

CH1	CH2	CH3	CH4	CH5	CH6	CH7	CH8	CH9	CH10	CH11	CH12	CH13	CH14	CH15	CH16
AIL	ELE	THR	RUD	PIT	GOV	GOV2	GYR2	GYR3	NDL	AUX5	AUX4	AUX3	AUX2	AUX1	

CH	Function	Limit	Travel	Travel	Limit	Speed
1	Aileron	135%	100%	100%	135%	0
2	Elevator	135%	100%	100%	135%	0
3	Throttle	135%	100%	100%	135%	0
4	Rudder	135%	100%	100%	135%	0
5	Pitch	135%	100%	100%	135%	0
6	Gyro(RUD)	135%	100%	100%	135%	0

- Swash plate correction (Except H-1 mode)
Operation of the swash plate near the hovering point can be corrected by swash AFR function correction mixing. Use this when pitch, aileron, and elevator operation causes the swash plate to deviate from the normal direction.

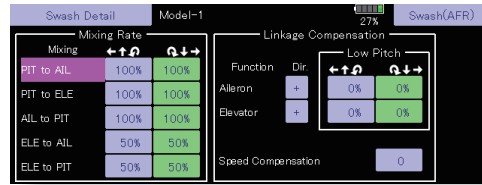

(Call the Swash→Swash details screen.)
Pitch slow side and high side linkage correction is also possible. Adjust so that pitch operation causes the swash plate to move up and down in the horizontal state.

5. Throttle curve setting

This function adjusts the pitch operation curve in relation to the movement of the throttle stick for each condition.

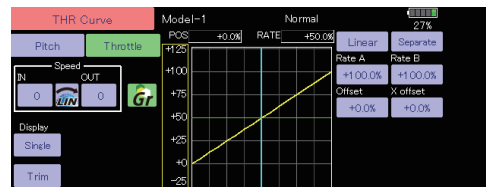

(17 points curve)

The pitch curve can be freely selected from linear operation curve to smooth curve, and adjusted to match the curve you want by means of the T32MZ's powerful Curve Edit Function (Six types of curves can be selected). Up to 17 points can be set for linear or curve types. However, when using the 3 points or 5 points specified to create a curve, a simple and smooth curve can be created by selecting the curve type and reducing the number of input points to 3 or 5, and then entering the specified value at the corresponding points that you created.

<Setting example>

Call the throttle curve of each condition with the condition select switch.

- Normal curve adjustment**
Normal curve uses Normal (Linear) type and creates a basic pitch curve centered near hovering. This curve is adjusted together with the Throttle Curve (Normal) so that the engine speed is constant and up/down control is easiest.
- Idle up curve adjustment**
The high side pitch curve sets the maximum pitch regardless of the engine load. The low side pitch curve creates a curve matched for aerobatics (loop, roll, 3D, etc.).
Note: When the curve type is changed, the data is reset.
- Throttle hold curve adjustment**
The throttle hold curve is used when performing auto rotation dives.

Confirm that the rate of the slowest position (0%) of the stick is 0% (initial setting).
Be sure that when set to high side 100%, the curve of any condition does not exceed 100%.

Example of pitch curve setting:

1. Call the pitch curve of each condition with the condition select switch.
 - *Pitch curve graph display can be switched to pitch angle direct reading display.
- A. Pitch curve (Normal)
 - Make the pitch at hovering approximately $+5^{\circ}\sim 6^{\circ}$. Set the pitch at hovering with the stick position at the 50% point as the standard.
 - *Stability at hovering may be connected to the throttle curve. Adjustment is easy by using the hovering throttle function and hovering pitch function together.
- B. Pitch curve (Idle up 1)
 - The idle up 1 pitch curve function creates a curve matched to airborne flight. Set to $-7^{\circ}\sim +12^{\circ}$ as standard.
- C. Pitch curve (Idle up 2)
 - The high side pitch setting is less than idle up 1. The standard is $+8^{\circ}$.
- D. Pitch curve (Hold)
 - At auto rotation, use the maximum pitch at both the high and low sides.
[Pitch angle setting example]
Throttle hold: $-7^{\circ}\sim +12^{\circ}$

This function sets the servo operation position at throttle hold. (Throttle cut and idle positions)

- Other settings
When you want to link operation with stick manipulation, the Auto mode can be set. When you want to adjust the servo speed, adjust [Speed].

7. Pitch to RUD mixing setting

Use this function when you want to suppress the torque generated by the changes in the pitch and speed of the main rotor during pitch operation. Adjust it so that the nose does not swing in the rudder direction. However, when using a heading hold gyro like those shown below, do not use Pitch to RUD mixing.

Note: When using a Futaba GY series gyro, or other heading hold gyro, this Pitch to RUD mixing should not be used. The reaction torque is corrected at the gyro side. When operating the gyro in the AVCS mode, the mixed signal will cause neutral deviation symptoms and the gyro will not operate normally.

Call the Pitch to RUD mixing function from the Model Menu, and set the curve for each condition. (At initial setting, this function is in the "INH" state. To use it, set it to the "ON" state.)

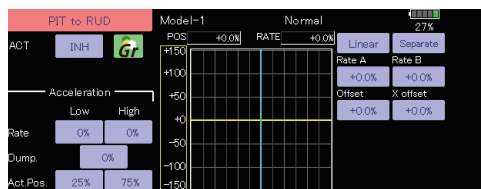

6. Throttle hold setting

Call the Throttle Hold function from the Model Menu and switch to the throttle hold condition with the condition select switch.

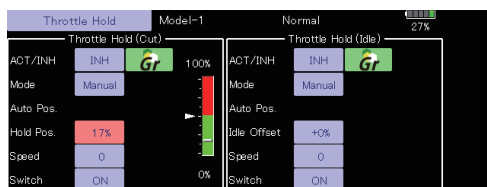

Note: At initial setting, the setting mode is the group mode. Since this function is not used at other conditions, switch to the single mode before setting.

- Setting to the state which activates the function
The throttle hold function allows setting for throttle cut and switching of the function fixed at the idle position by switch for training. Either one or both functions can be performed.
- Hold position setting

(17 points curve)

Curve setting of up to 17 points is possible. However, in the following setting example, a simple curve can be adjusted by using the [Linear] curve type.

Note: At initial setting, the setting mode is the group mode. In this mode, the same contents are set at in all conditions. When you want to set the selected condition only, switch to the single mode.

<Setting example>

Call the mixing curve of each condition with the condition select switch.

1. A curve setting example is shown below.

A. Pitch to RUD mixing curve (Normal)

Use the hovering system and set this curve to match take off and landing and vertical climb at a constant speed.

*For this curve, use the initial setting [Linear] curve type and adjust the left and right rates in the [Separate] mode.

B. Pitch to RUD mixing (Idle up 1)

Use this curve in stall turn, loop, and adjust it so the fuselage is facing straight ahead when heading into the wind.

*For this curve, [Linear] curve type can be used and the entire curve can be lowered with the [Offset] button.

C. Pitch to RUD mixing (Hold)

This function is set so that the fuselage is facing straight ahead during straight line auto rotation. The pitch of the tail rotor becomes nearly 0°.

*For this curve, [Linear] curve type can be used and the entire curve can be lowered with the [Offset] button.

•Other settings

The mixing rise characteristic of pitch operation can be adjusted. An acceleration (ACLR) function, which temporarily increases and decreases the mixing amount, can be set.

8. Swash Mix corrects aileron, elevator and pitch interaction

The swash mix function is used to correct the swash plate in the aileron (roll) direction and elevator (cyclic pitch) corresponding to each operation of each condition.



9. Throttle mixing setting

RPM loss caused by swash operation of aileron or elevator can be corrected with the Throttle Mix function in the Model Menu. The effects of clockwise and counterclockwise torque applied when pirouetting can also be corrected.

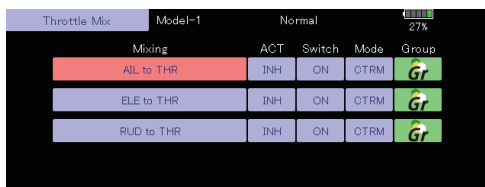

10. Gyro sensitivity and mode switching

The gyro sensitivity and mode switching function is dedicated to gyro mixing for each model used, and can be set for each condition.

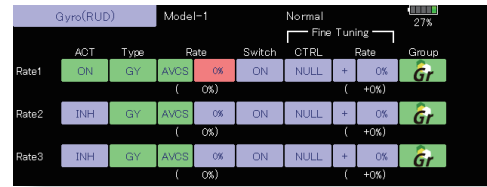

- Normal condition (hovering): Gyro sensitivity maximum
- Idle up 1/Idle up 2/Throttle hold: Gyro sensitivity minimum
- However, at auto rotation of a tail-driven helicopter, this function may not have any affect at high gyro sensitivity.

11. Throttle cut setting

Throttle cut provides an easy way to stop the engine, by flipping a switch with the throttle stick at idle. The action is not functional at high throttle to avoid accidental dead sticks. The switch's location and direction must be chosen, as it defaults to NULL.



*With throttle stick at idle, adjust the cut position until the engine consistently shuts off, but throttle linkage is not binding. When finished, touch the "Throttle Cut" button to exit.

12. Other special mixings

- Pitch to Needle mixing
This mixing is used with engines with a construction which allows needle control during flight (fuel-air mixture adjustment). A needle curve can be set. The needle servo rise characteristics at throttle stick acceleration/deceleration operation can be adjusted. (Acceleration function)
- Fuel mixture function
This mixing is used in needle adjustment of engines which use a fuel mixture control carburetor.
- Governor mixing
This mixing is dedicated governor mixing when a governor is used. Up to 3 rates (speeds) can be switched for each condition.

Servos connection by model type

The T32MZ transmitter channels are automatically assigned for optimal combination according to the type selected with the Model Type function of the Linkage Menu. The channel assignment (initial setting) for each model type is shown below. Connect the receiver and servos to match the type used.

*The set channels can be checked at the Function screen of the Linkage Menu. The channel assignments can also be changed. For more information, read the description of the Function menu.

Airplane/glider/motor glider

•Airplane and V tail

AIRPLANE

GLIDER

RX CH	1AIL			2AIL			2AIL+1FLAP			2AIL+2FLAP		
	Airplane	Glider		Airplane	Glider		Airplane	Glider		Airplane	Glider	
		EP			EP			EP			EP	
1	Aileron	Aileron	Aileron	Aileron	Aileron	Aileron	Aileron	Aileron	Aileron	Aileron	Aileron	Aileron
2	Elevator	Elevator	Elevator	Elevator	Elevator	Elevator	Elevator	Elevator	Elevator	Elevator	Elevator	Elevator
3	Throttle	Motor	AUX7	Throttle	Motor	AUX7	Throttle	Motor	AUX7	Throttle	Motor	AUX7
4	Rudder	Rudder	Rudder	Rudder	Rudder	Rudder	Rudder	Rudder	Rudder	Rudder	Rudder	Rudder
5	Gear	AUX6	AUX6	Gear	AUX6	AUX6	Gear	AUX6	AUX6	Aileron2	Aileron2	Aileron2
6	Airbrake	Airbrake	Airbrake	Aileron2	Aileron2	Aileron2	Aileron2	Aileron2	Aileron2	Flap	Flap	Flap
7	AUX5	AUX5	AUX5	AUX5	AUX5	AUX5	Flap	Flap	Flap	Flap2	Flap2	Flap2
8	AUX4	AUX4	AUX4	AUX4	AUX4	AUX4	AUX5	AUX5	AUX5	Gear	AUX6	AUX6
9	AUX3	AUX3	AUX3	AUX3	AUX3	AUX3	AUX4	AUX4	AUX4	AUX5	AUX5	AUX5
10	AUX2	AUX2	AUX2	AUX2	AUX2	AUX2	AUX3	AUX3	AUX3	AUX4	AUX4	AUX4
11	AUX1	AUX1	AUX1	AUX1	AUX1	AUX1	AUX2	AUX2	AUX2	AUX3	AUX3	AUX3
12	AUX1	AUX1	AUX1	AUX1	AUX1	AUX1	AUX1	AUX1	AUX1	AUX2	AUX2	AUX2
13	AUX1	AUX1	AUX1	AUX1	AUX1	AUX1	AUX1	AUX1	AUX1	AUX1	AUX1	AUX1
14	AUX1	AUX1	AUX1	AUX1	AUX1	AUX1	AUX1	AUX1	AUX1	AUX1	AUX1	AUX1
15	AUX1	AUX1	AUX1	AUX1	Butterfly	Butterfly	AUX1	Butterfly	Butterfly	AUX1	Butterfly	Butterfly
16	AUX1	AUX1	AUX1	Camber	Camber	Camber	Camber	Camber	Camber	Camber	Camber	Camber
DG1	SW	SW	SW	SW	SW	SW	SW	SW	SW	SW	SW	SW
DG2	SW	SW	SW	SW	SW	SW	SW	SW	SW	SW	SW	SW



RX CH	2AIL+4FLAP			4AIL+2FLAP			4AIL+4FLAP		
	Airplane	Glider		Airplane	Glider		Airplane	Glider	
		EP			EP			EP	
1	Aileron	Aileron	Aileron	Aileron	Aileron	Aileron	Aileron	Aileron	Aileron
2	Elevator	Elevator	Elevator	Elevator	Elevator	Elevator	Elevator	Elevator	Elevator
3	Throttle	Rudder	Rudder	Throttle	Rudder	Rudder	Throttle	Rudder	Rudder
4	Rudder	Aileron2	Aileron2	Rudder	Aileron2	Aileron2	Rudder	Aileron2	Aileron2
5	Gear	Flap	Flap	Gear	Aileron3	Aileron3	Gear	Aileron3	Aileron3
6	Aileron2	Flap2	Flap2	Aileron2	Aileron4	Aileron4	Aileron2	Aileron4	Aileron4
7	Flap	Flap3	Flap3	Aileron3	Flap	Flap	Aileron3	Flap	Flap
8	Flap2	Flap4	Flap4	Aileron4	Flap2	Flap2	Aileron4	Flap2	Flap2
9	Flap3	Motor	AUX7	Flap	Motor	AUX7	Flap	Flap3	Flap3
10	Flap4	AUX6	AUX6	Flap2	AUX6	AUX6	Flap2	Flap4	Flap4
11	AUX5	AUX5	AUX5	AUX5	AUX5	AUX5	Flap3	Motor	AUX7
12	AUX4	AUX4	AUX4	AUX4	AUX4	AUX4	Flap4	AUX6	AUX6
13	AUX3	AUX3	AUX3	AUX3	AUX3	AUX3	AUX5	AUX5	AUX5
14	AUX2	AUX2	AUX2	AUX2	AUX2	AUX2	AUX4	AUX4	AUX4
15	AUX1	Butterfly	Butterfly	AUX1	Butterfly	Butterfly	AUX3	Butterfly	Butterfly
16	Camber	Camber	Camber	Camber	Camber	Camber	Camber	Camber	Camber
DG1	SW	SW	SW	SW	SW	SW	SW	SW	SW
DG2	SW	SW	SW	SW	SW	SW	SW	SW	SW



●Ailevator

RX CH	1AIL			2AIL			2AIL+1FLAP			2AIL+2FLAP		
	Airplane	Glider		Airplane	Glider		Airplane	Glider		Airplane	Glider	
		EP			EP			EP			EP	
1	Aileron	Aileron	Aileron	Aileron	Aileron	Aileron	Aileron	Aileron	Aileron	Aileron	Aileron	Aileron
2	Elevator	Elevator	Elevator	Elevator	Elevator	Elevator	Elevator	Elevator	Elevator	Elevator	Elevator	Elevator
3	Throttle	Motor	AUX7	Throttle	Motor	AUX7	Throttle	Motor	AUX7	Throttle	Motor	AUX7
4	Rudder	Rudder	Rudder	Rudder	Rudder	Rudder	Rudder	Rudder	Rudder	Rudder	Rudder	Rudder
5	Gear	AUX6	AUX6	Gear	AUX6	AUX6	Elevator2	Elevator2	Elevator2	Elevator2	Elevator2	Elevator2
6	Airbrake	Airbrake	Airbrake	Aileron2	Aileron2	Aileron2	Aileron2	Aileron2	Aileron2	Aileron2	Aileron2	Aileron2
7	Elevator2	Elevator2	Elevator2	Elevator2	Elevator2	Elevator2	Flap	Flap	Flap	Flap	Flap	Flap
8	AUX5	AUX5	AUX5	AUX5	AUX5	AUX5	Gear	AUX6	AUX6	Flap2	Flap2	Flap2
9	AUX4	AUX4	AUX4	AUX4	AUX4	AUX4	AUX5	AUX5	AUX5	Gear	AUX6	AUX6
10	AUX3	AUX3	AUX3	AUX3	AUX3	AUX3	AUX4	AUX4	AUX4	AUX5	AUX5	AUX5
11	AUX2	AUX2	AUX2	AUX2	AUX2	AUX2	AUX3	AUX3	AUX3	AUX4	AUX4	AUX4
12	AUX1	AUX1	AUX1	AUX1	AUX1	AUX1	AUX2	AUX2	AUX2	AUX3	AUX3	AUX3
13	AUX1	AUX1	AUX1	AUX1	AUX1	AUX1	AUX1	AUX1	AUX1	AUX2	AUX2	AUX2
14	AUX1	AUX1	AUX1	AUX1	AUX1	AUX1	AUX1	AUX1	AUX1	AUX1	AUX1	AUX1
15	AUX1	AUX1	AUX1	AUX1	Butterfly	Butterfly	AUX1	Butterfly	Butterfly	AUX1	Butterfly	Butterfly
16	AUX1	AUX1	AUX1	Camber	Camber	Camber	Camber	Camber	Camber	Camber	Camber	Camber
DG1	SW	SW	SW	SW	SW	SW	SW	SW	SW	SW	SW	SW
DG2	SW	SW	SW	SW	SW	SW	SW	SW	SW	SW	SW	SW

The output CH of each system
 FASSTest 18CH
 FASSTest 12CH
 S-FHSS
 FASST 7CH
 FASST MULT
 T-FHSS

AIRPLANE

RX CH	2AIL+4FLAP			4AIL+2FLAP			4AIL+4FLAP		
	Airplane	Glider		Airplane	Glider		Airplane	Glider	
		EP			EP			EP	
1	Aileron	Aileron	Aileron	Aileron	Aileron	Aileron	Aileron	Aileron	Aileron
2	Elevator	Elevator	Elevator	Elevator	Elevator	Elevator	Elevator	Elevator	Elevator
3	Throttle	Motor	AUX7	Throttle	Motor	AUX7	Throttle	Motor	AUX7
4	Rudder	Rudder	Rudder	Rudder	Rudder	Rudder	Rudder	Rudder	Rudder
5	Elevator2	Elevator2	Elevator2	Elevator2	Elevator2	Elevator2	Elevator2	Elevator2	Elevator2
6	Aileron2	Aileron2	Aileron2	Aileron2	Aileron2	Aileron2	Aileron2	Aileron2	Aileron2
7	Flap	Flap	Flap	Aileron3	Aileron3	Aileron3	Aileron3	Aileron3	Aileron3
8	Flap2	Flap2	Flap2	Aileron4	Aileron4	Aileron4	Aileron4	Aileron4	Aileron4
9	Flap3	Flap3	Flap3	Flap	Flap	Flap	Flap	Flap	Flap
10	Flap4	Flap4	Flap4	Flap2	Flap2	Flap2	Flap2	Flap2	Flap2
11	Gear	AUX6	AUX6	Gear	AUX6	AUX6	Flap3	Flap3	Flap3
12	AUX5	AUX5	AUX5	AUX5	AUX5	AUX5	Flap4	Flap4	Flap4
13	AUX4	AUX4	AUX4	AUX4	AUX4	AUX4	Gear	AUX6	AUX6
14	AUX3	AUX3	AUX3	AUX3	AUX3	AUX3	AUX5	AUX5	AUX5
15	AUX2	Butterfly	Butterfly	AUX2	Butterfly	Butterfly	AUX4	Butterfly	Butterfly
16	Camber	Camber	Camber	Camber	Camber	Camber	Camber	Camber	Camber
DG1	SW	SW	SW	SW	SW	SW	SW	SW	SW
DG2	SW	SW	SW	SW	SW	SW	SW	SW	SW

The output CH of each system
 FASSTest 18CH
 FASSTest 12CH
 S-FHSS
 FASST 7CH
 FASST MULT
 T-FHSS

GLIDER

●Tail-less wing

AIRPLANE

RX CH	2AIL			2AIL+1FLAP			2AIL+2FLAP		
	Airplane	Glider		Airplane	Glider		Airplane	Glider	
		EP			EP			EP	
1	Aileron	Aileron	Aileron	Aileron	Aileron	Aileron	Aileron	Aileron	Aileron
2	AUX4	AUX4	AUX4	AUX4	AUX4	AUX4	AUX4	AUX4	AUX4
3	Throttle	Motor	AUX7	Throttle	Motor	AUX7	Throttle	Motor	AUX7
4	Rudder	Rudder	Rudder	Rudder	Rudder	Rudder	Rudder	Rudder	Rudder
5	Gear	AUX6	AUX6	Gear	AUX6	AUX6	Aileron2	Aileron2	Aileron2
6	Aileron2	Aileron2	Aileron2	Aileron2	Aileron2	Aileron2	Flap	Flap	Flap
7	AUX5	AUX5	AUX5	Flap	Flap	Flap	Flap2	Flap2	Flap2
8	AUX3	AUX3	AUX3	AUX5	AUX5	AUX5	Gear	AUX6	AUX6
9	AUX2	AUX2	AUX2	AUX3	AUX3	AUX3	AUX5	AUX5	AUX5
10	AUX1	AUX1	AUX1	AUX2	AUX2	AUX2	AUX3	AUX3	AUX3
11	AUX1	AUX1	AUX1	AUX1	AUX1	AUX1	AUX2	AUX2	AUX2
12	AUX1	AUX1	AUX1	AUX1	AUX1	AUX1	AUX1	AUX1	AUX1
13	AUX1	AUX1	AUX1	AUX1	AUX1	AUX1	AUX1	AUX1	AUX1
14	AUX1	AUX1	AUX1	AUX1	Butterfly	Butterfly	AUX1	Butterfly	Butterfly
15	Camber	Camber	Camber	Camber	Camber	Camber	Camber	Camber	Camber
16	Elevator	Elevator	Elevator	Elevator	Elevator	Elevator	Elevator	Elevator	Elevator
DG1	SW	SW	SW	SW	SW	SW	SW	SW	SW
DG2	SW	SW	SW	SW	SW	SW	SW	SW	SW

The output CH of each system
 FASSTest 18CH
 FASSTest 12CH
 S-FHSS
 FASST 7CH
 FASST MULT
 T-FHSS

GLIDER

RX CH	2AIL+4FLAP			4AIL+2FLAP			4AIL+4FLAP		
	Airplane	Glider		Airplane	Glider		Airplane	Glider	
		EP			EP			EP	
1	Aileron	Aileron	Aileron	Aileron	Aileron	Aileron	Aileron	Aileron	Aileron
2	Aileron2	Aileron2	Aileron2	Aileron2	Aileron2	Aileron2	Aileron2	Aileron2	Aileron2
3	Throttle	Motor	AUX7	Throttle	Motor	AUX7	Throttle	Motor	AUX7
4	Rudder	Rudder	Rudder	Rudder	Rudder	Rudder	Rudder	Rudder	Rudder
5	Flap	Flap	Flap	Aileron3	Aileron3	Aileron3	Aileron3	Aileron3	Aileron3
6	Flap2	Flap2	Flap2	Aileron4	Aileron4	Aileron4	Aileron4	Aileron4	Aileron4
7	Flap3	Flap3	Flap3	Flap	Flap	Flap	Flap	Flap	Flap
8	Flap4	Flap4	Flap4	Flap2	Flap2	Flap2	Flap2	Flap2	Flap2
9	AUX4	AUX4	AUX4	AUX4	AUX4	AUX4	Flap3	Flap3	Flap3
10	Gear	AUX6	AUX6	Gear	AUX6	AUX6	Flap4	Flap4	Flap4
11	AUX5	AUX5	AUX5	AUX5	AUX5	AUX5	AUX4	AUX4	AUX4
12	AUX3	AUX3	AUX3	AUX3	AUX3	AUX3	Gear	AUX6	AUX6
13	AUX2	AUX2	AUX2	AUX2	AUX2	AUX2	AUX5	AUX5	AUX5
14	AUX1	Butterfly	Butterfly	AUX1	Butterfly	Butterfly	AUX3	Butterfly	Butterfly
15	Camber	Camber	Camber	Camber	Camber	Camber	Camber	Camber	Camber
16	Elevator	Elevator	Elevator	Elevator	Elevator	Elevator	Elevator	Elevator	Elevator
DG1	SW	SW	SW	SW	SW	SW	SW	SW	SW
DG2	SW	SW	SW	SW	SW	SW	SW	SW	SW

The output CH of each system
 FASSTest 18CH
 FASSTest 12CH
 S-FHSS
 FASST 7CH
 FASST MULT
 T-FHSS

•Tail-less wing Winglet 2Rudder

RX CH	2AIL			2AIL+1FLAP			2AIL+2FLAP		
	Airplane	Glider		Airplane	Glider		Airplane	Glider	
		EP			EP			EP	
1	Aileron	Aileron	Aileron	Aileron	Aileron	Aileron	Aileron	Aileron	Aileron
2	RUD2	RUD2	RUD2	RUD2	RUD2	RUD2	RUD2	RUD2	RUD2
3	Throttle	Motor	AUX7	Throttle	Motor	AUX7	Throttle	Motor	AUX7
4	Rudder	Rudder	Rudder	Rudder	Rudder	Rudder	Rudder	Rudder	Rudder
5	Gear	AUX6	AUX6	Gear	AUX6	AUX6	Aileron2	Aileron2	Aileron2
6	Aileron2	Aileron2	Aileron2	Aileron2	Aileron2	Aileron2	Flap	Flap	Flap
7	AUX5	AUX5	AUX5	Flap	Flap	Flap	Flap2	Flap2	Flap2
8	AUX3	AUX3	AUX3	AUX5	AUX5	AUX5	Gear	AUX6	AUX6
9	AUX2	AUX2	AUX2	AUX3	AUX3	AUX3	AUX5	AUX5	AUX5
10	AUX1	AUX1	AUX1	AUX2	AUX2	AUX2	AUX3	AUX3	AUX3
11	AUX1	AUX1	AUX1	AUX1	AUX1	AUX1	AUX2	AUX2	AUX2
12	AUX1	AUX1	AUX1	AUX1	AUX1	AUX1	AUX1	AUX1	AUX1
13	AUX1	AUX1	AUX1	AUX1	AUX1	AUX1	AUX1	AUX1	AUX1
14	AUX1	AUX1	AUX1	AUX1	Butterfly	Butterfly	AUX1	Butterfly	Butterfly
15	Camber	Camber	Camber	Camber	Camber	Camber	Camber	Camber	Camber
16	Elevator	Elevator	Elevator	Elevator	Elevator	Elevator	Elevator	Elevator	Elevator
DG1	SW	SW	SW	SW	SW	SW	SW	SW	SW
DG2	SW	SW	SW	SW	SW	SW	SW	SW	SW



AIRPLANE

GLIDER

RX CH	2AIL+4FLAP			4AIL+2FLAP			4AIL+4FLAP		
	Airplane	Glider		Airplane	Glider		Airplane	Glider	
		EP			EP			EP	
1	Aileron	Aileron	Aileron	Aileron	Aileron	Aileron	Aileron	Aileron	Aileron
2	Aileron2	Aileron2	Aileron2	Aileron2	Aileron2	Aileron2	Aileron2	Aileron2	Aileron2
3	Throttle	Motor	AUX7	Throttle	Motor	AUX7	Throttle	Motor	AUX7
4	Rudder	Rudder	Rudder	Rudder	Rudder	Rudder	Rudder	Rudder	Rudder
5	Flap	Flap	Flap	Aileron3	Aileron3	Aileron3	Aileron3	Aileron3	Aileron3
6	Flap2	Flap2	Flap2	Aileron4	Aileron4	Aileron4	Aileron4	Aileron4	Aileron4
7	Flap3	Flap3	Flap3	Flap	Flap	Flap	Flap	Flap	Flap
8	Flap4	Flap4	Flap4	Flap2	Flap2	Flap2	Flap2	Flap2	Flap2
9	RUD2	RUD2	RUD2	RUD2	RUD2	RUD2	Flap3	Flap3	Flap3
10	Gear	AUX6	AUX6	Gear	AUX6	AUX6	Flap4	Flap4	Flap4
11	AUX5	AUX5	AUX5	AUX5	AUX5	AUX5	RUD2	RUD2	RUD2
12	AUX3	AUX3	AUX3	AUX3	AUX3	AUX3	Gear	AUX6	AUX6
13	AUX2	AUX2	AUX2	AUX2	AUX2	AUX2	AUX5	AUX5	AUX5
14	AUX1	Butterfly	Butterfly	AUX1	Butterfly	Butterfly	AUX3	Butterfly	Butterfly
15	Camber	Camber	Camber	Camber	Camber	Camber	Camber	Camber	Camber
16	Elevator	Elevator	Elevator	Elevator	Elevator	Elevator	Elevator	Elevator	Elevator
DG1	SW	SW	SW	SW	SW	SW	SW	SW	SW
DG2	SW	SW	SW	SW	SW	SW	SW	SW	SW



* Output channels differ by each system of a table. When using a system with few channels, there is a wing type which cannot be used. It cannot be used when there is a function required out of the range of the arrow of a figure.

●FASSTest 18CH/FASST MULTI/FASST 7CH/S-FHSS/T-FHSS

CH	H-4/H-4X Swash	All Other
1	Aileron	Aileron
2	Elevator	Elevator
3	Throttle	Throttle
4	Rudder	Rudder
5	Gyro	Gyro
6	Pitch	Pitch
7	Governor	Governor
8	Elevator2	Governor2
9	GYRO2	GYRO2
10	GYRO3	GYRO3
11	Governor2	Needle
12	Needle	AUX5
13		AUX4
14		AUX3
15		AUX2
16		AUX1
DG1		SW
DG2		

The output CH of each system
 FASSTest 18CH S-FHSS FASST 7CH
 FASST MULT T-FHSS

●FASSTest 12CH

CH	H-4/H-4X Swash	All Other
1	Aileron	Aileron
2	Elevator	Elevator
3	Throttle	Throttle
4	Elevator2	Rudder
5	Pitch	Pitch
6	Gyro	Gyro
7	Governor	Governor
8	Rudder	Governor2
9	GYRO2	GYRO2
10	GYRO3	GYRO3
DG1		SW
DG2		

The output CH of each system
 FASSTest 12CH

SYSTEM MENU

The System Menu sets up functions of the transmitter, this does not set up any model data.

- When the System Menu button is touched, the menu shown below is selected up. Touch the function button that you want to enter.

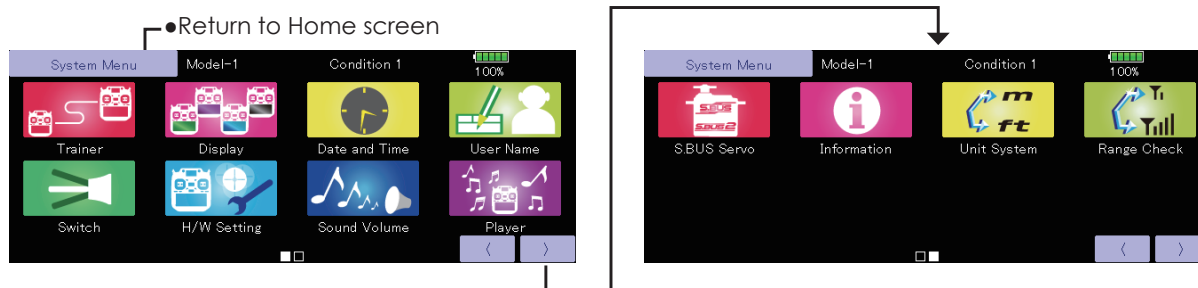

AIRPLANE

System Menu functions table

- **Trainer:** Starts and sets the trainer system.
- **Display:** Display adjustment and auto power off setting.
- **Date & Time:** Sets the date and time (system clock setting) and resets the timer.
- **User Name:** User name registration and ID Pin number.
- **Switch:** Toggle switch type setting (Set when the switch is replaced.)
- **H/W Setting:** Hardware reverse/Stick setting/Calibration.
- **Sound Volume:** Adjust the volume of: Key Operation/Error Warning/Trim & Center Click/Timer Event
- **Player:** Reproduction of music file.
- **S.BUS Servo:** S.BUS servo setting.
- **Information:** Displays the program version, microSD card information, and product ID.
- **Unit System:** The unit of a display is changed. (Metric↔Yard-Pound)
- **Range Check:** The output of the transmitter is lowered, for Range checking.

GLIDER

HELICOPTER



Trainer

Trainer system set up and use.

AIRPLANE

T32MZ trainer system makes it possible for the instructor to choose which channels and operation modes that can be used in the student's transmitter. The function and rate of each channel can be set, the training method can also be matched to the student's skill level. Two transmitters must be connected by an optional Trainer Cord, and the Instructors' transmitter should be programmed for trainer operation, as described below.

When the Instructor activates the trainer switch, the student has control of the aircraft (if MIX/FUNC/NORM mode is turned on, the Instructor can make corrections while the student has control). When the switch is released the Instructor regains control. This is very useful if the student gets the aircraft into an undesirable situation.

- Setting data are stored to model data.
- Student rate can be adjusted at MIX/FUNC/NORM mode.
- Activated student channels can be selected by switches.

Notes: This trainer system can be used in the following manner;

1. In the T32MZ transmitter and the other transmitter, if the channel order is different. It is necessary to match the channel order in the Linkage Menu when connecting it with other than a T32MZ. Or use "Trainer student channel setting function"
2. Be sure that all channels work correctly in both transmitters before flying.

Corresponding types of transmitters and trainer mode settings:

Types of transmitters		Instructor's transmitter settings		Student's transmitter settings			Trainer Cords
Instructor	Student	Freq. setting Mod. mode	Trainer setting CH mode	Freq. setting Mod. mode	Trainer setting CH mode	Mod. mode	
T32MZ, T18MZ, T18SZ, T14SG, FX-22, FX-36	T32MZ, T18MZ, T18SZ, T14SG, FX-22, FX-36	Arbitrary	16CH	Arbitrary	16CH	-	12FG/9C Trainer Cords
T32MZ	T14MZ, FX-40, T12Z, T12FG, FX-30	Arbitrary	12CH	PCM-G3 2.4G	12CH	PPM	
T32MZ	T8FG, FX-20	Arbitrary	12CH 8CH	FASST-MLT2 FASST-MULT	-	-	12FG Trainer Cords
T32MZ	T10C, T9C, T7C, T6EX, T4EX	Arbitrary	8CH	PPM	-	-	
T32MZ	T10CG, T7CG	Arbitrary	8CH	Arbitrary	-	-	12FG Trainer Cords
T32MZ	T10J, T8J, T6J, T6K	Arbitrary	8CH	Arbitrary	-	-	12FG/9C Trainer Cords
T14MZ, FX-40, T12Z, T12FG, FX-30	T32MZ	Arbitrary	12CH	Arbitrary	12CH	-	
T8FG, FX-20	T32MZ	Arbitrary	12CH	Arbitrary	12CH	-	
T10C, T10CG, T10J, T9C, T7C, T7CG, T8J, T6K	T32MZ	Arbitrary	-	Arbitrary	8CH	-	

- Touch the [Trainer] button in the System Menu to call the setup screen. The setup screen for the Teacher/Student mode is shown below.

•Return to System Menu

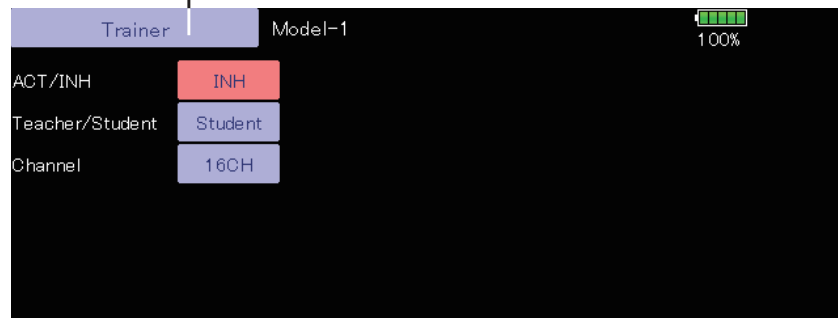

HELICOPTER

Student mode

1. Set "Teacher/Student" button to "Student".
2. Change "ACT/INH" button from "INH" to "OFF" or "ON".
3. Set the CH mode to "16CH/12CH" or "8CH", see the above chart for the trainer mode settings.

Note: When using T32MZ on the student side, it is necessary to turn on the power switch. (For other transmitters, the student may use it off.)

- The setup screen for the instructor mode is shown below.

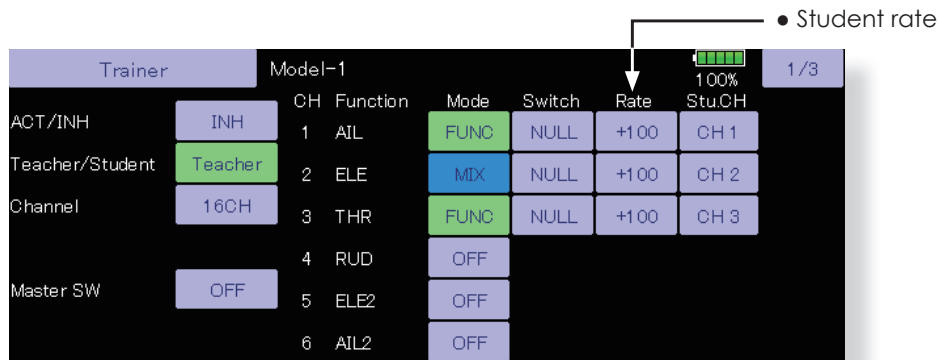
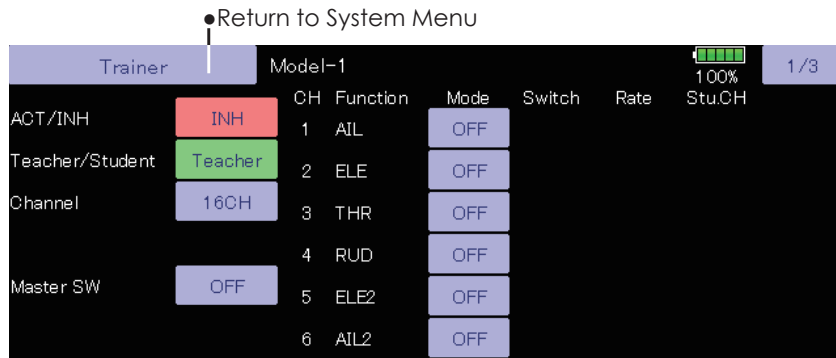

Teacher mode

1. Set "Teacher/Student" button to "Teacher".
2. Change "ACT/INH" button from "INH" to "OFF" or "ON".
3. Set the CH mode to "16CH/12CH" or "8CH", see the above-mentioned chart for the trainer mode settings.
4. Call up the Switch Setting screen by touching "Switch". Then set the desired switch and on/off direction.
5. Select the switch mode. If you select "NORM", the trainer function will be turned on or off by a switch position. If you select "ALT", ON and OFF of the trainer function switches alternatively every time the switch is turned on. This means the student side can be operated without holding the switch lever.
6. The Instructor side selects the channel for control. Three operating modes are available.

"NORM" mode (Normal mode);

The student will have none of the settings from the Teachers radio.

"MIX" mode;

Student has full advantage of all mixes and settings in Teachers radio. Plus the Teacher has the ability to override the student while the switch is activated.

"FUNC" mode (Function mode);

Student has control of all mixes and rate settings of Teachers radio.

7. Set the switches and rates of each channel.

Switch to the details setup screen by touching the page switching button [1/2] at the top right-hand corner of the screen. Student operation for each channel can be set here.

[Switch]: The switches that can be operated by the student can be set. SW-A~SW-J can be selected.

[Rate]: Servo travel versus student operation can be set. (This can only be used in the FUNC/MIX/NORM modes.)

Note: In "teacher mode", the trainer function won't show that it is activated unless the Instructor's transmitter receives signals from the student's transmitter via the trainer cord. Be sure to confirm this after connecting your trainer cable.

Trainer student channel setting function

The channel function can be selected and re-arranged for the student transmitter (when using either "FUNC" "MIX" "NORM") in the Trainer function of the transmitter. This makes trainer connection easy even when the instructor and student channel assignment are different.

<Example of student CH setting>

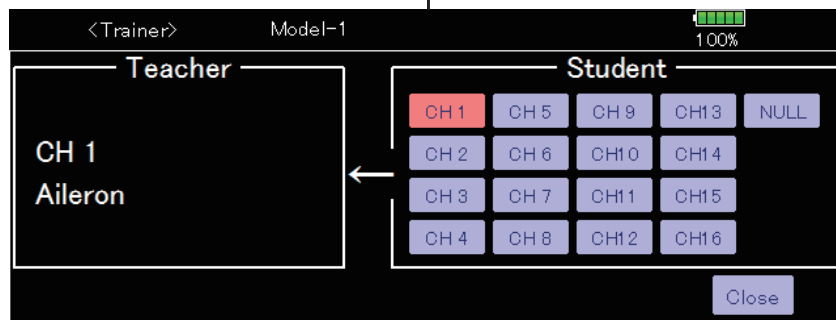
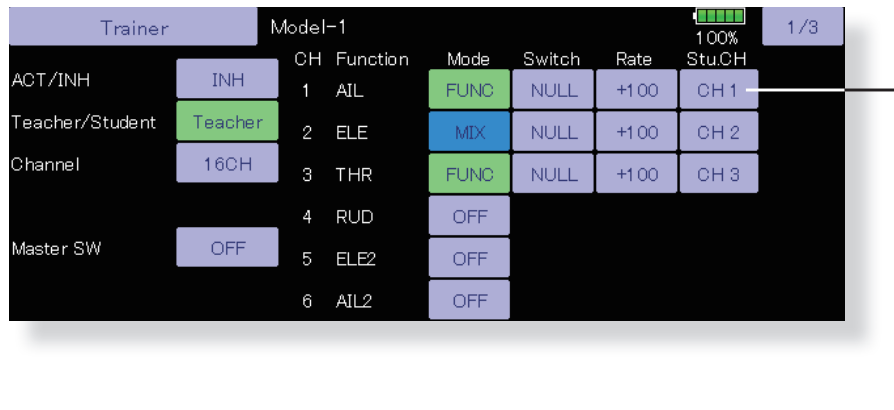
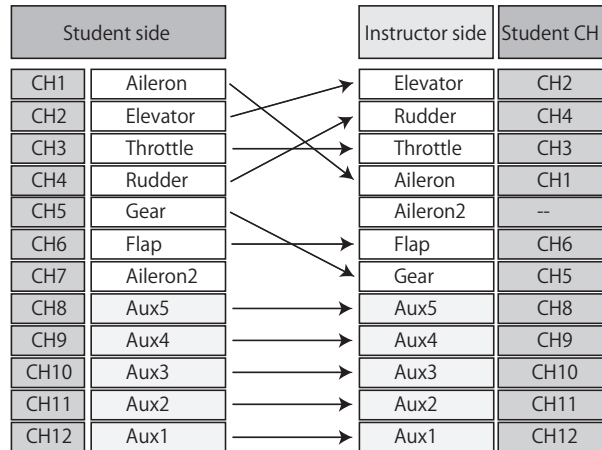

Student channel setting

1. Open the System Menu trainer screen.
2. Select [Teacher].
3. When [FUNC][MIX][NORM] is selected as the mode of the channel to be set, the [Student CH] setting button is displayed. (When [OFF],[Student CH] setting is not performed.)
4. When the [Student CH] button is pressed, the Channel Select screen is displayed. Select the channel.
 - (16CH mode---1-16CH)
 - (12CH mode---1-12CH)
 - (8CH mode---1-8CH)

Display

LCD screen adjustment and auto power off setting



The following LCD screen adjustments and auto power off setting are possible:

- Auto power off time setting
 - Backlighting brightness adjustment
 - Background color change
 - Touch panel screen calibration and touch-panel lock correction
- Touch the [Display] button in the System Menu to call the setup screen shown below.

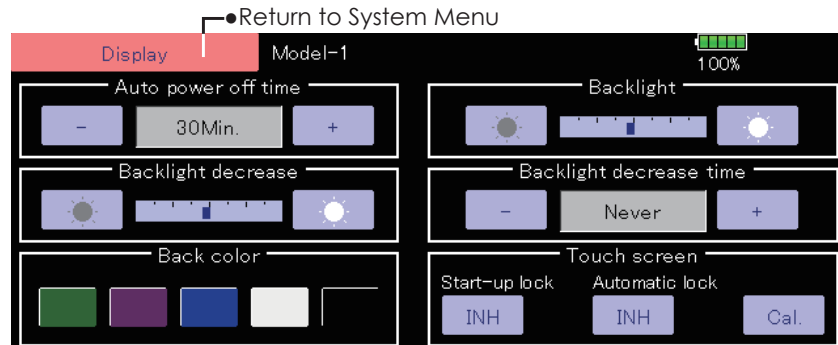

Auto power off time setting

The function to prevent a battery from discharging by failure of the power supply of a transmitter to erase.

1. Adjust the auto power off time with the left and right side buttons.

*When the time the transmitter is inactive reaches the set time, the power is turned off automatically. This time can be set up to 1 hour in 10 minutes increments. The auto power off function can also be deactivated.

*An audible alarm is sounded and an alarm screen is displayed from 3 minutes before auto power off and the time remaining until auto power off is displayed. When a stick or switch is operated while the alarm screen is being displayed, the alarm is cleared and the display is returned to the home screen.

Backlighting brightness adjustment

1. Adjust the backlighting brightness with the left and right side buttons.

*When the right side button is touched, the backlighting becomes brighter. When the left side button is touched, the backlighting becomes darker.

Backlight decrease brightness adjustment

1. Adjust the backlight decrease brightness with the left and right side buttons.

*When the right side button is touched, the backlighting becomes brighter. When the left side button is touched, the backlighting becomes darker.

*It cannot be made brighter than Backlighting brightness adjustment.

Backlight decrease time

You can set a time period to decrease the LCD backlight. This function counts the period that the touch panel has not been operated. This time can be set by ten-second steps. You can also turn off the "backlight decrease" if you like.

*The backlight consumes a large amount of power. We recommend you to turn off the backlight by setting the backlight power-off time to about one minute.

Background color

1. Touch the button of the color you want to change.

*There are five background colors.

Touch screen

[Start-up lock] INH ⇒ ON, it is touch-panel locked whenever it turns on the power supply of T32MZ. It will be canceled if HOME/EXIT and U.MENU/MON. key are pushed simultaneously.

[Automatic lock] INH ⇒ ON, It synchronizes with Backlight decrease time and becomes a panel lock. It will be canceled if HOME/EXIT and U.MENU/MON. key are pushed simultaneously.

[Cal.]calibration This function adjusts the location of touch panel. Touch "Calibration" button and then press "Yes", the calibration screen will pop up. Touch the center of the cross hair cursor on the screen with the stylus pen. As soon as the system recognizes the position, the cursor will move on to the next position. Repeat this procedure as long as the cursor moves to next position. You will do this five times. Calibration will be carried out based on the five positions. Disappearance of the cross hair cursor means the calibration has been completed. Touch any point on the screen to return to the previous screen.

*In ordinary operation, this calibration is not necessary. If you notice the touch panel is not functioning correctly after long use, we recommend you carry out this calibration.

AIRPLANE

GLIDER

HELICOPTER



Date and Time

Date and time setting (system clock setting) and integrating timer resetting

This function adjusts the system clock of the T32MZ transmitter. Perform this setting when you purchase the set and when adjustment is necessary.

The integrating timer can also be reset.

*The integrating timer is displayed on the Home screen.

AIRPLANE

- Touch the [Date and Time] button in the System Menu to call the setup screen shown below.

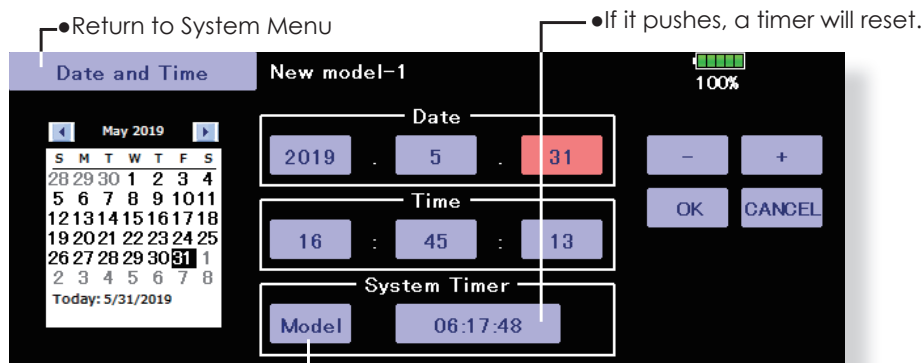

- Total : Regardless of a model, additional time in case a power supply ON is displayed.
- Model : The additional time when the power supply was set to ON is displayed for every model.

GLIDER

Date setting

1. Touch the "Year", "Month", or "Day" button and set the date by touching the [+] or [-] button.
2. Press the [OK] button to confirm. Press the [Cancel] button to return to the previous settings.

*The date can also be set by pressing the date on the calendar shown at the left.

Time setting

1. Touch the "Hour" or "Minute" button, and set the time by touching the [+] or [-] button.
2. Press the [OK] button to confirm. Press the [Cancel] button to return to the previous settings.
3. When the "Second" button is touched, the timer is set to "00" seconds.

Integrating timer reset

The integrating timer shows the total time that has elapsed since the last "reset".

1. When the [System Timer] button is touched, the timer is reset.

HELICOPTER



This function registers the T32MZ user name.

A PIN can also be set to protect the set data or user name.

*Set the PIN carefully. When a system PIN is set, if you forget the PIN, none of the settings can be changed. In this case, the system must be reset by the Futaba Service Center.

- Touch the [User Name] button in the System Menu to call the setup screen shown below.

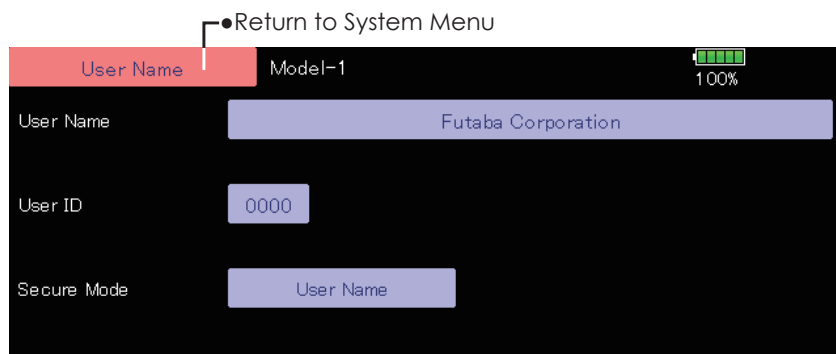

User name registration

1. When the User Name box is touched, a keyboard appears on the screen.
2. Enter the user name from this keyboard.

*A user name of up to 32 characters can be entered.

*The set user name is displayed on the Home screen.

(For a detailed description of the input method, see [User Name Registration/Character Input Method] in the Basic Operation section.)

User name or set data protection

1. Touch the Security Mode button and select the mode. The mode is switched each time the button is touched.

*User Name: Select when you want to protect the user name only.

*System: Select when you want to protect all the set data.

2. When the user ID button is touched, a PIN input screen appears. Input a PIN of up to 4 digits.

3. When the "Return" key is touched, the display returns to the preceding screen.

4. When the transmitter power is turned off, the set security mode becomes active.

*When a PIN is set for the user name, it must be entered the each time the User Name screen is opened.

When a System PIN is set, a button displaying a key icon appears on the Home screen.

When you want to change any settings, touch this button and enter the PIN.

If you want to nullify your current password, set the password to "0000" (default value).

Switch

Toggle switch type setting (Setting when the switch was replaced.)

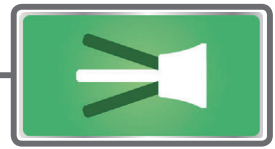

If you modify the location of the switches on the right and left (top) of the transmitter, you should be sure to re-assign functions to the switches for proper operation.

A "Lock" is included to prevent settings from being modified by mistake. When you need to change settings, unlock this by pressing "Lock". It will then read "Unlock" and you can make changes as required.

AIRPLANE

- Touch the [Switch] button in the System Menu to call up the setup screen shown below.

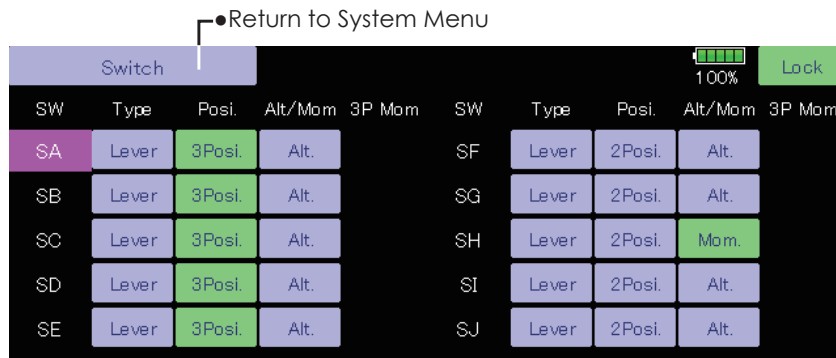

GLIDER

Switch selection

1. Select the switch type by touching the [Type] button corresponding to the switch to be replaced.
 [Lever]: Toggle switch
 [Button]: Push button
 [Dial]: Knob
- Setting for toggle switch is shown above.

2/3 position selection

1. Touch the "Posi." button corresponding to the switch and select the position type.
 [2 Posi]: 2 position
 [3 Posi]: 3 position

[Alt/Mom] mode selection

1. Select the operation mode by touching the [Alt/Mom] button corresponding to the switch.
 [Alt.]: Alternate type
 [Mom.]: Self-return type
- Selection of the [Mom.] mode with a 3-position type switch is shown above.

"3P Mom" mode selection

1. Select the operation mode by touching the "3P Mom" button corresponding to the switch.
 [Single]: One-side self-return type
 [Dual]: Both directions self-return type

HELICOPTER



H/W Setting

Stick, switch, trim lever, and knob operation direction reversal (Hardware reverse)/Stick response and hysteresis adjustment (Stick Setting)/Calibration

This function is for adjusting the sticks, switches, and trim characteristics. It is not unless necessary.

H/W Reverse

This function reverses the operation signal of the sticks, switches, trimmer levers, and knobs.

Note: This setting reverses the actual operation signal, but does not change the display of the indicators on the display. Use the Normal mode as long as there is no special reason to use the Reverse mode.

- Touch the [H/W Setting] button at the System Menu to call the setup screen shown below.

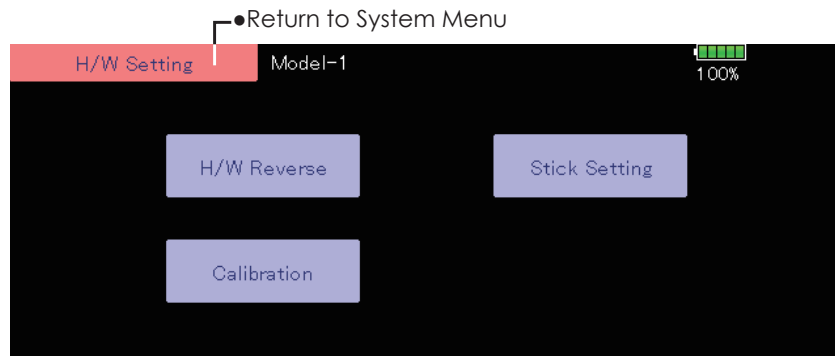

- Touch the [H/W Reverse] button at the H/W Setting Menu to call the setup screen shown below.

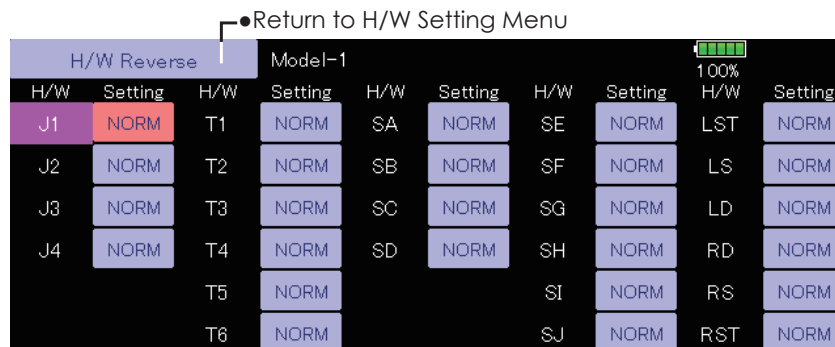

Operation direction reversal method

1. Touch the setting button corresponding to the H/W (Hardware) you want to reverse.
2. Reverse the H/W by touching [Yes]. (When you want to stop operation, touch [No].)
 [Normal]: Normal operation direction
 [Reverse]: Reverses the operation direction.

AIRPLANE

GLIDER

HELICOPTER

- Touch the [Stick Setting] button at the H/W Setting Menu to call the setup screen shown below.

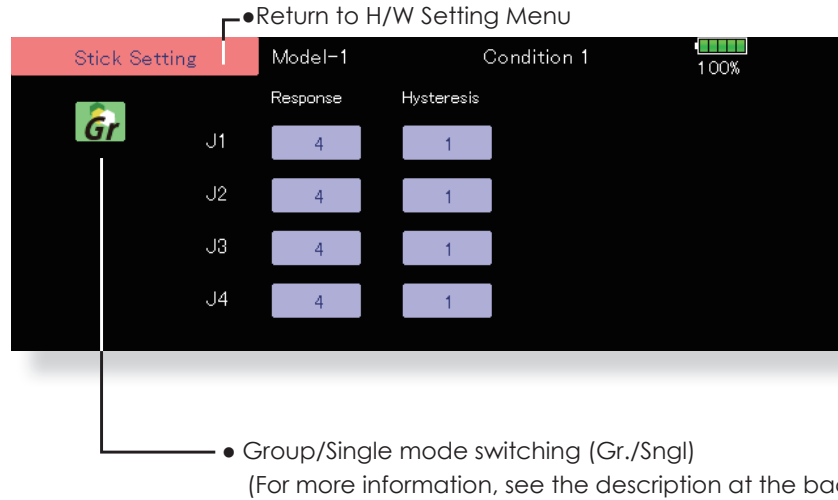

AIRPLANE

Response adjustment

1. Touch the setting button corresponding to the stick with the response you want to adjust. Adjustment buttons appear on the right-hand side of the stick setup screen.
2. Use the adjustment buttons to adjust the response.
Initial value: 4
Adjustment range: 1~16 (When the adjustment value is large, the response becomes slow.)

Hysteresis adjustment

1. Touch the setting button corresponding to the stick whose hysteresis you want to adjust. Adjustment buttons appear on the right-hand side of the stick setup screen.
2. Use the adjustment buttons to adjust the hysteresis.
Initial value: 1
Adjustment range: 0~32 (When the adjustment value is large, the hysteresis value becomes large.)

GLIDER

- Touch the [Calibration] button at the H/W Setting Menu to call the setup screen shown below.

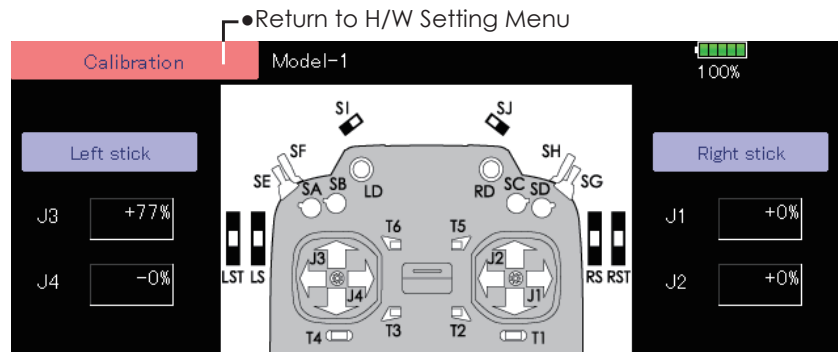

HELICOPTER

How to Calibrate

1. Choose the stick to calibrate right and left.
2. The stick is set at neutral and the [neutral] button is pushed.
3. The stick is held at full right and full bottom (diagonal) the [Right/Bottom] button is pushed.
4. The stick is held at full left and full top (diagonal) the [Left/Top] button is pushed.

*Please do not press the stick too firmly in any direction when doing the calibration.

*Check after calibration to make sure that neutral is 0% and bottom right side will be +100%, and the top left side is become -100%.

Sound Volume

Sound Volume setting



This function can set the volume of "Key Operation", "Error/Warning", "Trim & Center Click" and "Timer Event" respectively.

*If you have set the PIN try not to forget it. When a system PIN is set, if you forget the PIN, none of the settings can be changed or entered. In this case, the system must be reset by the Futaba Service Center.

- Touch the [Sound Volume] button in the System Menu to call the setup screen shown below.

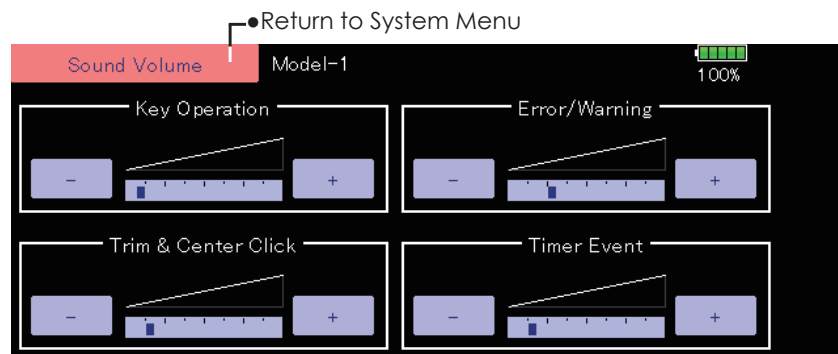

Sound Volume Setting method

1. When the Sound Volume box is touched, the above screen will appear.
2. You can change the sound volume by touching the "+" "-" button of four items.

*If you touch "+", the volume will increase. If you touch the "-", the volume will decrease.

AIRPLANE

GLIDER

HELICOPTER

Player

Music playback

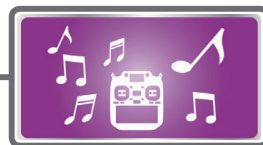

The T32MZ transmitter can play back ".wma" music files stored in your microSD card. You can listen to them through the built-in speaker or through the headphone jack with your own headphones.

[Important notice]

Before downloading files from your PC into the microSD card, insert the microSD card into the transmitter and turn on the power of the transmitter. Then the following folders will be automatically created in the microSD card. When you download files from you PC, copy and paste the files into their corresponding files.

- BMP : picture files
- WMA : music files
- WAV : sound files
- MODEL : model data files

AIRPLANE

- Push the Music Playback button on the home screen to call the following set-up screen.

GLIDER

• Return to the home screen

• Button to select either One-time Playback or Repeat Playback

• Button to select either One Music Playback or Multiple Music Playback

• SW selection button
Push this button to call the SW select screen and choose the Music playback switch.
(Refer to the description in the end of this manual)

(Playback file list)

Buttons for music playback

- You can playback any music files listed on the right side of the screen.
- If you adjust the volume here, it adjusts not only music playback but also other applications.

To playback

- All the music files saved in the T32MZ/ microSD card will be shown here.
1. Push the file name to select the music file you want to hear.
 2. Use the buttons on the left to playback or stop the music.

HELICOPTER

Copy/Delete/Rename

1. Data is chosen from Playback File.
2. Select data file.
3. Copy/Delete or Rename the file.
4. Select [Yes] or [No] to either confirm or deny the changes you wish to do.

S.BUS Servo

S.BUS servo setting

An S.BUS servo can memorize the channel and various settings itself. Servo setting can be performed on the T32MZ screen by wiring the servo as shown in the figure.

• Servo ID number

Individual ID numbers are memorized for your S.BUS servos in your T32MZ. When a servo is used (as shown at the right), the servo ID number is automatically read by the transmitter.

If you use multiple S.BUS servos and do not want to change the settings on all that are mounted in a fuselage, only the desired servo in the group can be set by entering the ID of that specific servo.

- * S9070SB cannot be arranged by T32MZ.
- * With S.BUS servos of use, there are a function which can be used, and an impossible function and a display screen changes.
(Only the function which can be used by a servo is displayed.)

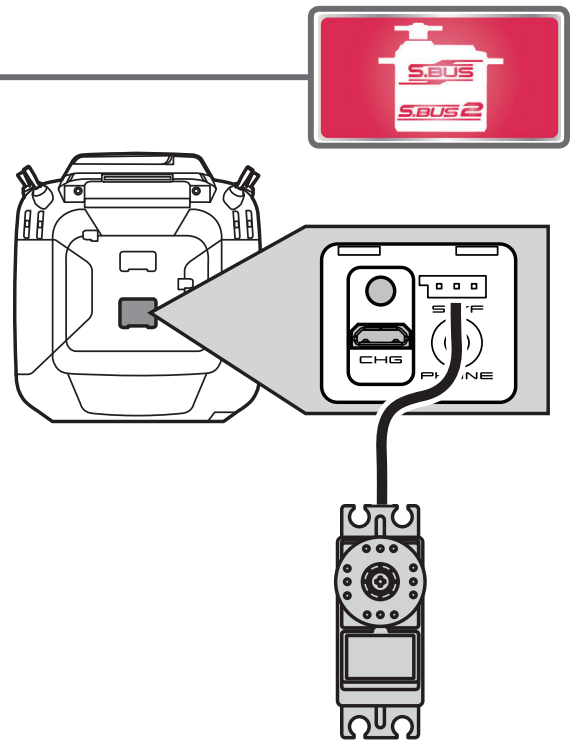

S.BUS servo

AIRPLANE

- Call the following setting screen by pressing the [S.BUS Servo] button in the System Menu.

* After reading completion, with connection of the above figure, if a stick is moved, the test of operation of the servo can be operated and carried out.

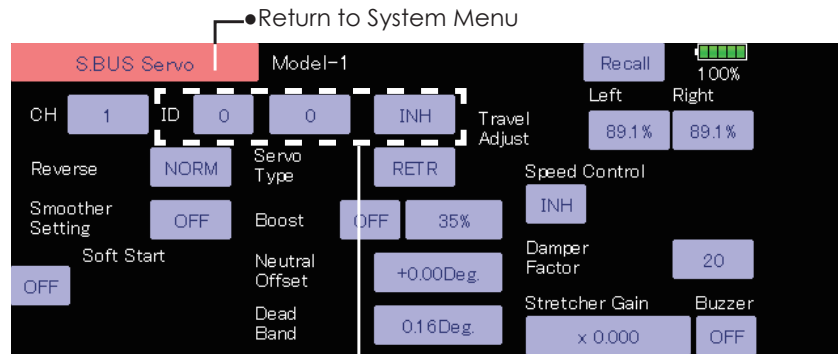

Procedure for changing S.BUS servo setting

1. Select [S.BUS Servo] of the System Menu.
2. Wire the servo as shown in the figure above.
3. Press [Recall]. The ID and current setting of that servo are displayed.
4. When multiple servos are connected change [INH] at the right side of the ID number on the screen to [ACT] and enter the ID of the servo you want to set.
5. Set each item. (Please see the next page.)
6. Press [Write]. The settings are changed.

⚠ WARNING

- ❗ While S.BUS servo writes, you aren't supposed to remove a connection of a servo and turn off a power supply of a transmitter.

*Data of S.BUS servo is damaged and breaks down.

Servo ID input example

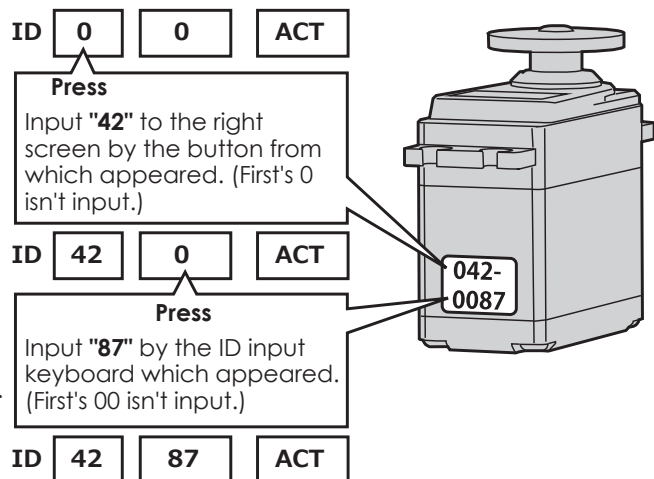

GLIDER

HELICOPTER

S.BUS Servo Description of function of each parameter

*There are functions which can be used according to the kind of servo, and an impossible function.

• ID

Displays the ID of the servo whose parameters are to be read. It cannot be changed.

• Channel

Channel of the S.BUS system assigned to the servo. Always assign a channel before use.

• Reverse

The direction in which the servo rotates can be changed.

• Servo type

■ Normal: Normal operation mode

■ Retract: Landing gear retract mode. When a load is applied to the servo for 30 seconds without any channel operation performed from the transmitter, the current consumption is suppressed by widening the dead band to 40°. When channel operation is performed from the transmitter, or the servo is moved outside the expanded dead band by an outside force, dead band expansion is reset and returns to the original operation.

■ O.L.P. : This is the Over Load Protection mode. When a servo horn has been locked for more than 5 seconds by a load, the servo output turns off to protect the servo.

* The normal mode and retract mode are applicable only to the S3171SB, S9071SB, S9072SB, S9074SB, and S9075SB

• Soft Start

Restricts operation in the specified direction the instant the power is turned on. By using this setting, the first initial movement when the power is turned on slowly moves the servo to the specified position.

• Stop Mode

The state of the servo when the servo input signal is lost can be specified. The "Hold" mode setting holds the servo in its last commanded position even if using AM or FM system.

• Smoother

This function changes smoothness of the servo operation relative to stick movement changes. Smooth setting is used for normal flight. Select the "OFF" mode when quick operation is necessary such as 3D.

• Neutral Offset

The neutral position can be changed. When the neutral offset is large value, the servo's range of travel is restricted on one side.

• Speed Control

Speeds can be matched by specifying the operating speed. The speed of multiple servos can be matched without being affected by motor fluctuations. This is effective for load torques below the maximum torque.

However, note that the maximum speed will not exceed what the servo is capable of even if the servos operating voltage is increased.

• Dead band

The dead band angle at stopping can be specified.

[Relationship between dead band set value and servo operation]

Small → Dead band angle is small and the servo is immediately operated by a small signal change.

Large → Dead band angle is large and the servo does not operate at small signal changes.

(Note) If the dead band angle is too small, the servo will operate continuously and the current consumption will increase and the life of the servo will be shortened.

• Travel Adjust

The left and right travels centered about the neutral position can be set independently.

• Boost

The minimum current applied to the internal motor when starting the servo can be set. Since a small travel does not start the motor, it essentially feels like the dead band was expanded. The motor can be immediately started by adjusting the minimum current which can start the motor.

[Relationship between boost set value and servo operation]

Small → Motor reacts to a minute current and operation becomes smooth.

Large → Initial response improves and output torque increases. However, if the torque is too large, operation will become rough.

• Boost ON/OFF

OFF : It is the boost ON at the time of low-speed operation. (In the case of usual)

ON : It is always the boost ON. (When quick operation is hope)

• Damper

The characteristic when the servo is stopped can be set.

When smaller than the standard value, the characteristic becomes an overshoot characteristic. If the value is larger than the standard value, the brake is applied before the stop position.

Especially, when a large load is applied, overshoot, etc. are suppressed by inertia and hunting may occur, depending on the conditions. If hunting (phenomena which cause the servo to oscillate) occurs even though the Dead Band, Stretcher, Boost and other parameters are suitable, adjust this parameter to a value larger than the initial value.

[Relationship between damper set value and servo operation]

Small → When you want to overshoot. Set so that hunting does not occur.

Large → When you want to operate so that braking is not applied. However, it will feel like the servo response has worsened.

(Note) If used in the hunting state, not only will the current consumption increase, but the life of the servo will also be shortened.

• Stretcher

The servo hold characteristic can be set. The torque which attempts to return the servo to the target position when the current servo position has deviated from the target position can be adjusted.

This is used when stopping hunting, etc., but the holding characteristic changes as shown below.

[Relationship between stretcher and servo operation]

Small → Servo holding force becomes weaker.

Large → Servo holding force becomes stronger.

(Note) When this parameter is large, the current consumption increases.

• Buzzer

When the power supply of a servo is previously turned on at the time of a power supply injection without taking transmit of a transmitter, the buzzer sound of about 2.5 Hz continues sounding from a servo.

(Even when the transmit of a transmitter is taken out previously, a buzzer sounds until the signal of a servo is outputted normally, but it is not unusual.)

The transmitter has been turned OFF ahead of a servo power supply → The buzzer sound of about 1.25 Hz continues sounding as servo power supply end failure alarm.

(Do not insert or remove the servo connector while the receiver power is ON. A buzzer may sound by incorrect recognition.)

*Buzzer sound is generated by vibrating the motor of a servo.

Since current is consumed and a servo generates heat, please do not operate the number more than needed or do not continue sounding a buzzer for a long time.



Information

The program version, microSD card data, and product ID are displayed. The language used by the system can also be changed.

The Information screen displays the T32MZ system program version information, T32MZ, microSD card (memory size, vacant capacity, number of model data, and number of music files) information and product ID.

*When an microSD card are not inserted, their information is not displayed.

AIRPLANE

- Touch the [Information] button at the System Menu to call the setup screen shown below.

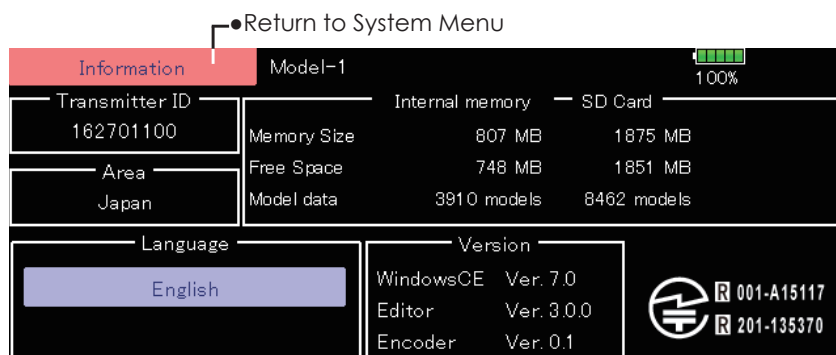

GLIDER

HELICOPTER

Unit System

The unit of the numerical value displayed by a telemetry can be chosen as one of the metric system and the yard-pound systems.



► Metric

Distance	m	meter
Altitude	m	meter
Speed	km/h	kilometers per hour
Variometer	m/s	meters per second
Temperature	°C	degrees Celsius
Atmospheric pressure	hPa	hectopascal

► Yard-pound

Distance	yd	yard
Altitude	ft	foot
Speed	mph	miles per hour
Variometer	fpm	feet per minute
Temperature	°F	degrees Fahrenheit
Atmospheric pressure	inHg	inch of mercury

- Touch the [Unit System] button at the System Menu to call the setup screen shown below.

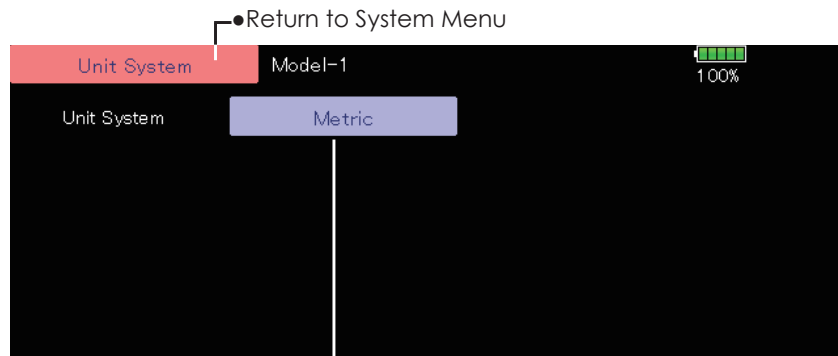

- Touch the [Metric] button. [Metric] ↔ [Yard-pound]
It chooses. "Sure?" → [Yes] push.

AIRPLANE

GLIDER

HELICOPTER



Range check

Before a flight ground range check.

The 'range check mode' reduces the transmission range of the radio waves to allow for a ground range check.

*The range check mode, when activated, will continue for 90 seconds unless the user exits this mode early. When the progress bar reaches 90 second mark, the RF transmission automatically returns to the normal operating power.

⚠ WARNING

⊘ Do not fly in the range check mode.

*Since the range of the radio waves is short, if the model is too far from the transmitter, control will be lost and the model will crash.

AIRPLANE

- Pushing [U.MENU/MON.]Key is continued. → Turn ON the transmitter's power switch
→ [U.MENU/MON.] Key will be released if the screen of "Transmit?" comes out.



- [NO] is pushed.

GLIDER

- Touch the [Range Check] button at the System Menu to call the setup screen shown below.

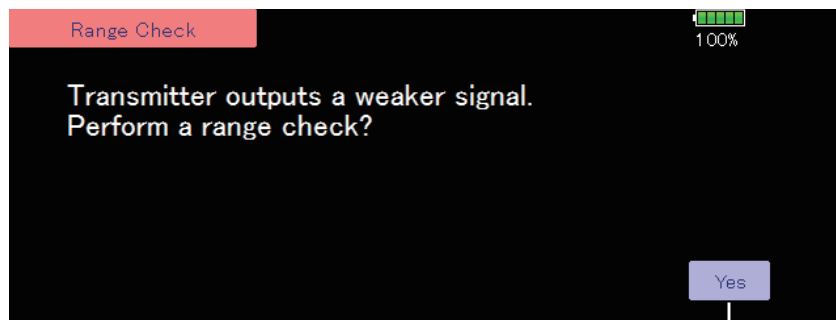

- [Yes] is pushed.

Rotation Range Check method

HELICOPTER

1. Pushing [U.MENU/MON.] Key is continued. →Turn ON the transmitter's power switch. Select [No].
*For safety, the RANGE CHECK mode can not be selected while the RF transmission is active.
2. In the system menu, choose the 'Range Check' selection from the menu options.
3. The Range Check screen is displayed. To activate the Range Check mode press the [Yes] button. During the Range Check period, the RF power is reduced to allow the ground range tests to be performed.
4. The Range Check function automatically exits after the 90 second time limit has expired. The progress bar is displayed on the transmitter's screen. Should you complete the range check before the 90 seconds has pressed, press the [Exit] button.
*When the [RESTART] button is pressed, the range check mode timer is returned to 0.

*Please note, upon expiration of the 90 seconds, or when [Exit] is selected, the transmitter will automatically return to the normal RF operation as noted on the display.

*Once the 32MZ is transmitting at full power, it is not possible to enter the Range Check mode without first switching the transmitter Off and back On. This has been designed to prevent a modeler from inadvertently flying in the Range Check mode.

5. When the [Exit] button is pressed, the Range Check mode is disabled and the 32MZ will begin transmitting at full power.

*After exiting the Range Check mode, the function cannot be selected again. To select the Range Check mode again you must cycle the transmitter power switch.

LINKAGE MENU

The Linkage Menu has all of the functions you will need to perform model addition, model type selection, frequency setting, end point setting, and other model basic settings.

The functions which can be selected depend on which model type you are using. A typical menu screen is shown below.

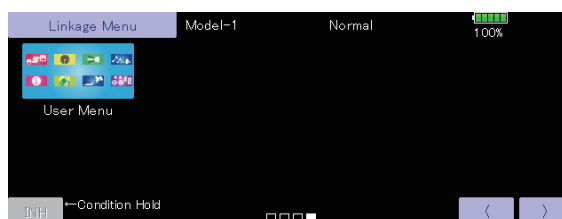
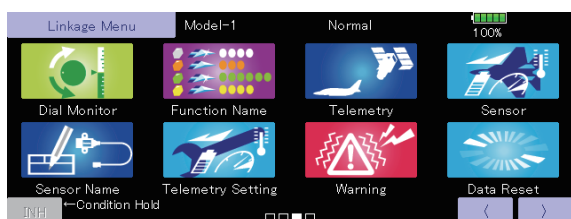
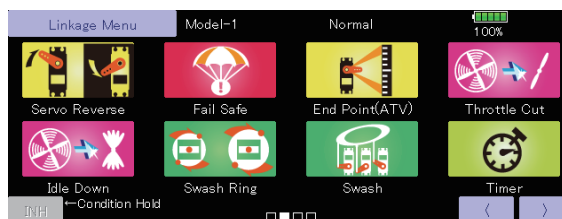
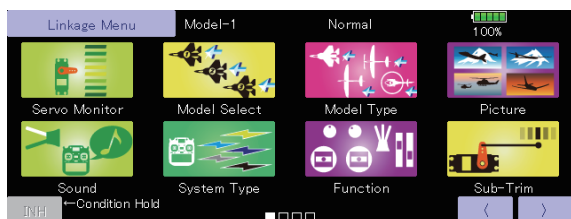

AIRPLANE

GLIDER

HELICOPTER

Linkage Menu functions table

- **Servo Monitor:** Displays the servo test and operation position
- **Model Select:** Model addition, call, deletion, copy, model name setting
- **Model Type:** Model type, wing type, switch type, etc. selection
- **Picture:** Picture selection and setting for each model
- **Sound:** Sound recording and playback
- **System Type:** System selection, receiver link, telemetry.
- **Function:** Channel assignment of each function can be changed
- **Sub-Trim:** Adjusts the neutral position of each servo
- **Servo Reverse:** Servo direction reversal
- **Fail Safe:** Fail safe function and battery fail safe function setting
- **End Point (ATV):** Servo basic rudder adjustment and limit setting
- **Throttle Cut:** Stops the engine safely and easily (airplane and helicopter only)
- **Idle Down:** Lowers the idle speed of the engine (airplane and helicopter only)
- **Swash Ring:** Limits the swash travel within a fixed range to prevent linkage damage (helicopter only)
- **Swash:** Swash AFR and linkage correction function (helicopter only)
- **Timer:** Timer setting and lap time display
- **Dial Monitor:** Dial, slider, and digital trim position display and setting
- **Function Name:** Function Name can be changed
- **Telemetry:** Displays various data sent from the receiver
- **Sensor:** Various telemetry sensors setting
- **Sensor Name:** Change of a sensor name
- **Telemetry Setting:** Data logging of telemetry
- **Warning:** Warning sound and vibration setting
- **Data Reset:** Model memory data reset (by various item)
- **User Menu:** Create an original menu that you often use

Servo Monitor

Servo Test & Graph Display/Displays servo positions.

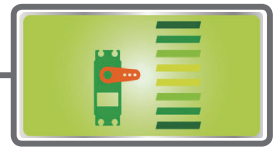

This is used for testing servo movement. Touch “Moving Test” (repetition mode) or “Neutral Test” (fixed position mode) depending on which one shows on the screen. To get from one to the other, simply touch the field again, and you will move from “Moving Test” to “Neutral Test”

automatically. Next touch the “Test” on/off button to start testing your servos. The “Neutral test” is good for finding the neutral position of a servo horn.

AIRPLANE

- Touch the [Servo Monitor] button in the Linkage Menu to call the setup screen shown below.

GLIDER

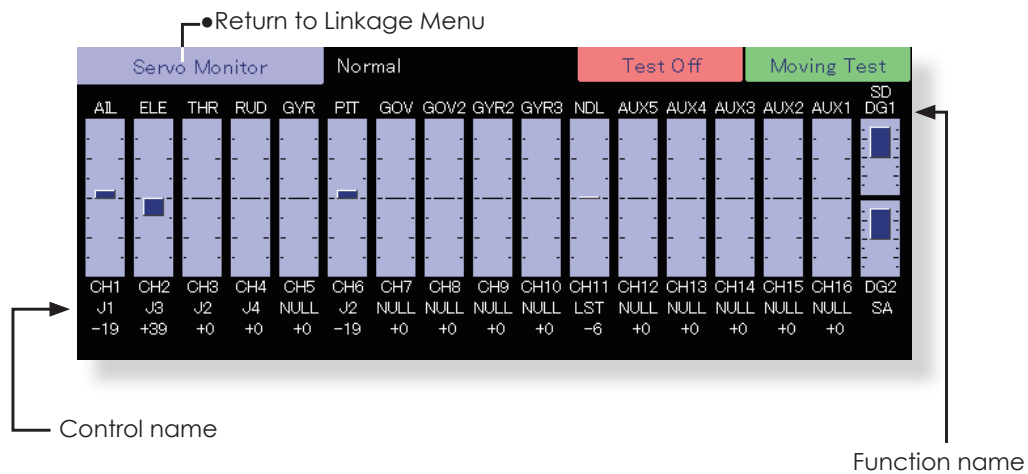

Servo test operation

1. Select a test mode ([Moving] or [Neutral]).
[Repeat]: Each servo repeats operation.
[Neutral]: Each servo is locked in the neutral position.
2. When the [Test Off] button is touched, testing begins in the selected mode.

⚠ WARNING

- ⊘ Don't set a servo test mode when the drive motor is connected and the engine was started.
 - Inadvertent rotation of the motor or acceleration of the engine is extremely dangerous.

HELICOPTER

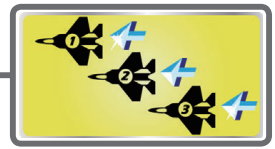

Model Select

The Model Selection function performs model addition, selection, deletion, copy, and model name setting.

This function is used to load the settings of the desired model into the T32MZ's memory.

The settings may be selected from either the transmitter's built-in memory or a microSD card. The name of the model stored in the transmitter and the microSD card may be changed. This can be very useful to tell different models settings apart. Each model name can be as long as 32 characters, and the model name always appears in the display screen.

- Touch the [Model Select] button in the Linkage Menu to call the setup screen shown below.

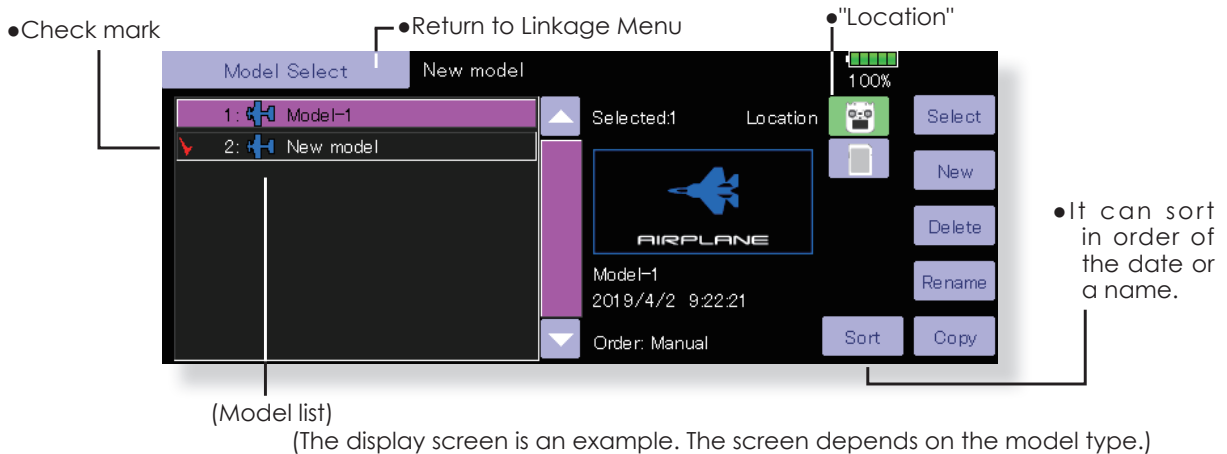

Model call

1. Touch the "Location" icon, and select the location to which the desired model is to be saved.
Transmitter icon: Transmitter memory
microSD card icon: microSD card
2. Touch the desired model in the model list.
3. Touch the [Select] button.
4. Touch [Yes] to call the model. (When you want to cancel model call, press [No].)

Model addition

1. Touch the [New] button.
2. Touch [Yes] to add the model. (When you want to cancel model addition, touch [No].)

*When a new model is added, the Model Type screen is automatically displayed. Check or change the model. If there are no changes, touch the Model Type icons.

*The added model is displayed in the model list.

*When Model addition, a link with a receiver is required. When not relinking, a new model can't use telemetry.

Model deletion

1. Touch the "Location" icon or the model you want to delete in the model list. (The model currently selected cannot be deleted.)
2. Touch the [Delete] button.
3. Touch [Yes]. (When you want to stop model deletion, touch [No].)

The Copy function is used to copy one set of model data into a second memory within the transmitter and the microSD card. It may be used for getting a head-start on setting up models with almost the same settings (only differences need to be modified, instead of entering the complete model from scratch). Also, this function may be used to make a backup copy of a model setup before any changes are made.

Model name change

1. Select the model by touching the "Location" icon or the desired model in the model list.
2. When [Rename] is touched, a keyboard appears on the screen.
3. Enter the model name from this keyboard.
*Up to 32 characters can be input at the model name.

Model copy

1. Select a model to copy from the list.
2. Check mark is attached to the model and a "Copy" button is displayed on the right.
3. Touch the "Copy" button and touch the "Destination" button and select the copy storage destination. (Transmitter or microSD card)
4. Touch the center [Copy] button.
5. When [Yes] is touched, copying is executed. (When you want to cancel copying, touch [No].)

*If there is no model with the same name in the copy destination, the name of the copied model is saved. If there is a model of the same name, a number is added at the end of the model name and the model is copied. You can change the name later.

*When the model data is copied, the model date is reset to the date that the copy was done.

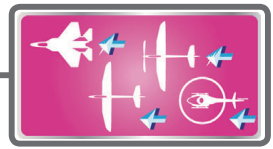

Model Type

This function allows you to select the model type from among airplane, helicopter, and glider.

Seven types of main wings and three types of tail wings are available for airplanes. Eight swash types are available for helicopters. Seven types of main wings and three types of tail wings are available for gliders. Functions and mixing necessary for each model type are set in advance at the factory.

Note: The Model Type function automatically selects the optimal output channels, control functions, and mixing functions for the chosen model type. When the Model Type Selection is accessed, all of settings in the active model are cleared. Be sure that you don't mind losing this data, or back it up to memory using the copying functions.

AIRPLANE

- Touch the [Model Type] button in the Linkage Menu to call the setup screen shown below.

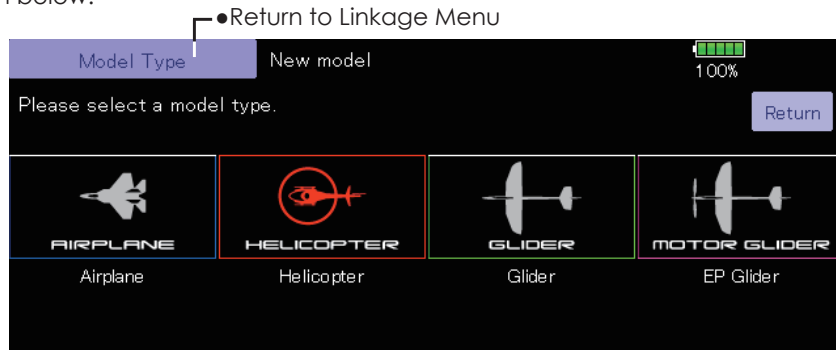

(The display screen is an example. The screen depends on the model type.)

GLIDER

Model type selection

1. Set the Model type, Wing type, Tail type, or Swash type by using the appropriate button.
2. Set the type you choose by touching [Yes] at the confirmation screen. (When you want to cancel model type selection, touch [No].)

Date changes after a swash type change

Data that has been set may change if the swash type of your helicopter is changed.

(Refer to the following table) When data is changed the [swash setting] screen is initialized.

Before	After	Data taking over
H-1, H-2, HE3, HR3, HN3, H-3	H-1, H-2, HE3, HR3, HN3, H-3	OK
H-4, H-4X	H-4, H-4X	OK
H-1, H-2, HE3, HR3, HN3, H-3	H-4, H-4X	NG
H-4, H-4X	H-1, H-2, HE3, HR3, HN3, H-3	NG

HELICOPTER

- When a data change will occur, the confirmation screen of data initialization menu will be displayed.
- A push on [yes] will initialize data and allow changes.
A push on [no] will stop data changes.

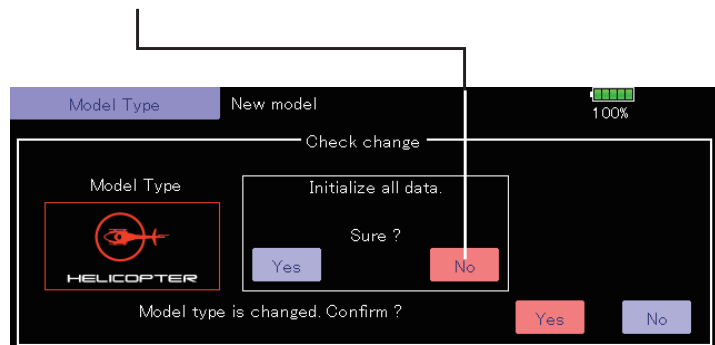

• Model type selection

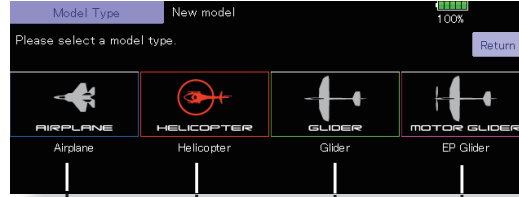

Model type
Select the model type from among airplane, helicopter, glider, and motor glider.

(Airplane, glider)

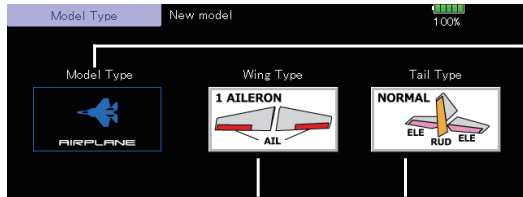

(Helicopter)

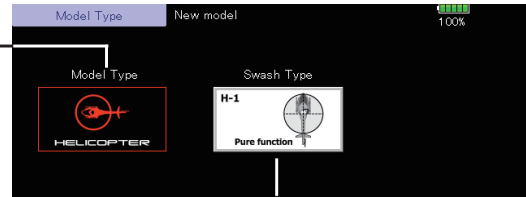

AIRPLANE

• Wing type selection (1/2)

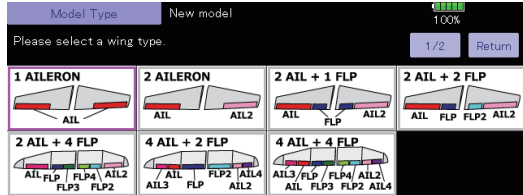

• Swash type selection

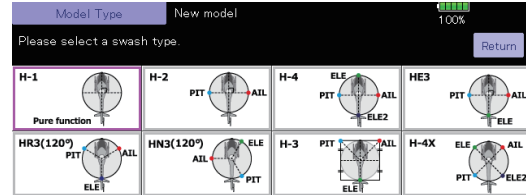

• Wing type selection (2/2)

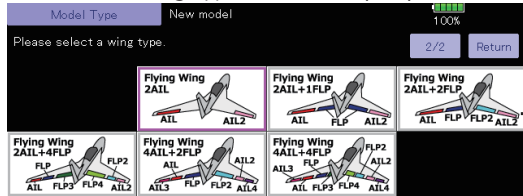

Helicopter swash type
Select from among H-1, H-2, H-4, HE3, HR3, HN3, H-3, and H-4X.

GLIDER

• Rudder type selection

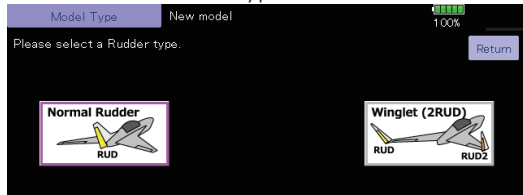

• Tail type selection

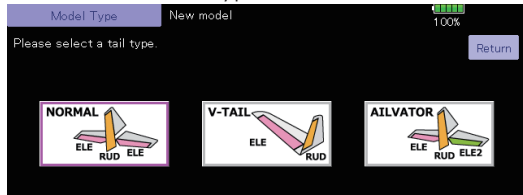

Wing type (1/2) (Normal)
Select from among :
1 aileron, 2 ailerons, 2 ailerons + 1 flap,
2 ailerons + 2 flaps, 2 ailerons + 4flaps,
4 ailerons + 2 flaps, 4 ailerons + 4 flaps.

Wing type (2/2) (Tail-less wing)
Selection from among:
2 ailerons, 2 ailerons + 1 flap,
2 ailerons + 2 flaps, 2 ailerons + 4 flaps,
4 ailerons + 2 flaps, 4 ailerons + 4 flaps.
*For Tail-less wing, the rudder type can be selected from normal rudder and winglet.

Tail type
Select from normal, V-tail, and elevator.

HELICOPTER



Picture A picture on the home screen can be set for each model. (Simplifies identification of the model data during screen operation.)

A photograph of the model taken with a digital camera or other file can be pasted as the screen display data for each model. This is convenient in identifying models with the same model name.

*The picture files which can be displayed on the screen are size 168 x 80 pixels, file type .bmp (bit map picture) and JPEG files. If a file larger than 168x80 is used, the picture displayed will be reduced. A larger file than 640x480 pixels cannot be used.

- Touch the [Picture] button in the Linkage Menu to call the setup screen shown below.

When a picture is pasted, it is displayed as a screen image in the following screens:

- Model Select screen
- Home screen
- Startup screen

AIRPLANE

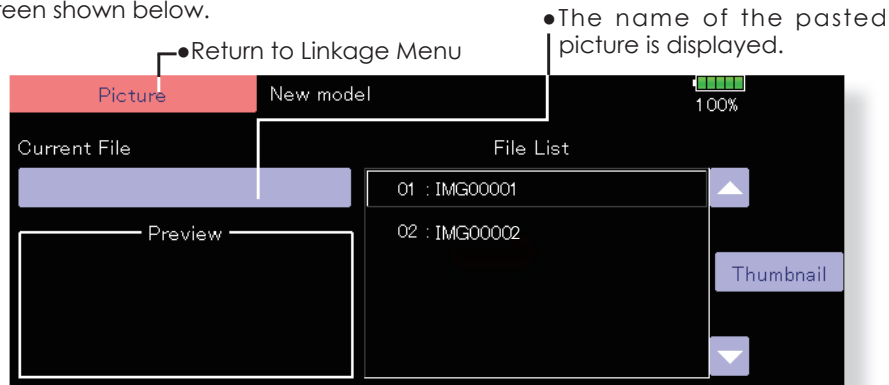

GLIDER

Pasting a picture

*Picture data is set to the model memory currently in use.

*You can choose to use a picture that is saved in these places: T32MZ, microSD card.

1. Select the picture from the file list by touching the desired picture data.

*Before selection, touch the scroll button at the top or bottom of the Thumbnail and confirm the contents of the picture to be saved by the preview screen.

2. To paste the picture, touch [Yes]. (When you want to cancel pasting, touch [No].)

HELICOPTER

Copy/Delete/Release/Rename of picture

1. Select the picture from the [Thumbnail] by touching the desired picture data.

2. To paste the picture, touch this screen is displayed.
3. Copy (T32MZ/microSD card), Delete, Release, Rename or selection.

*Release : It loses from Current File.

Delete : Picture data is deleted.

*Select the picture from the thumbnail, memory card or 32MZ icons you wish to copy for that particular model. Press Enter and exit out to the home page.

4. Next, select [Yes] or [No]. Select Rename to name the picture of your choice with the appeared keyboard. When finished, press Return.

[Important]

Before reading data from the PC, insert the microSD card into the transmitter and turn on the power. The following folders are automatically written. To read a file from the PC, copy the file to a folder by file type.

•BMP: Picture file	•WAV: Audio file
•WMA: Music file	•MODEL: Model data

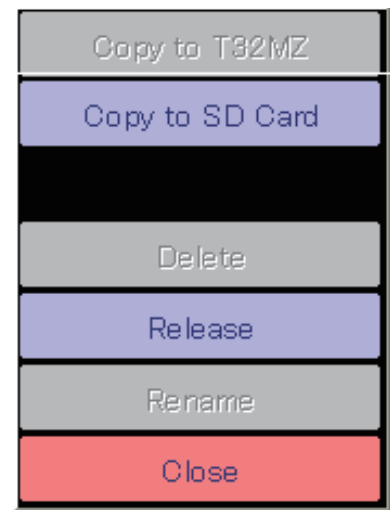

Sound

Sound recording and playback.



Sounds recorded with the microphone built into the transmitter or any audio files (.wav) can be set to the power switch or any preset switch that you choose.

- *Only a .wav file saved in the same storage place (T32MZ, microSD card) as the current model can be chosen.
- *The maximum recording time from the microphone is 3 seconds. Twenty-four audio files can be saved.
- *The only audio file type which can be recorded is .wav. Only the sounds recorded with the built-in microphone or an audio file saved from your PC to an microSD card can be played back.

Setup screens number 3 to 24 can be individually assigned to audio file switches, etc. The playback files can be switched each time the same switch is operated. This can be used when playing back the name of maneuvers, etc.

- Touch the [Sound] button in the Linkage Menu to call the setup screen shown below.

[Sound starting]

- #1: When transmitter power switch turned on
- #2: When transmitter power switch turned off
- #3~24: Switch can be set.

[Important]

Before reading data from a PC, insert the microSD card into the transmitter and turn on the power. The following folders are automatically written. When reading a file from the PC, copy it to a folder by file type.

- BMP: Picture file
- WAV: Audio file
- WMA: Music file
- MODEL: Model data

AIRPLANE

GLIDER

HELICOPTER

•Return to Linkage Menu

No	Switch	Mode	File	Rec	No	Switch	Mode	File	Rec
1	Start up			🔍	7	OFF	→		🔍
2	Power off			🔍	8	OFF	→		🔍
3	OFF	→		🔍	9	OFF	→		🔍
4	OFF	→		🔍	10	OFF	→		🔍
5	OFF	→		🔍	11	OFF	→		🔍
6	OFF	→		🔍	12	OFF	→		🔍

(Saved sound file)

- Touch the file button Copy/Delete/Entry/Release/Rename is made. It is the same procedure as the picture of the preceding clause.

Voice Recording

1. Touch any REC button to call up the SOUND RECORDER screen.
2. Touch the REC button to start recording. (Recording time: 3 seconds)
3. Record your voice as you are facing the transmitter's microphone.
 - *Speak loudly and clearly.

4. To finish, press "CLOSE". Also sound files created by your PC may be played back by assigned switches. (File types; .wav file only)
 - *A voice file is saved automatically to the location of the model you are currently using. Whether in the transmitter, microSD card. A file name is displayed on the file button corresponding to a recording button.

Assignment of audio files to switches

*Audio files can be saved beforehand.

1. Touch the file button of the number you want to set. A list of the files stored is displayed.
2. Select the audio file you want to play back from the list of audio files.

*Since the audio files are played back when the audio file names in the list are touched, the file contents can be checked before assignment.

3. Touch the [File] button to assign the files.
4. (Switches are also selected for number 3~24.)
Touch the [NULL] button to call the switch select screen.



5. Select the switch and its ON direction at the switch select screen.
(For a detailed description of the selection method, see "switch setting method" at the back of this manual.)

AIRPLANE

GLIDER

HELICOPTER

Mode button

-  Playing back registered file only once
-  Playing back registered file repeatedly
-  Sequentially playing back registered file each time operated by 1 switch

No	Switch	Mode	File	Rec	No	Switch	Mode	File	Rec
1	Start up		Sound		7				
2	Power off				8				
3	SG				9				
4					10				
5					11				
6					12				

Sequentially playing back registered file each time operated by 1 switch

This is used when calling the order of maneuvers, etc.

[Setting method]

1. After selecting the switch, press the [→] button. The button display thereafter is switched as shown in the screen above.
2. Assign the audio files in the order in which you want to play them back.

The audio files are played back each time the switch selected by the above setting is turned on.



System Type selection

The T32MZ is for 2.4GHz only. The system can be changed from among 5 choices: FASSTest 18CH, FASSTest 12CH, FASST MULTI, FASST 7CH, S-FHSS, T-FHSS. Select the system matched to the type of receiver you are using.

*Even if it changes a system type, other model data is not reset.

*If a system type is changed in the case of a helicopter, It can choose out of two channel orders.

[Yes] : Selection sets the channel order suitable for system type. (We recommend here.)

[No] : The present channel order is maintained.

*All control surfaces should be checked for the correct operating directions and operating smoothness before flying the model.

*Analog servos cannot be used with the R7108SB in the FASSTest 12CH mode.

Receiver linking

The receiver will only be controlled (without being affected by other transmitters) by the transmitter it is linked to. When using a receiver other than one purchased as a set, linking is necessary.

Moreover, a re-link is required when a new model is added by model selection, and the time of system type change.

Dual receiver function (only FASSTest 18CH mode)

Dual receivers can be linked with the T32MZ. Two receivers are recognized individually by ID numbers. For example, in R7108SB, CH output setting function is used, by setting the first as "1-8CH", and setting the second as "9-16CH", two sets of receivers can be used as a set in the

- Touch the [System Type] button in the Linkage Menu to call the setup screen shown below.

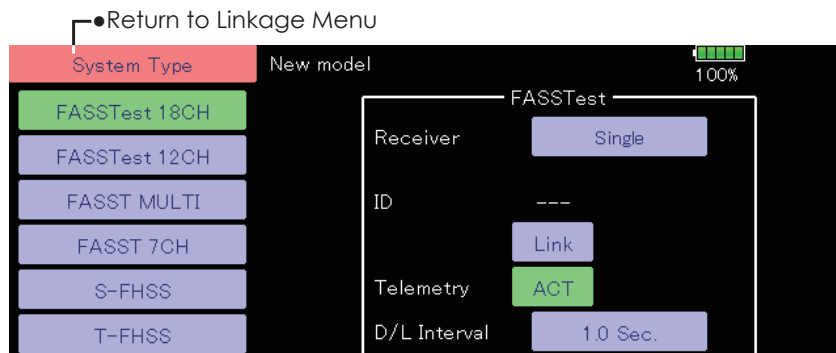

model, allowing you 16 channels. If a dual receiver function is used, the following function can set up individually.

- Battery fail-safe voltage setup

A telemetry function cannot be used for the 2nd receiver. The voltage and Ext voltage of a 2nd receiver cannot be known with a transmitter.

Telemetry function (only FASSTest mode)

To use the telemetry function, set "Telemetry" to "ON".

D/L Interval (only FASSTest mode)

When a telemetry function is enabled, the receiving interval (down-link interval) of sensor data can be changed.

If a D/L interval is increased, the response of the sensor data display becomes slower, but stick response will improve.

Battery fail-safe voltage setup (FASSTest/T-FHSS mode)

The voltage which battery fail-safe activates, can be set when you link. (3.5-8.4 V) The receiver memorizes the setting as it was at link.

Suggested setting voltages are as follows.

- 4 cells NiCd or NiMH (Normal: 4.8 V) = 3.8 V
- 2 cells LiFe (Normal: 6.6 V) = 6.0 ~ 6.2 V
- 2 cells LiPo (Normal: 7.4 V) = 7.2 ~ 7.4 V

It is a rough reference value.

Since it changes with servos carried in the condition and the model of a battery, please set to your own model in a battery consumption current.

AIRPLANE

GLIDER

HELICOPTER

Linking method (T32MZ ↔ R7108SB)

1. Bring the receiver to be linked to within 50 cm of the transmitter.
2. Press the [Link] button in the [Link] box of [System Type].
3. The transmitter emits a chime sound and enters the link mode.
4. The receiver power is immediately turned on. About 2 seconds after the power is turned on the receiver enters the linking state.
(Receiver linking time is about 1 second)
5. If linking is successful, the receiver LED changes from red to green, the link mode ends, and the receiver ID code is displayed.
6. If linking fails, an error message is displayed. Bring the transmitter closer to the receiver and repeat the procedure above from step 2.

- * Do not perform the linking operation when the drive motor is connected or the engine is running.
- * When you use two receivers, please be sure to setup a "primary" and "secondary" in the "dual" mode.
- * Since two sets of receivers cannot be individually recognized without using a "primary" and "secondary" setup, it is impossible to receive telemetry data correctly.
- * You must link one receiver at a time. If both power supplies to the receivers are switched on simultaneously, data is received incorrectly by the transmitter.
- * A telemetry function cannot be used for the 2nd receiver.
- * You cannot link three sets of receivers.
- * Link is required when a system type is changed.
- * Link is required when a new model is made from a model selection.

- Touch the [Link] button in the System Type Menu to call the setup screen shown below.
- Battery fail-safe voltage setup (only FASSTest/T-FHSS mode)

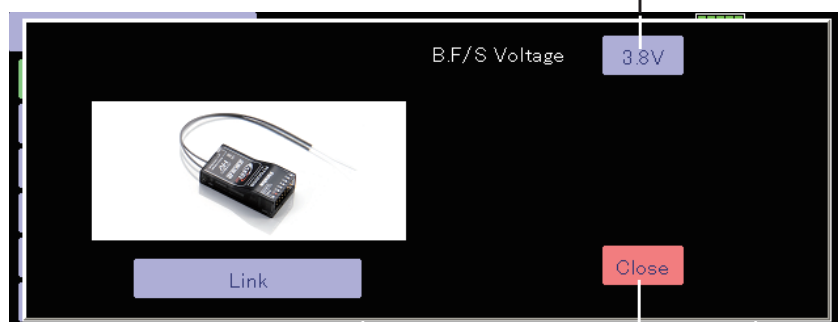

- Return to System Type Menu

⚠ WARNING

- ⊘ Do not perform the linking operation when the drive motor is connected and the engine was started.
- Inadvertent rotation of the motor or acceleration of the engine is extremely dangerous.

- ❗ Once the link operation is complete, please check that your receiver can be operated with the linked transmitter.

- ❗ Check operation sufficiently before flying after linking.

- If the same receiver is sending in the vicinity, there is the danger that the transmitter may be linked with that receiver.

⚠ CAUTION

- ❗ Always turn on the transmitter power after linking is complete.

- ❗ When pairing with the transmitter, be sure that a previously linked transmitter is not transmitting

The example for choosing System Type

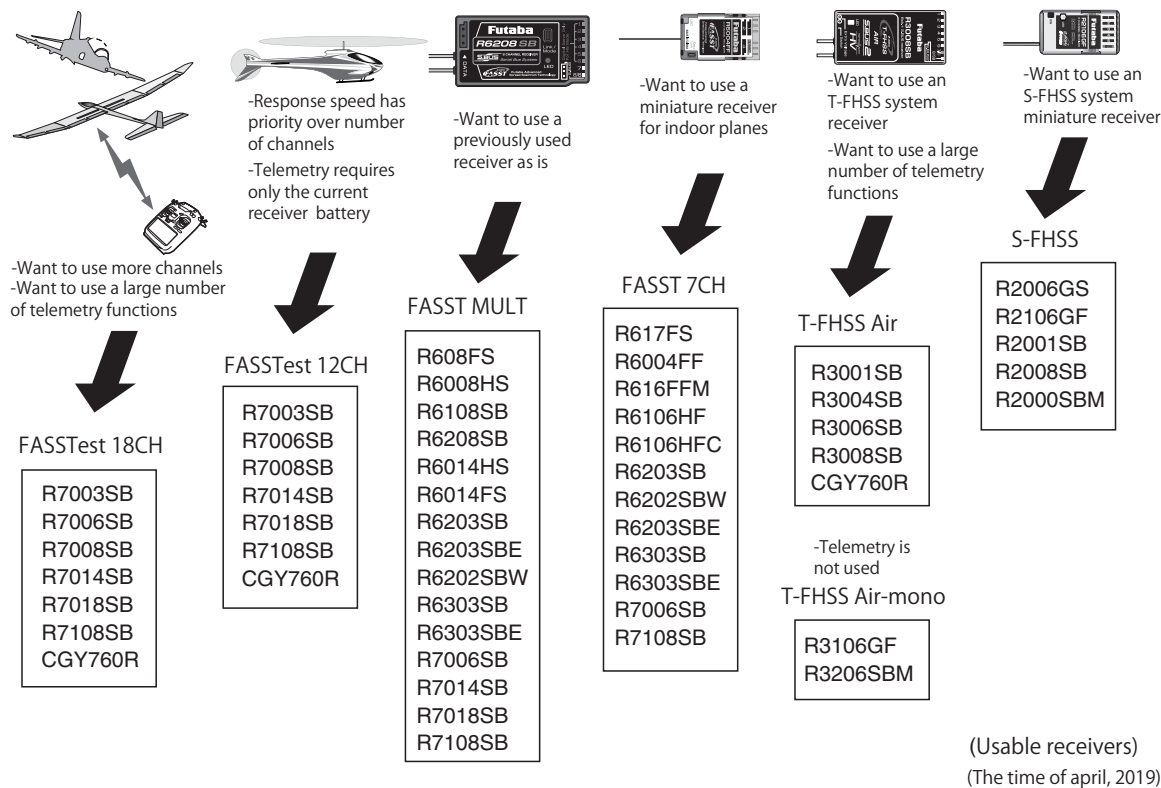

System type

- **FASSTest 18CH** --- FASSTest system receiver mode. Applicable with the telemetry sensor unit. Up to 18 channels (linear 16+ON/OFF2) can be used.
- **FASSTest 12CH** --- FASSTest system receiver mode. Applicable with receiver voltage display. Up to 12 channels (linear10+ON/OFF2) can be used. Telemetry Sensor cannot be used, but the response speed is faster than that of the 18CH mode.
 - Analog servos cannot be used with the R7108SB in the FASSTest 12CH mode.
- **FASST MULTI** --- FASST-MULTI system receiver mode. Up to 18 channels (linear 16+ON/OFF2) can be used.
- **FASST 7CH** --- FASST-7CH system receiver mode. Up to 7 channels can be used.
- **T-FHSS Air** --- T-FHSS system receiver mode. Applicable with the telemetry sensor unit. Up to 18 channels (linear 16+ON/OFF2) can be used.
- **S-FHSS** --- S-FHSS system receiver mode. Up to 8 channels can be used.

Receiver link method in FASST and S-FHSS

If the receiver of FASST and S-FHSS is used, the methods of a link differ.

1. Bring the transmitter and the receiver close to each other, within 20 inches (half meter).
2. Turn on the transmitter.
3. Turn on the receiver.
4. Press and hold the Link switch more than two (2) seconds. When the link is complete, the LED in the receiver changes to solid green. When the ID cannot be read due to the surrounding environment, try reading it with the transmitter and receiver antennas touched.

*Follow the manual of the receiver to be used.
Moreover, carry out an operating check.

In case of **FASST/S-FHSS**, a **Link button** of the receiver is pressed for a link.



AIRPLANE

GLIDER

HELICOPTER



Function

Channel assignment for each function can be changed to suit your needs.

When you select model and wing (swash) types, you will find that the optimized combinations of servo output channels and functions have been already preset. If you would like, on the function-setting screen of the linkage menu, you can freely change combinations of servo output channels, functions (aileron, elevator, etc), and input controllers (sticks, switches, trim levers and trim switches). You can also assign the same function to multiple servo output channels such as assigning elevator function to CH2 and CH3.

- Touch the [Function] button in the Linkage Menu to call the setup screen shown below.

DG1, DG2 (switch channels)

These two channels can be used as switch (On/Off) channels. You can freely change combinations between servo output channels and input controllers (sticks, switches, trim levers and trim switches).

Channel restrictions by a System Type

FASSTest 18CH/T-FHSS	---	16 CH+2 Switch
FASSTest 12CH	---	10 CH+2 Switch
FASST MULTI	---	16 CH+2 Switch
FASST 7CH	---	7 CH
S-FHSS	---	8 CH

AIRPLANE

GLIDER

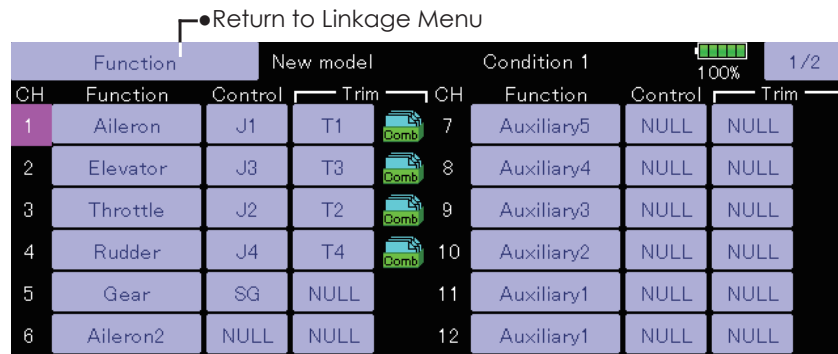

(The display screen is an example. The screen depends on the model type.)

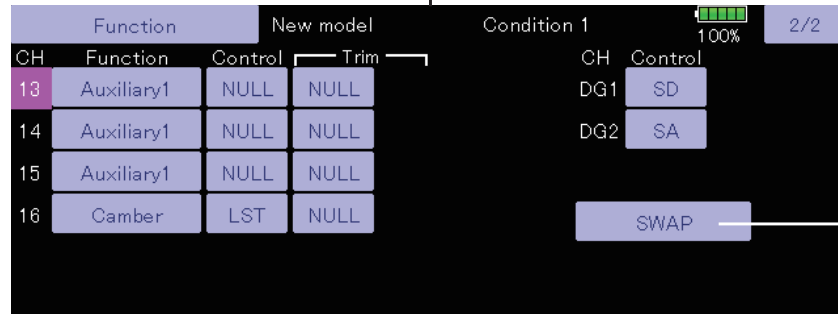

Function change

1. Touch the function button of the channel you want to change to call the function list.
2. Select the function you want to change.
3. Touch [Yes]. The display returns to the original screen. (When you want to cancel function change, touch [No].)

*Multiple (MPDX-1) channels can be assigned to 1 function.

*Multiprop1, 2 is an optional object for Multiprop decoders.

<CH which can be Multiprop set up.>

FASSTest 18CH/T-FHSS	---	1-12CH
FASSTest 12CH	---	not set
FASST MULTI	---	11, 12CH
FASST 7CH	---	not set
T-FHSS, S-FHSS	---	not set

*Select PCM-G3 for operation mode of multi-prop MPDX-1.

Operation control change

1. Touch the control button of the channel you want to change. A control select screen (stick, switch, knob, trim lever, etc.) is displayed.
2. Select the control you want to operate.
3. Touch [Close]. The display returns to the preceding screen.

*The same control can be assigned to multiple channels.

HELICOPTER

SWAP

If [SWAP] is pushed, it will call up the following screen. You can easily change two separate functions, keeping the data that was set for each channel.

1. Select the (Trim) button for the two functions you selected to Swap to set up the trims appropriately.
2. If [OK] is pushed, two channels will interchange.

*It can choose only to two.

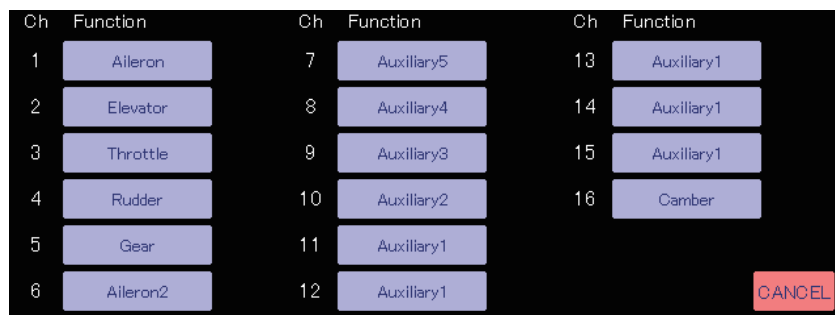

AIRPLANE

Trim change

1. Touch the trim button to call the trim setup screen.
2. The following items can be set at the trim setup screen.

- Hardware setting (Selection of switch, etc. which controls trim) (The select screen is selected by touching the [H/W Select] button.)
- Rate setting
- Operation step setting
- Trim mode setting
 - Normal mode: Normal trim (linear) operation
 - ATL mode: ATL operation mode. (Works at only one end of operation) Reverse is also possible.

CTRM mode: Maximum change near center by center trim operation (Does not change at end of the stick movement)

- Separate/combination mode: Trim data can be set to different flight conditions

Separate mode: Trim adjustment for each separate flight condition.

GLIDER

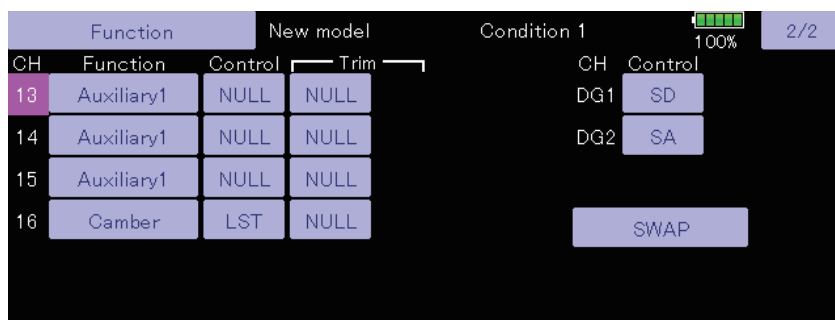

(The display screen is an example. The screen depends on the model type.)

HELICOPTER

Sub-Trim

Setting of neutral position of each servo.

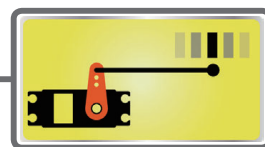

The Sub-Trim function is used to set the servo neutral position, and may be used to make fine adjustments to the control surface after linkages and pushrods are hooked up. When you begin to set up a model, be sure that the digital trims are set to their center position.

AIRPLANE

- Touch the [Sub Trim] button in the Linkage Menu to call the setup screen shown below.

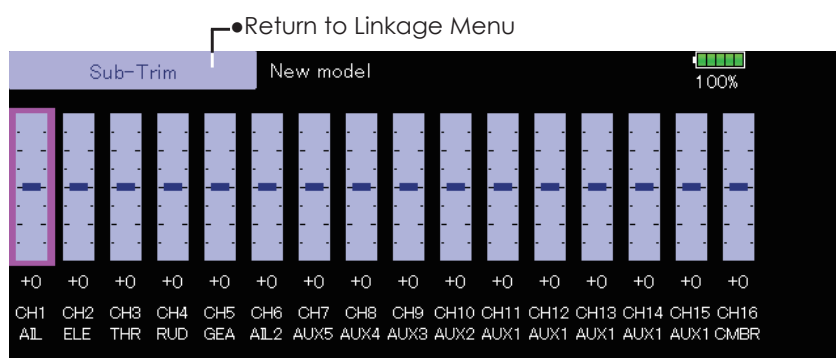

(The display screen is an example. The screen depends on the model type.)

GLIDER

Sub trim adjustment

1. Touch the trim display part of the channel you want to adjust.
Adjustment buttons appears on the Sub Trim menu screen.
2. Use the adjustment buttons to adjust the sub trim.
 - Initial value: 0
 - Adjustment range: -240~+240 (steps)
 - *See above
3. Repeat this step for each channel.

HELICOPTER

Servo Reverse

Use to reverse the servo throw direction.



Servo Reverse changes the direction of an individual servo's response to a control stick movement.

For CCPM helicopters, be sure to read the section on Swash AFR before reversing any servos. With CCPM helicopters, always complete your servo reversing prior to any other programming. If you use pre-built Airplane/Glider functions that control multiple servos, it may be confusing to tell whether the servo needs to be reversed or a setting in the function needs to be reversed. See the instructions for each specialized function for further details. Always check servo direction prior to every flight as an additional precaution to confirm proper model memory, hook ups, and radio function.

⚠ WARNING

- ! Before a flight, always check that your models servo operation, the direction of control surfaces, and switch setup are correct.
- ! Default setting of the motor channel is always reverse.

- Touch the [Servo Reverse] button in the Linkage Menu to call the setup screen shown below.

Return to Linkage Menu

Servo Reverse			New model			100%		
CH	Function	Setting	CH	Function	Setting	CH	Function	Setting
1	Aileron	NORM	7	Auxiliary5	NORM	13	Auxiliary1	NORM
2	Elevator	NORM	8	Auxiliary4	NORM	14	Auxiliary1	NORM
3	Throttle	NORM	9	Auxiliary3	NORM	15	Auxiliary1	NORM
4	Rudder	NORM	10	Auxiliary2	NORM	16	Camber	NORM
5	Gear	NORM	11	Auxiliary1	NORM		DG1	NORM
6	Aileron2	NORM	12	Auxiliary1	NORM		DG2	NORM

(The display screen is an example. The screen depends on the model type.)

Servo reversing procedure

After setting up a new model, be sure to define all special menus. Be sure that all servos are plugged into the proper receiver channels. Now, determine whether you need to reverse any channels by moving each stick and observing the corresponding movement in the model's controls.

1. Touch the desired channel's setting button to choose the proper direction for the servo.
2. Touch "Yes" in the next screen.
3. Repeat for each servo needing reversal.

When done, touch "Servo Reverse" to return to the Linkage Menu.

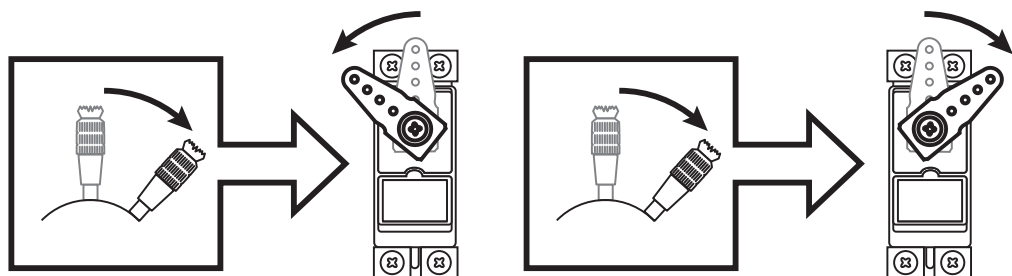

AIRPLANE

GLIDER

HELICOPTER



Fail Safe

Sets the servos operating position when transmitter signals can no longer be received or when the receiver battery voltage drops.

The Failsafe function is used to set up positions that the servos will move to in the case of radio interference. Defines servo position when signals are lost and when receiver battery voltage becomes low.

You may set either of two positions for each channel: Hold, where the servo maintains its last commanded position, or fail safe, where each servo moves to a predetermined position. You may choose either mode for each channel.

The T32MZ system also provides you with an advanced battery monitoring function that warns you when the receiver battery has only a little power remaining. In this case, each servo is moved to the defined failsafe position. The battery failsafe may be released by operating a predefined control on the transmitter (default is throttle). **Do not continue to fly, land as soon as possible.** Remember, if the predefined control suddenly moves to

- Touch the [Fail Safe] button in the Linkage Menu to call the setup screen shown below.

a position you did not command, land at once and check your receiver battery.

Do not continue to fly, land as soon as possible. Defines servo position when signals are lost and when receiver battery voltage becomes low.

⚠ WARNING

❗ For safety, always set the fail safe functions.

- Especially set the throttle channel fail safe function so that the servo moves to the maximum slow side for airplanes and to the slow side from the hovering position for helicopters. Crashing of the model at full high when normal radio waves cannot be received due to interference, etc., is very dangerous.
- If fail safe is reset by throttle stick movement, the fail safe may be mistaken as an engine malfunction and will be reset at low throttle and the model will continue to fly. If you have any doubts, immediately land.

AIRPLANE

GLIDER

HELICOPTER

•Return to Linkage Menu

Fail Safe			New model		100%		Batt. F/S	OFF	1/2
CH	Function	Mode	B.F/S	F/S Posi.	CH	Function	Release Mode	B.F/S	F/S Posi.
1	Aileron	Hold	OFF		7	Auxiliary5	Hold	OFF	
2	Elevator	Hold	OFF		8	Auxiliary4	Hold	OFF	
3	Throttle	Hold	OFF		9	Auxiliary3	Hold	OFF	
4	Rudder	Hold	OFF		10	Auxiliary2	Hold	OFF	
5	Gear	Hold	OFF		11	Auxiliary1	Hold	OFF	
6	Aileron2	Hold	OFF		12	Auxiliary1	Hold	OFF	

•To <Switch> screen

(The display screen is an example. The screen depends on the model type.)

Fail safe setting procedure

Decide which channels you want to go to preset positions, and which ones you want to maintain their last commanded position. To select the fail safe mode you wish to set, use the F/S button. This button toggles between the two modes. (Hold, F/S)

F/S mode setting:

1. Touch the F/S button of the channel you want to set, and set that channel to the [F/S] mode.
2. Hold the corresponding stick, control, slider, or other control in the position you want the servo to move to when the fail safe function is activated, and touch the F/S position button. That position is displayed in percentage.

*When you want to return that channel to the Hold mode, touch the [F/S] button again.

Battery fail safe setting procedure

To select the B.F/S mode, touch the [B.F/S] button. Each time the button is touched, it toggles between [OFF] and [B.F/S].

B.F/S setting:

1. Touch the [B.F/S] button of the desired channel to set it to the B.F/S mode.
 2. Hold the corresponding stick, VR, slider, or other control in the position you want the servo to move to when the battery fail safe function is activated, and touch the F/S position button. This position is displayed in percentage.
- *When you want to return that channel to OFF, touch the [B.F/S] button again.

Battery Fail safe Release Function

This function releases the predefined control from its held position after indicating that your receiver battery is low.

1. Enter the control setting screen by touching the Battery F/S Release button. Now, you may choose whether moving the throttle resets the condition, or select a stick or switch to deactivate it. To set a desired throttle release position, move the throttle stick to the point at which you wish the B.F/S to be released.

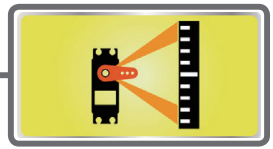

End Point (ATV)

Sets the travel, limit point, and speed of each servo.

The End Point function adjusts the left and right servo throws, generates differential throws, and will correct improper linkage settings.

The travel rate (normal full stick movement at high rates) can be varied from 30% to 140% in each direction on channels 1 to 16. Also, the limit point (how far the servo travels when a mix is involved) where servo throw stops may be varied from 0% to 155%.

Note: The indicators on the screen display actual servo throw of the each channel. The center position of the indicator is based on the Sub-Trim settings. Therefore the Sub-Trim adjustment changes the Limit point display of the indicator. The Servo Speed setting is used to set the servo delay for each channel, from channel 1 to channel 16. The system uses the programmed speed (delay) to slow down servo position changes. The Servo Speed setting can be varied from 0 to 27 in each channel.

- Touch the [End Point (ATV)] button in the Linkage Menu to call the setup screen shown below.

Return to Linkage Menu

CH	Function	Limit	Travel	← ↑ ↻	↻ ↓ →	Travel	Limit	Speed
1	Aileron	135%	100%			100%	135%	0
2	Elevator	135%	100%			100%	135%	0
3	Throttle	135%	100%			100%	135%	0
4	Rudder	135%	100%			100%	135%	0
5	Gear	135%	100%			100%	135%	0
6	Aileron2	135%	100%			100%	135%	0

(The display screen is an example. The screen depends on the model type.)

Servo travel adjustment

1. Touch the travel button of the channel you want to set. Adjustment buttons appear on the screen.
2. Use these buttons to adjust the rate.
 - Initial value: 100%
 - Adjustment range: 30%~140%
3. Repeat the procedure above for each rate.

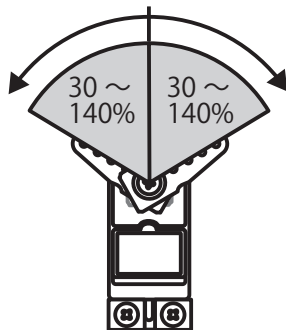

Limit point adjustment

1. Touch the limit button of the channel you want to set.
2. Use the adjustment buttons to adjust the limit point.
 - Initial value: 135%
 - Adjustment range: 0%~155%
3. Repeat this procedure for each limit point.

Servo speed setting

1. Touch the Speed button of the channel you want to set.
2. Use the adjustment buttons to adjust the servo speed.
 - Initial value: 0
 - Adjustment range: 0~27 (steps)
3. Repeat this procedure for each channel.

To close this screen, touch the [End Point (ATV)] button.

Throttle Cut

Stops the engine safely and easily. (Airplane and helicopter only)



Throttle cut provides an easy way to stop the engine, by flipping a switch with the throttle stick at idle. The action is not functional at high throttle to avoid accidental dead sticks. The switch's location and direction must be chosen, as it defaults to NULL.

Note: When conditions are set, at Throttle cut setup can be performed for each condition. Throttle cut can only be activated in a specific condition if you have selected and set up this function within the condition. When using throttle cut in a specific condition, and ON or active. If you change to another condition, throttle cut is canceled and no longer active in the first condition, as long as the second condition does not have throttle cut active.

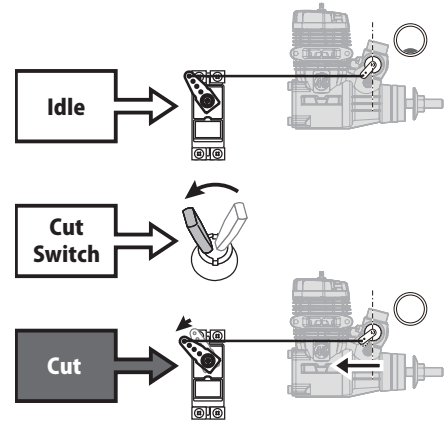

AIRPLANE

- Touch the [Throttle Cut] button in the Linkage Menu to call the setup screen shown below.

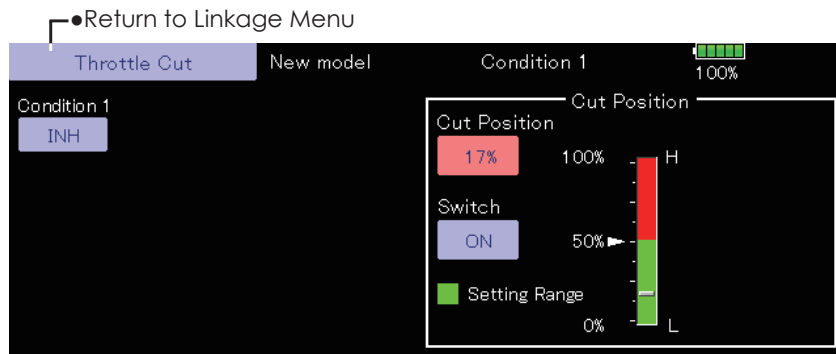

(The display screen is an example. The screen depends on the model type.)

Throttle cut setting procedure

1. To set up throttle cut in conditions, select the condition number and touch the "INH" button.
2. Throttle cut function switch setting:
Touch the "NULL" button to call the <Switch> screen, and then select the switch and its ON direction.
(For a detailed description of the selection method, see [Switch Setting Method] at the back of this manual.)
3. Throttle cut position setting:

Set the throttle stick to maximum slow, and touch the cut Position button. Adjustment buttons appear. At the same time, the numerical value of the current maximum slow side is displayed at "Cut Position".

Use the adjustment buttons to adjust the servo travel when the throttle cut function is activated.

- Initial value: 17%
- Adjustment range: 0%~50%

*With throttle stick at idle, adjust the rate until the engine consistently shuts off, but throttle linkage is not binding. When finished, touch the "Throttle Cut" button to exit.

To exit the setting, touch the [Throttle Cut] button.

HELICOPTER

Idle Down

Lowers the engine idling speed. (Airplane and helicopter only)



The idle down function lowers the engines idle by flipping a switch with the throttle stick at idle. The action is not functional at high throttle to avoid accidental dead sticks. The switch's location and direction must be chosen, as it defaults to NULL.

AIRPLANE

- Touch the [Idle Down] button in the Linkage Menu to call the setup screen shown below.

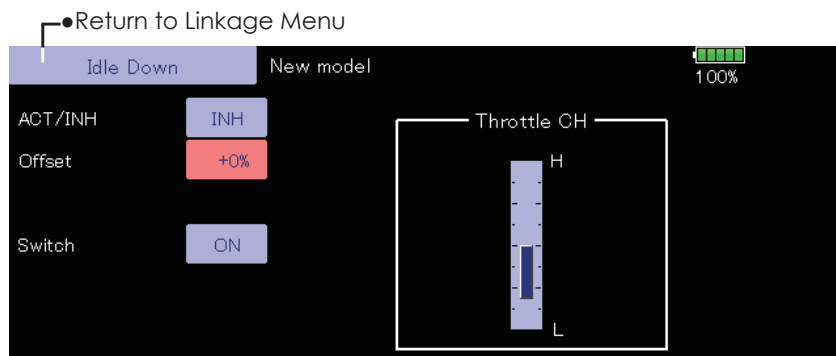

(The display screen is an example. The screen depends on the model type.)

Idle down setting procedure

1. Touch the "INH" button to activate the idle down function.
2. Idle down function switch setting:
Touch the "NULL" button to call the <Switch> screen, and then select the switch and its ON direction.
(For a detailed description of the selection method, see [Switch Setting Method] at the back of this manual.)
3. Offset rate setting:
Touch the offset rate button. Adjustment buttons appear on the screen.
Use these buttons to adjust the offset rate.
 - Initial value: 0%
 - Adjustment range: -100%~100%*(-)becomes an idle up.

To exit the setting, touch the [Idle Down] button.

HELICOPTER

Swash Ring

Limits the swash travel within a fixed range to prevent linkage damage (Helicopter only)

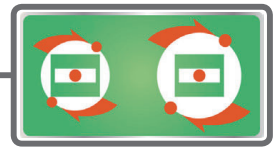

This function limits the travel of the swash plate to prevent linkage damage as the aileron and elevator operation is used. It is useful for 3D heli setting.

- Touch the [Swash Ring] button in the Linkage Menu to call the setup screen shown below.

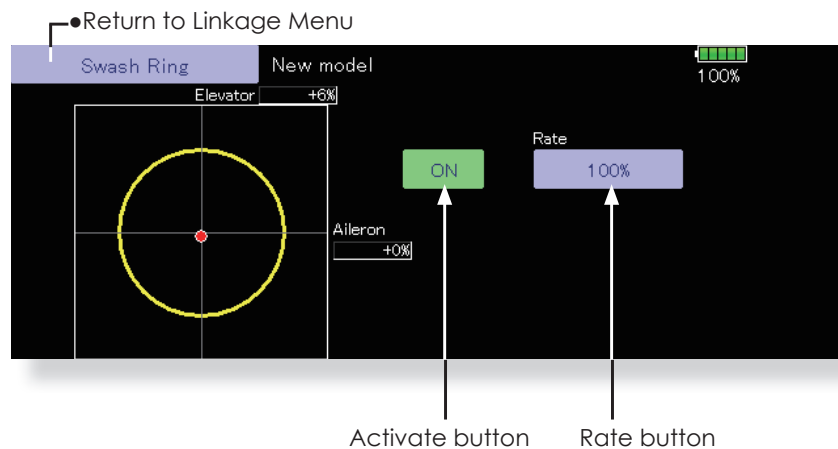

Swash ring setting procedure

1. Push the Swash ring button on the linkage menu.
2. Push ACT/INH button to activate.
*The movement area monitor shows the current aileron and elevator values and limit ranges by the yellow circle.
3. Adjust the rate to the maximum amount of swash plate decline.
*The swash movement is limited within the circle.
Adjustment range: 50-200%.



Swash

Swash operation linkage correction function
(This swash setup screen does not appear for swash type H-1.)

Neutral Point

On your linkages, if the servo horn deviates from perpendicular at neutral, the linkage compensation functions may not work effectively. This neutral point setting reads the linkage compensation neutral position. However, this adjustment only changes the reference point of the compensation function on the swash details screen and does not affect the neutral position of other functions.

*Before using the compensation function, set the neutral point.

Swash AFR

The swash AFR function adjusts (increases/decreases/reverse) the rate (travel) of the aileron, elevator, and pitch functions.

Mixing Rate

(Normally, the default value is used.)

This mixing rate is used for minor correction to the swash plate so that it moves in the correct direction for aileron, elevator, and pitch operation.

Compensation mixing is shown below.

*PIT → AIL/PIT → ELE/AIL → PIT/ELE → AIL/ELE → PIT

*Use the corresponding compensation mixing and adjust so that the swash plate moves in the correct direction.

Linkage Compensation

This compensation mixing is used to adjust for interference when the ailerons or elevators are operated when the throttle stick was in the low or high position.

Speed Compensation

This speed compensation function make adjustments for interference when the travel of each servo is different due to swash plate operation. For HR-3, it compensates the speed by dropping the operating speed of the aileron and pitch servos during elevator operation.

- Touch the [Swash] button in the Linkage Menu to call the setup screen shown below.

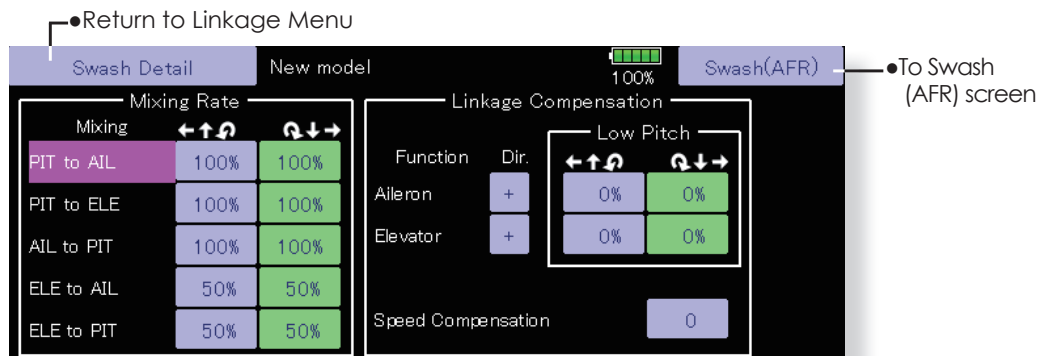

Neutral point setting procedure

*Becomes the compensation reference point.

*Adjusting the servo horn so that the neutral point position is near the 50% position makes the mixing amount small.

1. Hold the servo horn at a right angle to the linkage rod, and then touch the [Enter] button and read the actual neutral point.

*The neutral point is displayed on the screen.

After reading this neutral point, use other compensation functions to make further adjustments.

To exit the setting, touch the [Swash] button.

Swash AFR setting procedure

Adjust so that the specified operation amount is obtained by aileron, elevator, and pitch operation.

1. Touch the button of the AFR rate to be adjusted. Adjustment buttons appear on the screen.
2. Use the adjustment buttons to adjust the AFR rate.

Initial value: +50%

Adjustment range: -100%~+100%

+ or - the direction of operation changes.

To exit setting, touch the [Swash] button.

Mixing rate setting procedure

HR-3 is described as an example. The mixing applied in other swash modes is different, but the setting procedure is the same.

1. Set the throttle stick to the set neutral point. Adjust the length of the linkage rod so that the swash plate is horizontal at this position.

*A little adjustment using sub trim should be OK.

*Adjust so that pitch operation when the pitch curve is straight is maximum.

2. Adjust the AIL → PIT amount so there is no interference in the elevator or pitch direction when the aileron stick is moved to the left and right.

*Adjust the left and right sides separately.

3. Adjust the ELE → AIL and ELE → PIT amounts so there is not interference in the aileron or pitch direction when the elevator stick is moved up and down.

*Adjust the up and down sides separately.

4. Adjust the PIT → AIL and PIT → ELE amounts so that the swash plate is horizontal when the throttle stick is set to maximum slow and full high.

*Adjust the slow and high sides separately.

To exit setting, touch the [Swash Details] button.

Linkage correction setting procedure

*Set the linkage compensation after setting the mixing rate.

*This function compensates for elevator

interference by aileron operation or aileron interference by elevator operation at Low pitch and Hi pitch at collective pitch (HR3, etc.) control.

1. Set the throttle stick to the maximum slow position. Move the aileron stick to the left and right and adjust the aileron compensation amount so that interference in the elevator or pitch direction at that time is minimal.

*The left and right sides can be adjusted separately.

*If the interference increases when the compensation amount is increased, make the compensation direction "-".

2. Adjust the elevator compensation amount so that the interference in the aileron or pitch direction when the elevator stick was moved up and down is minimal.

3. Perform aileron and elevator compensation similarly for the throttle stick full high side.

To exit setting, touch the [Swash Details] button.

Speed compensation setting procedure

1. Set the throttle stick to the neutral point position. Move the elevator stick quickly and adjust the speed compensation amount so that the interference in the pitch direction is minimal.

To exit setting, touch the [Swash Details] button.

Note:

If the linkage is too long or short, correct compensation will not be applied. Correct this before continuing. The pitch angle changes after any adjustment. Reset the pitch angle when actually flying after compensation processing.



Timer

Timer setting and lap time display. (and Sub-display)

The Timer function may be set for any desired time, i.e. engine run time, specified times for competitions, etc. Two independent timers are provided for your use. The timers are stored independently with each model, meaning that when you switch between model setups, the timer associated with the new model is brought up automatically.

The timers may be set to start and stop from the motion of any switch or stick. You may set the ON and OFF directions freely. Each timer has a capacity of up to 59 minutes 59 seconds.

- Touch the [Timer] button in the Linkage Menu to call the setup screen shown below.

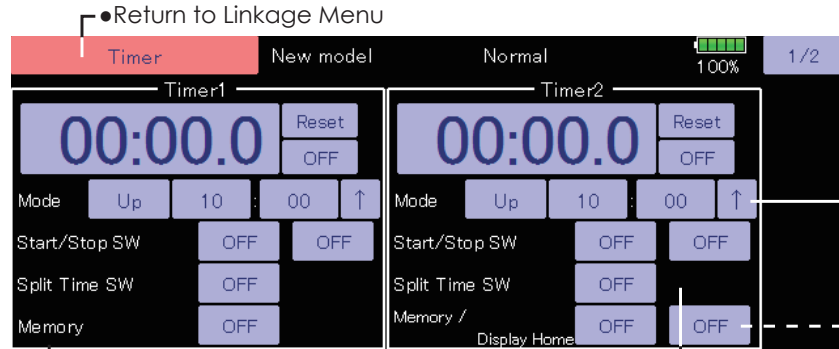

- Memory is turned ON, the power OFF and a model change will not be reset timer, either.

- [↑] An alarm sounds every minute of the elapsed time from timer start. (Conventional mode)
- [↓] An alarm sounds every minute of the remaining time up to the alarm time.

In case of helicopter type

ON: The timer 2 is displayed on the home screen.

OFF (default): Timer 2 is not displayed on the home screen. Display of 1 timer and THR Stick Pos and Pitch.

<Lap time list>

The screenshot shows the '<Lap time list>' screen. It features a table with columns for 'Lap#', 'Split Time', and 'Lap#', 'Split Time'. The table contains 24 rows of data, with lap numbers 1 through 24 and split times of 00:00.0. There are navigation buttons (up/down arrows), a 'Clear' button, and a 'Return' button.

Lap#	Split Time	Lap#	Split Time	Lap#	Split Time	Lap#	Split Time
1	00:00.0	7	00:00.0	13	00:00.0	19	00:00.0
2	00:00.0	8	00:00.0	14	00:00.0	20	00:00.0
3	00:00.0	9	00:00.0	15	00:00.0	21	00:00.0
4	00:00.0	10	00:00.0	16	00:00.0	22	00:00.0
5	00:00.0	11	00:00.0	17	00:00.0	23	00:00.0
6	00:00.0	12	00:00.0	18	00:00.0	24	00:00.0

- Return to Timer screen

Up timer/Down timer/Hour selection

1. Touch the mode button and select the type of timer.
2. Timer time setting.
Touch the Mode minutes or seconds button. Adjustment buttons appear on the screen. Use these buttons to set the timer time.

Start/SW switch setting

1. Touch the Start/Stop SW "NULL" button to call the <Switch> screen, and then select the switch and its ON direction.
(For a detailed description of the selection method, see [Switch Setting Method] at the back of this manual. The timer switches can be set for each condition.)

Lap time switch selection

1. Touch the Lap SW "NULL" button to call the Prog. Mix screen, and then select the switch and its ON direction.
(For a detailed description of the switch setting method, see [Switch Setting Method] at the back of this manual. The timer switches can be set for each condition.)

Each timer may be set for count-down or count up operation with your choice of a target time. Also split time may be set up and counted.

If a target time is set and the timer reaches this point, a buzzer will sound for each count generated.

Countdown timers sound one short beep during the last twenty seconds and two short beeps during the last ten seconds before reaching the target, then a long tone at the target time, and continue counting with displaying a minus (-) sign. Count-up timers also beep the last twenty and ten seconds, beep the target time, and keep counting upwards until shut down.

- [↑] An alarm sounds every minute of the elapsed time from timer start. (Conventional mode)
- [↓] An alarm sounds every minute of the remaining time up to the alarm time.

In case of helicopter type

ON: The timer 2 is displayed on the home screen.

OFF (default): Timer 2 is not displayed on the home screen. Display of 1 timer and THR Stick Pos and Pitch.

Timer operation

- Timer 1 and Timer 2 are started and stopped by your choice of switch.
- To count the lap time, select the lap time switch. Each time this switch is operated, the lap time is stored. To display the lap time, touch the respective [List] button.
- To reset a timer, touch the respective [Reset] button. To exit the setting, touch the [Timer] button.

Hour mode

An HOUR mode which counts up to 99 hours 50 minutes has been added to the timer modes.

- This mode is convenient when used at engine maintenance period and other long-term measurements.
- When the HOUR mode is set, "xx (hour) : xx (minute)" is displayed on the count time display. Seconds are not displayed.
- When the HOUR mode is set, ":" blinks each second during timer operation.
- When the HOUR mode is set, the alarm function/lap time measurement function are inhibited.

AIRPLANE

GLIDER

HELICOPTER

Vibration

If a set period comes, you will be alerted by vibration.

1. [1/2] is pushed on a timer screen and 2/2 screen is opened.
2. Vibration [OFF] is pushed and it is made [Type1-4]. The kind of vibration is chosen from Type1 to Type4. (The interval of vibration changes.) It can set up separately by the Timer 1 and the Timer 2.

Button Mode

A setup of operation when the timer button in a home screen is pushed.

1. [1/2] is pushed on a timer screen and 2/2 screen is opened.
2. Button mode is chosen from two.

[Setup Screen]

If the timer of a home is pushed, it will jump to a timer set up screen.

[Start/Stop]

If the timer of a home is pushed, A timer performs a start stop directly with a home screen.

- Touch the [Timer] button in the Linkage Menu, and the [1/2] button pushed, call the setup screen shown below.

- [OFF] → [Type1-4]
If it carries out like this, a vibration function will work.

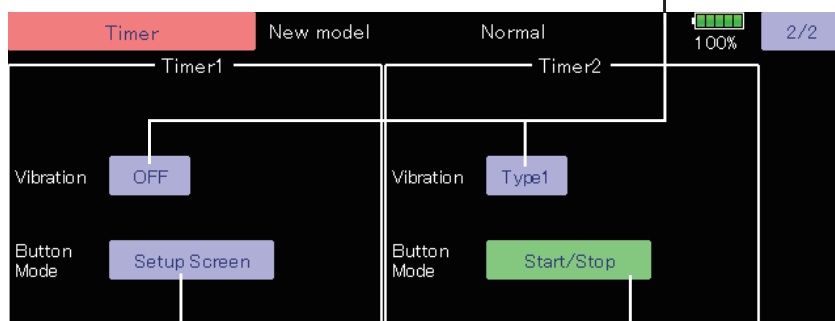

- [Setup Screen]
If the timer of a home is pushed, it will jump to a timer set up screen.

- [Start/Stop]
If the timer of a home is pushed, A timer performs a start stop directly with a home screen.

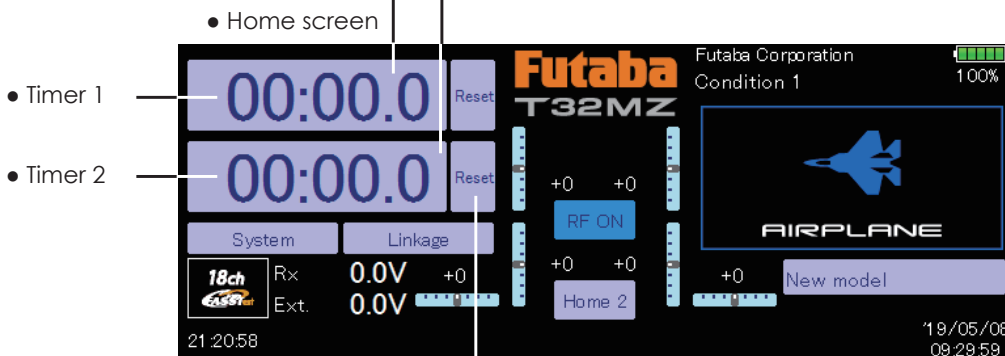

- Timer 1
- Timer 2

- Home screen

- A time is reset.



Dial Monitor

Displays the position of the dials, slider levers, and digital trim.

Digital trim position display (T1-T6)

The Dial Monitor displays the current position and step amount of each digital trim. The trim step can be set directly on the dial monitor.

Digital trim step amount (T1-T6)

The trim step of the T1-T6 can be set directly on the dial monitor menu.

VR and slide lever position display (LST, LS, LD, RD, RS, RST)

Displays the current position (black▼) and last operating position (green▲) of the VRs and slider levers.

- Touch the [Dial Monitor] button in the Linkage Menu to call the setup screen shown below.

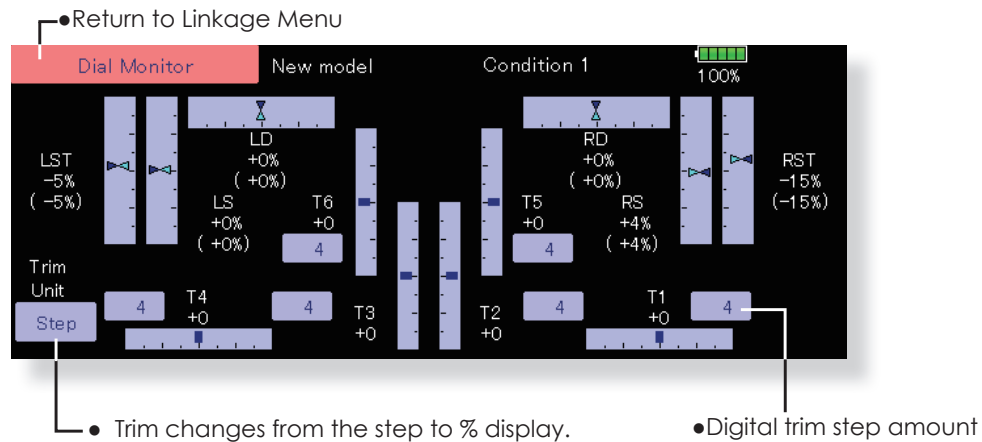

Knob and Lever Position display (LST, LS, LD, RD, RS, RST)

The Dial Monitor displays the current position and last operating position of each knob and lever. Although neither knob nor lever can hold the last operation position as they are “analog” type, the position data during the last operation is memorized in the model memory. By moving the knob and lever to the position displayed on the monitor, the last operation position is recalled.

Recalling Dial Position (LST, LS, LD, RD, RS, RST)

The dial position data at the last operation is displayed for each knob and lever in this monitor. (Green arrow)

1. Move the black arrow (current position) to the green arrow position by operating the desired knob or lever to recall the last operating position.

AIRPLANE

GLIDER

HELICOPTER

Function Name

Function Names can be changed in this menu.

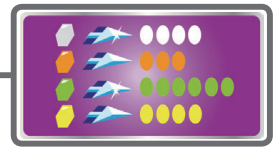

The setup screen will display function names in both 10 and 4 characters.

AIRPLANE

- Touch the [Function Name] button in the Linkage Menu to call the setup screen shown below.

GLIDER

HELICOPTER

Return to Linkage Menu

Please select a function.

Aileron	Elevator	Throttle	Rudder	Gear	Flap	Aileron2	Aileron3
Aileron4	Elevator2	Flap2	Air Brake	Fuel-Mix	Gyro	Gyro2	Gyro3
Throttle2	Throttle3	Throttle4	Flap3	Flap4	Rudder2		Camber
Motor	Auxillary7	Auxillary6	Auxillary5	Auxillary4	Auxillary3	Auxillary2	Auxillary1

Function Name

10 Characters

Current: Aileron

Default: Aileron

4 Characters

Current: AIL

Default: AIL

Rename

Reset

Close



Telemetry

Displaying data from the receiver

⚠ WARNING

! Do not watch the transmitter screen during flight.

*You may lose sight of the aircraft during flight and this is extremely dangerous. Have an assistant on hand to check the screen for you. A pilot should never take his eyes off his aircraft.

This screen displays your choice of data from the receiver.

Also warnings can be activated regarding the data. For example, if the receiver voltage drops, the user can be warned by an alarm (and vibration).

There are two methods for seeing data.

1. See on home 2 screen. → A call is easy. The data to 3 is displayed.
2. See on telemetry screen. → All the data is displayed.

Telemetry data is displayed on the home 2

- Call the following setting screen by pressing the [Telemetry] button of the Linkage Menu.

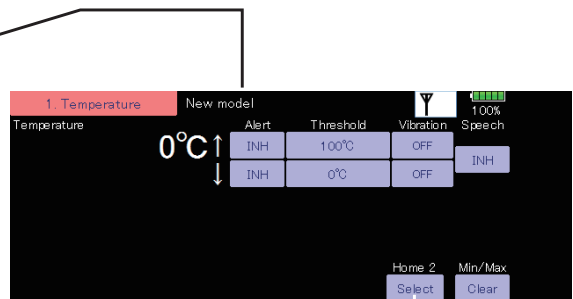
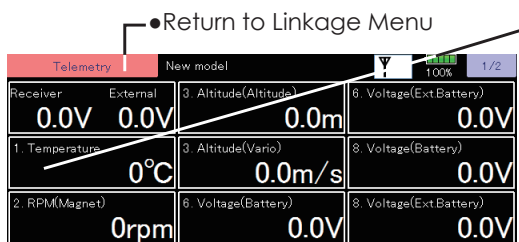

- It can also call by this method. Home screen [Home2] → Arbitrary sensors → Home2 [Select]

•The slot number of the sensor displayed on a screen is chosen.

- It chooses whether to make it display.

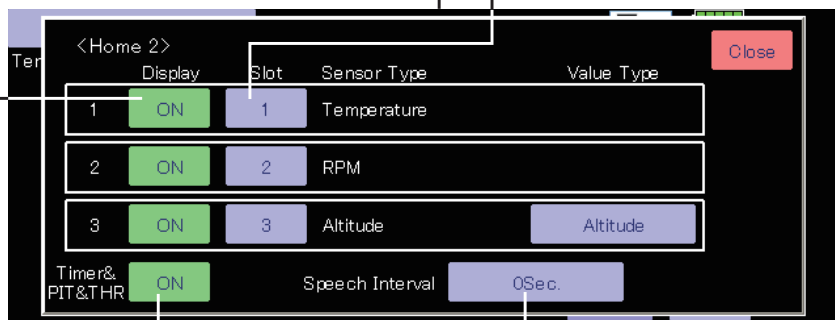

•The interval which gives a speech data . (0-30 sec)

•When giving a speech, it chooses OFF.

- Home2 display



*In the case of a helicopter, the position of PIT and THR is displayed. A timer display is one.

- Home2 display

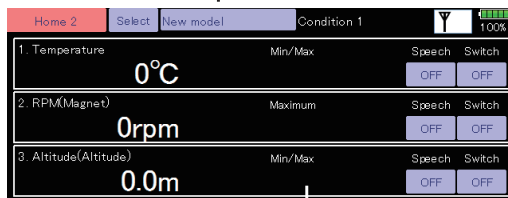

•This display is the maximum/ minimum after starting reception until it turns off a transmitter.

AIRPLANE

GLIDER

HELICOPTER

Audible telemetry information

In addition to the on-screen telemetry data information, the T32MZ now has the ability to audibly indicate the aircraft status.

AIRPLANE

- The voice is in english.
- The audible indicator is capable of noting the data from any (or all) of the three sensors selected.
- When using the voice read function set the [Timer and PIT and THR] setting of the home 2 screen to the [OFF] mode.
- It is possible to adjust how often the data is conveyed to the modeler. The frequency ranges from 0-30 seconds. If set at 0, updates will occur continuously. If set to 30, updates will occur every 30 seconds.
- The T32MZ offers the ability to adjust the volume of the audible telemetry data. The volume for the telemetry data is combined with the Error/Warning volume. To access this adjustment: [System Menu] → [Sound Volume] → Error/Warning.
- When only one kind of data is set to read ON, the data is repeatedly read in the following order:
[Sensor Type, Data, Units] [Data] [Data] [Data] [Data]

(Example) Reading of receiver voltage

"Battery eight point one volt, eight point one, eight point one, eight point one, eight point one, battery..." is repeated. If you have activated the audible indicators for multiple sensors, the T32MZ will cycle through the indicators at the selected timing intervals accordingly.

- When the voice read function is turned on for telemetry data with alarm set when an alarm is activated; a voice alarm is given in addition to the alarm sound when the alarm was activated.
["Warning"] [Sensor Type, Data, Units]

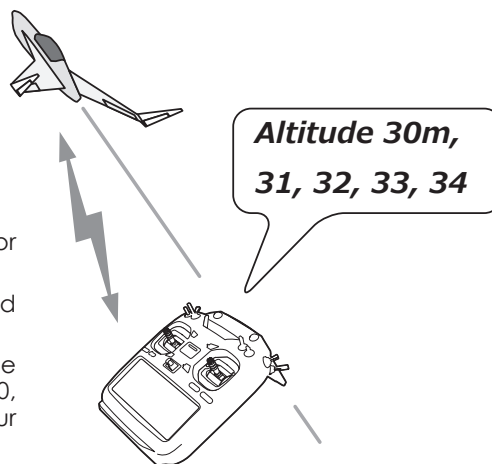

GLIDER

HELICOPTER

• Home screen → Home2 screen

• It will give a speech, if turned on.

Item	Value	Unit	Scale	Speech	Switch
1. Temperature	0°C		Min/Max	OFF	OFF
2. RPM(Magnet)	0rpm		Maximum	OFF	OFF
3. Altitude(Altitude)	0.0m		Min/Max	OFF	OFF

• It is also possible to turn the audible information on/off by the use of an arbitrary switch and/or switch position.

A setup of each sensor display

- Call the following setting screen by pressing the [Telemetry] button of the Linkage Menu.

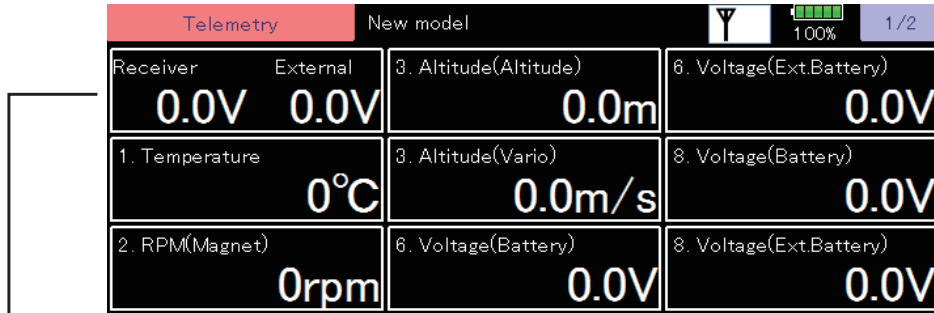

- What is registered by the "Sensor" of the following clause is displayed.

- About the preset value of Threshold.

The preset value of ↑ maximum is not made below the preset value of ↓ minimum.

The preset value of ↓ minimum is not made above the preset value of ↑ maximum.

Receiver Battery Display

- Receiver battery voltage
- External Input voltage (Extra Voltage connector)
- Return to Telemetry
- A downward arrow shows that the alarm operates, when less than the set-up numerical value.
- If voltage falls further than the voltage set up here, the alarm will operate.
- Change of a numerical value
- Press to setup an alert.
- It is selection of the sensor displayed on home 2 screen.
- INH → ACT ; a voice alarm is given in addition to the alarm sound when the alarm was activated.
- Display of the maximum and minimum ranges for voltage. [Clear] to reset.
- Press to setup vibration alerts. 4 types of vibration selections are possible.
- This display is the maximum and minimum after starting reception until it turns off a transmitter.

*In order to measure Ext. Battery voltage, **CA-RVIN-700** (EXTERNAL VOLTAGE INPUT CABLE) of an option is required.

AIRPLANE

GLIDER

HELICOPTER

Temperature Display

*Temperature sensor **SBS-01T/TE** is required.

AIRPLANE

- Temperature Display
- Return to Telemetry
- If temperature reaches higher than the temperature set up here, the alarm will operate.
- If temperature becomes lower than the temperature set up here, the alarm will operate.
- Change of a numerical value
- Press to setup an alert.
- Press to setup vibration alerts. 4 types of vibration selections are possible.
- This display is the maximum and minimum after starting reception until it turns off a transmitter.
- It is selection of the sensor displayed on home 2 screen.
- INH → ACT ; a voice alarm is given in addition to the alarm sound when the alarm was activated.
- Display of the maximum and minimum ranges for temperature. [Clear] to reset.

GLIDER

RPM Display

*RPM sensor **SBS-01RM/RO/RB** is required.

HELICOPTER

"Magnet"	SBS-01RM →	Gear ratio	1.00~600.00
"Optics"	SBS-01RO →	Fin	2~15
"Brushless motor"	SBS-01RB →	Pole	2~30

- RPM Display
- Return to Telemetry
- If RPM goes higher than the RPM set here, the alarm will operate.
- If RPM goes lower than the RPM set here, the alarm will operate.
- INH → ACT ; a voice alarm is given in addition to the alarm sound when the alarm was activated.
- Change of a numerical value
- Press to setup an alert.
- Press to setup vibration alerts. 4 types of vibration selections are possible.
- The display of the maximum after carrying out power ON
- It is selection of the sensor displayed on home 2 screen.
- Touch the [Condition] button. The screen that appears next denotes the maximum RPM achieved for each of the flight conditions programmed into the transmitter.
- Display of the maximum ranges for RPM. [Clear] to reset.

Altitude Display

*Altitude sensor **SBS-01/02A** is required.

Atmospheric pressure is measured by a sensor. The actual altitude is measured in regards to the difference between the ground and atmospheric pressure.

Atmospheric pressure when the power supply of the altitude sensor is set to ON is displayed as a standard (0 m).

[Reset] Push the button to re-set to a standard altitude.

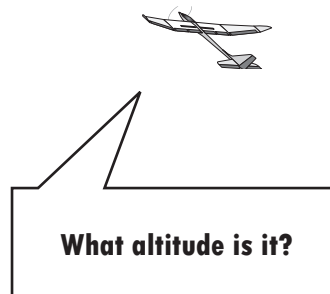

• Variometer Display : How many meter rise (descent) in 1 second.

• Return to Telemetry

• Altitude Display

• Press to setup an alarm type alert.

• If Altitude becomes higher than the Altitude set here, the alarm will operate.

• If Altitude becomes lower than the Altitude set here, the alarm will operate.

• Change of a numerical value

• Atmospheric pressure Display

• This display is the maximum and minimum after starting reception until it turns off a transmitter.

• Press to setup vibration alerts. 4 types of vibration selections are possible.

• If Preset is pushed, the present atmospheric pressure = altitude of 0 m.

• INH → ACT ; a voice alarm is given in addition to the alarm sound when the alarm was activated.

• Display of the maximum and minimum ranges for RPM. [Clear] to reset.

• It is selection of the sensor displayed on home 2 screen.

3. Altitude	New model	Melody	100%
Altitude	Alert	Threshold	Vibration
0.0m	INH	200.0m	OFF
min-max	INH	-50.0m	OFF
Vario	INH	0.0m/s	OFF
0.0m/s	INH	0.0m/s	OFF
min-max	Melody	Reference(Alt.)	Home 2
Pressure	INH	Preset	Select
0.0hPa	NULL		Min/Max
			Clear

Variometer melody function

When using a variometer, the T32MZ offers the option of incorporating a tonal indication of the aircraft's rate of ascent or descent.

- To ensure that the pilot is aware as to the model's status, the T32MZ incorporates a different melody for ascent and descent. Additionally, depending upon the rate of climb or descent, the tones vary to indicate whether or not the airplane is climbing or descending at a rapid rate.
- The melody function and the voice read function can be used simultaneously. When the voice read function was turned on data is read as follows:

Climbing: ["Climb" climb speed "m/s"]

Sinking: ["Sink" sink speed "m/s"]

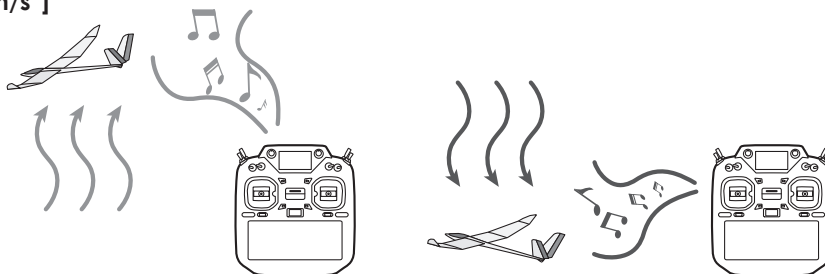

AIRPLANE

GLIDER

HELICOPTER

Vario Melody Setting

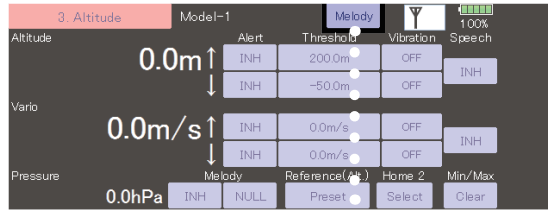

Tap the [Melody] button

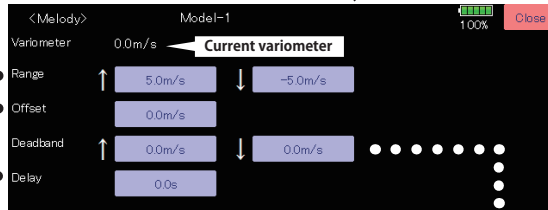

*These settings can be set each sensors.

AIRPLANE

GLIDER

HELICOPTER

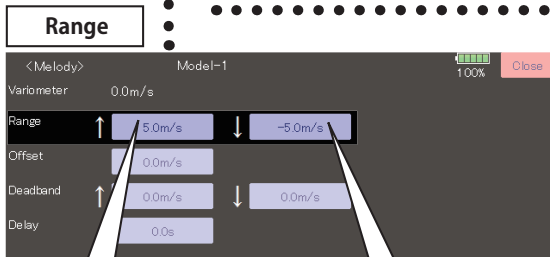

When the variometer is greater than this value, Vario melody is not variable.
Setting range :
 Offset value ~ +50 m/s
Initial value : 5.0 m/s

When the variometer is less than this value, Vario melody is not variable.
Setting range :
 -50 m/s ~ Offset value
Initial value : -5.0 m/s

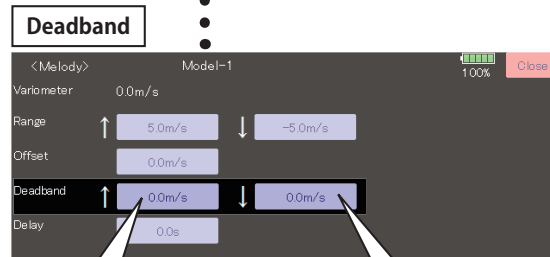

When the variometer is less than this value, Vario melody is not output.
Setting range : 0 m/s ~ +50 m/s
Initial value : 0.0 m/s

When the variometer is greater than this value, Vario melody is not output.
Setting range : -50 m/s ~ 0 m/s
Initial value : 0.0 m/s

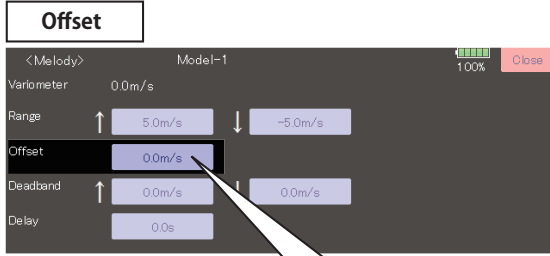

This is the changing point of climb and sink. When the variometer is greater than this value, Vario Melody is climb type. When the variometer is less than this value, Vario Melody is sink type.
Setting range : Range ↑ setting value ~ Range ↓ setting value
Initial value : 0.0 m/s

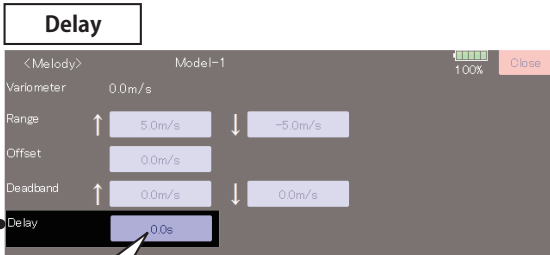
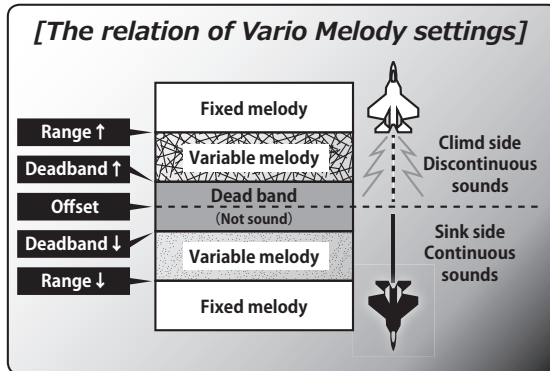

The output vario melody does not change during the delay time. In other words, this is a minimum time of Vario melody output.
Setting range : 0.0 s, 0.5 s, 1.0 s, 1.5 s
Initial value : 0.0 s

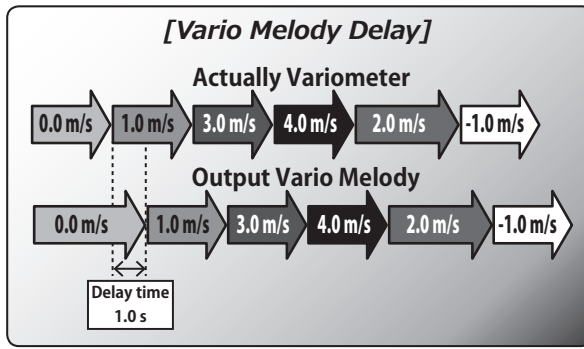

*This parameter is effective to all variometers.

GPS Display

*GPS sensor **SBS-01/02G** is required.

Futaba's GPS sensor (SBS-01/02G) obtains position data from GPS, and displays the speed calculated from the distance, and distance from a preset position.

Additionally the sensor includes an accurate atmospheric pressure sensor that provides altitude and variometer (vertical speed) data.

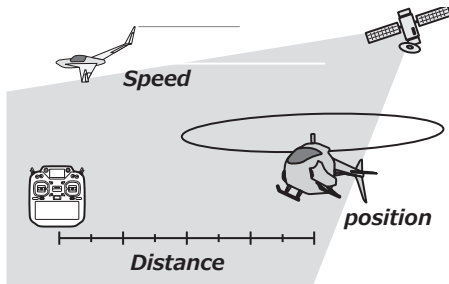

*Positioning time of GPS



When powered up, the SBS-01/02G begins to acquire GPS satellite data. This process can take several minutes. Please do not move the model during this process. During acquisition, the LED on the SBS-01/02G will blink green; after the satellites signals have been acquired, the LED will become solid green, and the GPS signal strength display on the transmitter will show three bars.

Moving the model before the satellites are fully acquired will cause a delay in acquiring the satellite signal.

The screenshot shows the transmitter's GPS display menu. The menu is divided into several sections: Distance, Speed, Position, and a bottom section with various function buttons. Annotations explain the settings and functions:

- Distance:** Shows '24. GPS' and 'Model-1'. The current distance is '0m'. A 'min-max' range is indicated. Annotations: 'If this value is exceeded, the alarm will operate', 'If it becomes lower than this value, the alarm will operate', 'This display is the distance to a model. (↔ preset position)', 'Return to Telemetry', 'Press to setup an alarm type alert'.
- Speed:** Shows '0km/h' and 'min-max' range. Annotations: 'Speed Display'.
- Position:** Shows 'Map', 'N 0° 00.0000', 'E 0° 00.0000'. Annotations: 'Map display', 'Current model position'.
- Alert:** Shows 'INH', 'Threshold', 'Vibration', 'Speech'. The 'Threshold' is set to '100m'. Annotations: 'If preset is pushed, distance of 0 m', 'This selects of the sensors displayed on home 2 screen'.
- Receiver → transmitter signal strength:** Shows a bar graph at '100%'.
- ALT:** Shows 'ALT' and 'ΔΔ'. Annotation: 'ALT displays data from the atmospheric pressure sensor. GPS displays data from the GPS. Press to change'.
- INH → ACT:** Shows 'INH', 'Δ', 'Reset', '▽', '▽▽'. Annotations: 'INH → ACT; When activated a voice alert will also sound in addition to the alarm.', 'Change of a numerical value', 'Display of the maximum ranges [Clear] to reset'.
- Bottom Section:** Shows 'Distance', 'Position', 'Home 2', 'Min/Max', 'Clear', 'Surface', 'Preset', 'Select'. Annotations: 'Change of a numerical value', 'Display of the maximum ranges [Clear] to reset', 'Press to setup vibration alerts. 4 types of vibration selections are possible'.

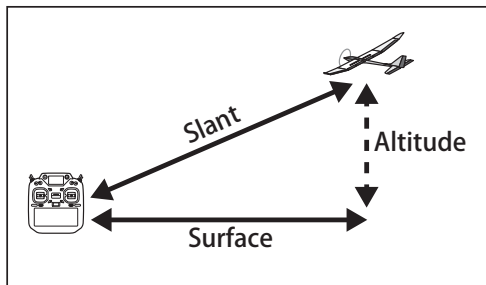

AIRPLANE

GLIDER

HELICOPTER

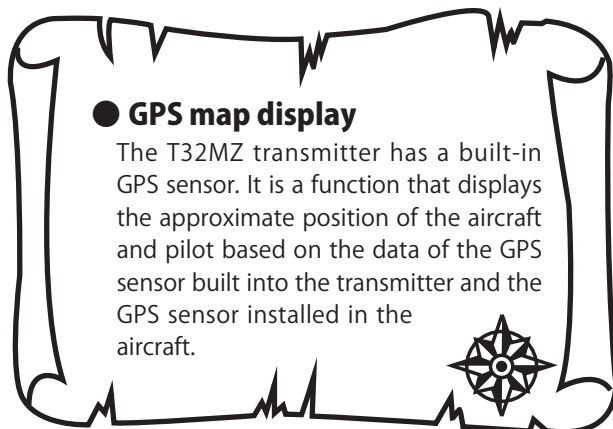

● **GPS map display**

The T32MZ transmitter has a built-in GPS sensor. It is a function that displays the approximate position of the aircraft and pilot based on the data of the GPS sensor built into the transmitter and the GPS sensor installed in the aircraft.

Equipped with GPS sensor



●GPS screen

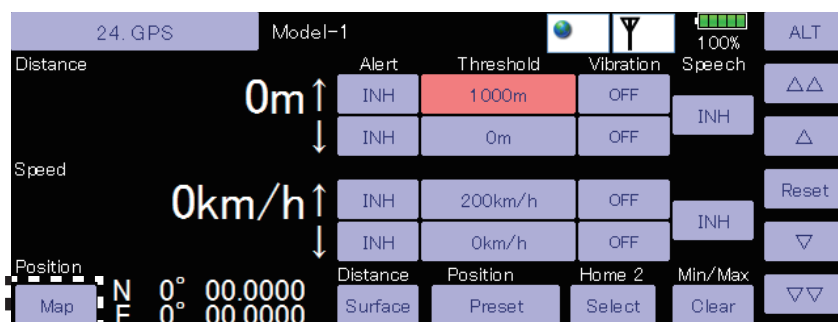

●MAP screen

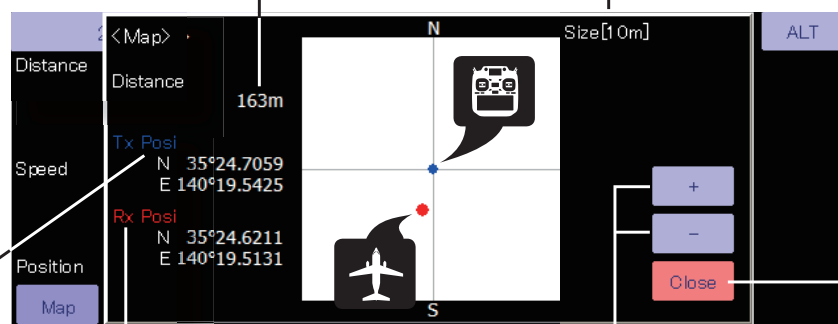

●It is the size of the map. It is the distance from the Tx position (reference point at the center of the map) to the end. Change the size with the +/- button.

●Distance between transmitter and aircraft

●Displays the latitude and longitude of the GPS sensor installed on the aircraft. It is displayed on the map with a red mark.

●Displays the latitude and longitude of the GPS sensor built into the transmitter. It appears as a blue mark on the map and always appears as a reference point in the center of the map.

●Close the MAP

●Change the size of the map in the range of 10 m to 10000 m. The + button zooms in and the - button zooms out.

The top of the map is north and the bottom is south.

Voltage Display

*Voltage sensor **SBS-01V** is required.

The SBS-01V has the capability of measuring voltage from two different batteries at the same time. It will measure the voltage that its normal 3-pins connector is plugged into, such as a receiver or servo battery pack ; additionally, it has an external lead that can be used to measure high voltages like drive batteries.

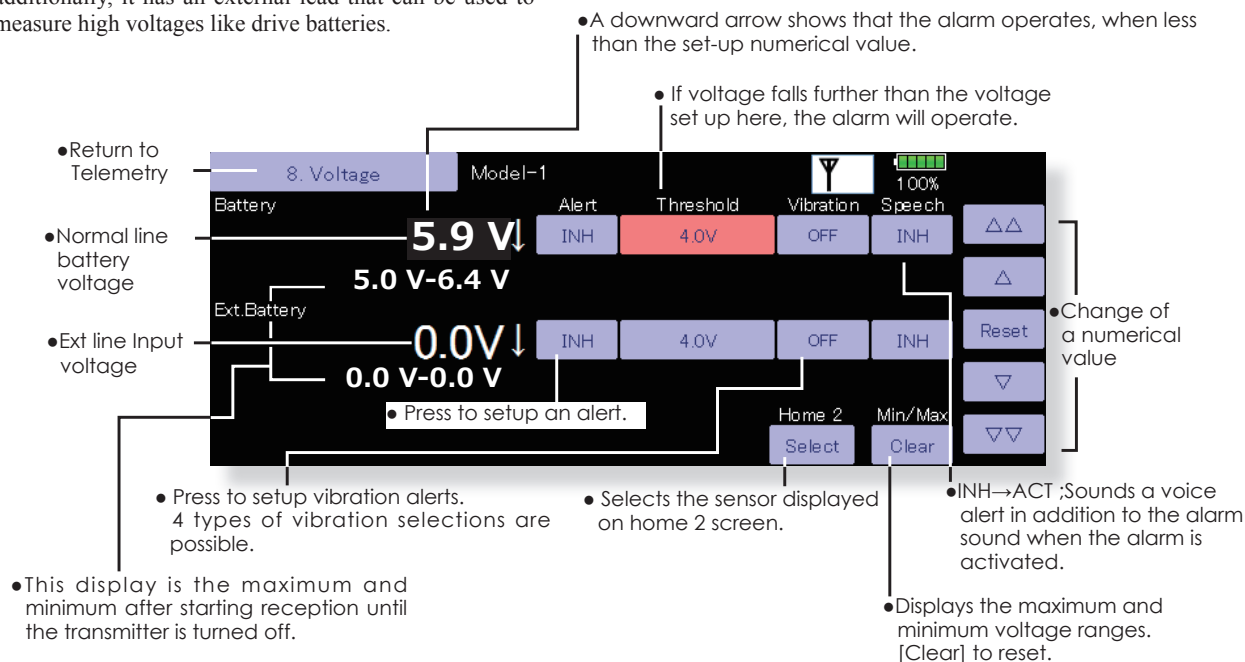

< Two examples of wiring are shown >

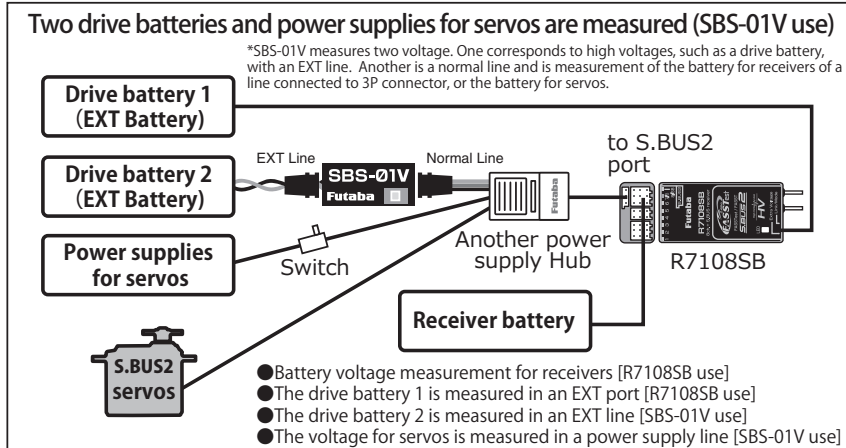
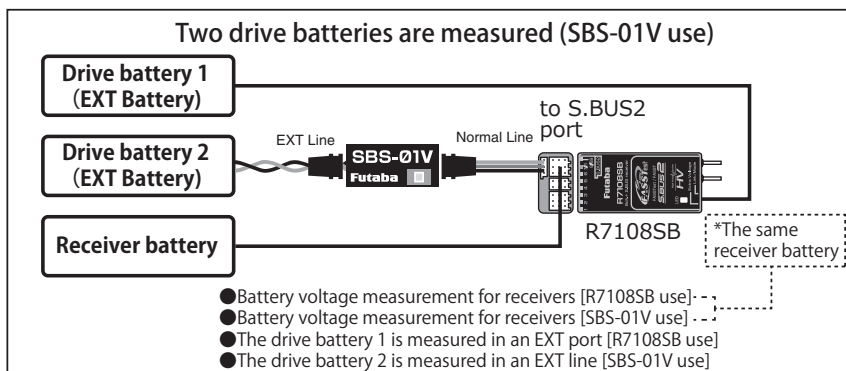

*Refer to the manual of SBS-01V for the details of wiring.

AIRPLANE

GLIDER

HELICOPTER

Current/Voltage/Capacity Display

*Current sensor **SBS-01C** is required.

The SBS-01C has the capability of measuring current, voltage and capacity from drive battery at the same time.

AIRPLANE

• Return to Telemetry

• Drive battery current

• Drive battery voltage

• Press to setup an alert.

• Press to setup vibration alerts. 4 types of vibration selections are possible.

• This display is the maximum and minimum after starting reception until the transmitter is turned off.

• If this value is exceeded, the alarm will operate

• If it becomes lower than this value, the alarm will operate

• Selects the sensor displayed on home 2 screen.

• Displays the maximum and minimum value ranges. [Clear] to reset.

• INH→ACT ; Sounds a voice alert in addition to the alarm sound when the alarm is activated.

• Change of a numerical value

GLIDER

• Drive battery capacity

HELICOPTER

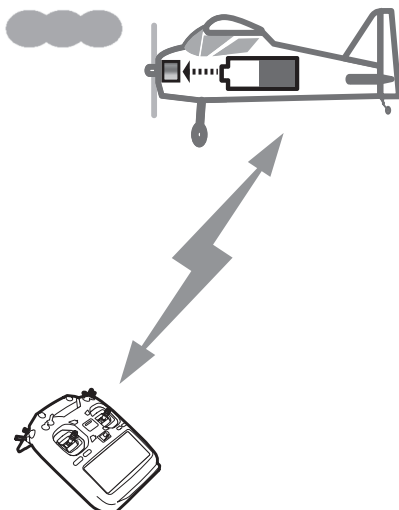

*Refer to the manual of SBS-01C for the details of wiring.

Servo sensor Display

*Servo sensor **SBS-01S** is required.

S.BUS2 servo only

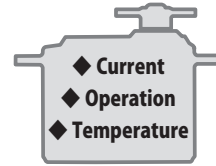

• Servo1 Current Display

• Servo1 Temperature Display

• Return to Telemetry

• If this value is exceeded, the alarm will operate

• If it becomes lower than this value, the alarm will operate

• Press to setup an alert.

• Press to setup vibration alerts. 4 types of vibration selections are possible.

• This display is the maximum and minimum after starting reception until it turns off a transmitter.

• INH → ACT ; a voice alarm is given in addition to the alarm sound when the alarm was activated.

• Display of the maximum and minimum ranges for temperature. [Clear] to reset.

• Change of a numerical value

• INH → ACT ; a voice alarm is given in addition to the alarm sound when the alarm was activated.

• It is selection of the sensor displayed on home 2 screen.

• INH → ACT ; a voice alarm is given in addition to the alarm sound when the alarm was activated.

• Display of the maximum and minimum ranges for temperature. [Clear] to reset.

AIRPLANE

• Servo1 Angle Display

• 1/4: Servo1 [Current][Temp]

• 2/4: Servo1 [Angle][Connection]

• 3/4: Servo2 [Current][Temp]

• 4/4: Servo2 [Angle][Connection]

GLIDER

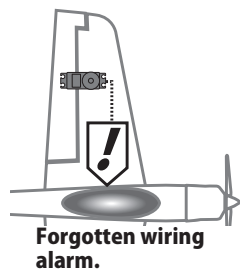

• Servo connection alarm :
If you forget to connect the servo wiring during fuselage assembly, or the servo was disconnected, an alarm can be activated at the transmitter.

• Connection error display

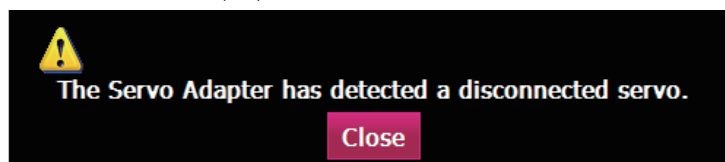

HELICOPTER

Airspeed sensor Display

*Airspeed sensor **SBS-01TAS** is required.

The SBS-01TAS can measure the airspeed (relative speed between airplane and air). And display it on the transmitter. The speed is measured from the pressure of the wind that the pitot tube receives. Unlike the ground speed measured by the GPS sensor, you can know the actual speed of the aircraft without headwind and tailwind effects.

AIRPLANE

GLIDER

HELICOPTER

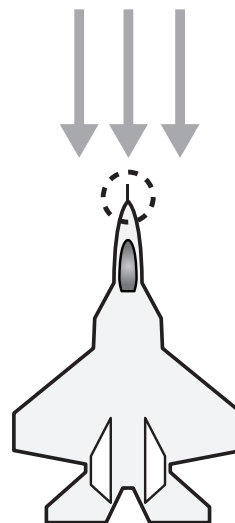
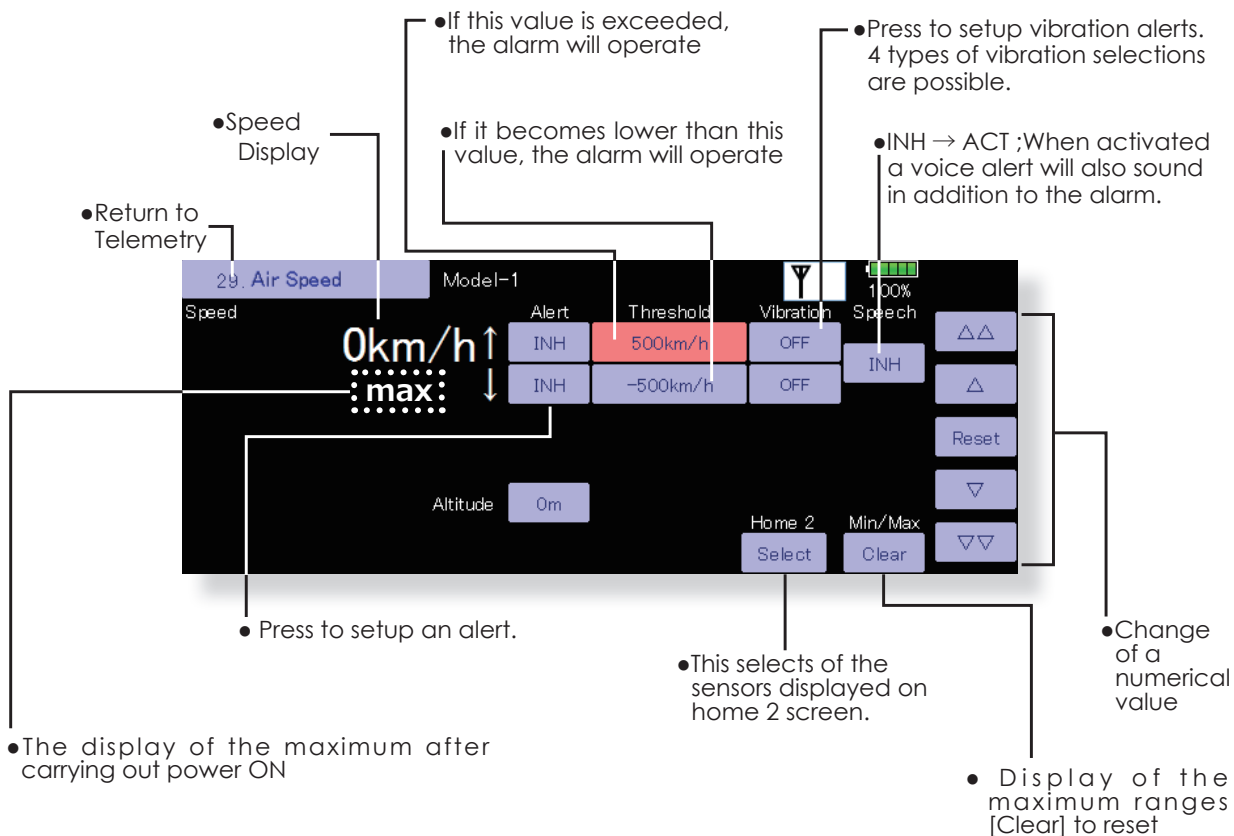

Sensor

Various telemetry sensors setting.



The telemetry sensor slot number and which sensor is used in each slot can be changed in this screen.

Since the sensor in each slot is determined at initialization and the same slot number is memorized even for sensors sold separately, sensors can be used by simply connecting them to S.BUS2. When customizing the sensors yourself, perform the settings in this screen.

- *Three slots of altitude sensor are used.
- *Eight slots of GPS sensor are used.

- Touch the [Sensor] button in the Linkage Menu to call the setup screen shown below.

•Return to Linkage Menu

•Sensor ID (It is unnecessary when using every one sensor of several kinds. 0 may still be sufficient)

Slot	Sensor	ID	Slot	Sensor	ID	Slot	Sensor	ID
1	Temperature	0	7	Voltage		13	GPS	
2	RPM	0	8	GPS	0	14	GPS	
3	Altitude	0	9	GPS		15	GPS	
4	Altitude		10	GPS		16	Inhibit	
5	Altitude		11	GPS		17	Inhibit	
6	Voltage	0	12	GPS		18	Inhibit	

[What is a slot?]

Servos are classified by CH, but **sensors** are classified in units called “slot”. There are **slots** from #1 to #31.

Altitude sensors, GPS sensors and other data sensor units may use **multiple slots**.

By the sensor which uses two or more slots, the required number of slots is automatically assigned by setting up a **start slot**.

When 2 or more of the same kind of sensor are used, the sensors themselves must allocate unused slots and memorize that slot.

< Assignable slot >

- *Altitude sensors, GPS sensors and other data sensor units may use multiple slots.
- *The sensor which uses two or more slots has restriction in a start slot.

Sensor	The required number of slots	The number which can be used as a start slot	Selling area
TEMP (SBS-01T, SBS-01TE)	1 slot	1 ~ 31	Global
RPM (SBS-01RM, SBS-01RO, SBS-01RB)	1 slot	1 ~ 31	
Airspeed (SBS-01TAS)	1 slot	1 ~ 31	
Voltage (SBS-01V)	2 slots	1, 2, 3, 4, 5, 6, 8, 9, 10, 11, 12, 13, 14, 16, 17, 18, 19, 20, 21, 22, 24, 25, 26, 27, 28, 29, 30	
Altitude (SBS-01/02A)	3 slots	1, 2, 3, 4, 5, 8, 9, 10, 11, 12, 13, 16, 17, 18, 19, 20, 21, 24, 25, 26, 27, 28, 29	
Current (SBS-01C)	3 slots	1, 2, 3, 4, 5, 8, 9, 10, 11, 12, 13, 16, 17, 18, 19, 20, 21, 24, 25, 26, 27, 28, 29	
S.BUS2 Servo sensor (SBS-01S)	6 slots	1, 2, 8, 9, 10, 16, 17, 18, 24, 25, 26	
GPS (SBS-01/02G)	8 slots	8, 16, 24	
TEMP125-F1713	1 slot	1 ~ 31	Europe
VARIO-F1712	2 slots	1, 2, 3, 4, 5, 6, 8, 9, 10, 11, 12, 13, 14, 16, 17, 18, 19, 20, 21, 22, 24, 25, 26, 27, 28, 29, 30	
VARIO-F1672	2 slots	1, 2, 3, 4, 5, 6, 8, 9, 10, 11, 12, 13, 14, 16, 17, 18, 19, 20, 21, 22, 24, 25, 26, 27, 28, 29, 30	
CURR-F1678	3 slots	1, 2, 3, 4, 5, 8, 9, 10, 11, 12, 13, 16, 17, 18, 19, 20, 21, 24, 25, 26, 27, 28, 29	
GPS-F1675	8 slots	8, 16, 24	
Kontronik ESC	8 slots	8, 16, 24	
ROXXY	5 slots	1, 2, 8, 9, 10, 16, 17, 18, 24, 25, 26	
JetCat V10	14 slots	1, 2, 3, 4, 5, 6, 7, 8, 9, 10, 11, 12, 13, 14, 15, 16, 17, 18	
PowerBox	16 slots	8, 16	

AIRPLANE

GLIDER

HELICOPTER

Next explanation is required when using two or more the same kind of sensors.

【Example 1 Altitude sensor × 1, Temperature sensor × 1】

A setup is unnecessary. Two sensors are packed by HUB and it connects with S.BUS2 of a receiver.

【Example 2 Altitude sensor × 1, Temperature sensor × 2】

It is unnecessary to set up one altitude sensor and one temperature sensor. Sensor registration is required for two temperature sensors.

Sensor unit registration

The sensor unit of each transmitter slot is registered and the slot number of each sensor unit is changed automatically.

1. Connect the sensor to the S.I/F connector in the rear of the transmitter.
2. Open the sensor unit setting screen by touching the [Sensor] button in the Linkage Menu.
3. Touch the 1/2 to enter the second page of the Sensor screen. Then, touch the [Register] button.
4. If registration is successful, the following screen will appear. **"The registering succeeded."** Close the message by touching the [Close] button.
5. If registration failed, a screen like the following will appear:

"There are not enough available slots"

Some sensors require multiple continuous slots for their operation. For example, slots 3-6. If continuous slots are not available, these sensors will not be registered accordingly. If there are unused slots, but they are not continuous, please use the Sensor Unit Reallocation feature, which follows, to change the slots of the existing sensors to accommodate the sensors which require continuous slots.

-Altimeter: 3 slots required

-GPS: 8 slots required

"The connected sensor is not ready"

No response from sensor unit. Check the connections.

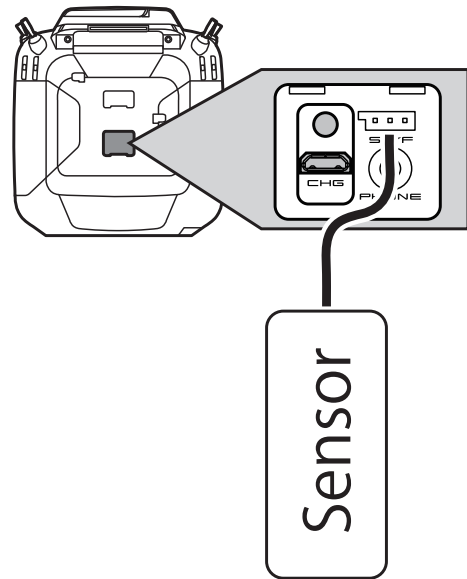

Sensor unit reallocation

This function is used to reallocate slots to ensure that all sensors are registered and operate as desired. As noted above, some sensors require adjoining, or continuous, slots in order to register properly. Examples of such sensors include but are not limited to, altimeters and GPS units.

1. To properly reallocate the slots, it is necessary to connect all registered units to the S.I/F connector in the rear of the transmitter. Additionally, it is necessary to these sensor units via a 3-way hub or two-way cord.
2. Open the sensor unit setting screen by touching the [Sensor] button in the Linkage Menu.
3. Touch the 1/2 to enter the second page of the setting screen. Then, touch the [Relocate] button.
*It will take time, if many sensors are connected. Wait then.
4. If reallocation was successful, a screen like the following will appear:

"All sensors are relocated successfully"

If all the registered sensors are not connected, the following message is displayed and reallocation is not performed. Set slots allocated to unused sensors to [Inhibit] on the sensor unit setting screen.

"Some sensors of the registered sensors cannot be found."

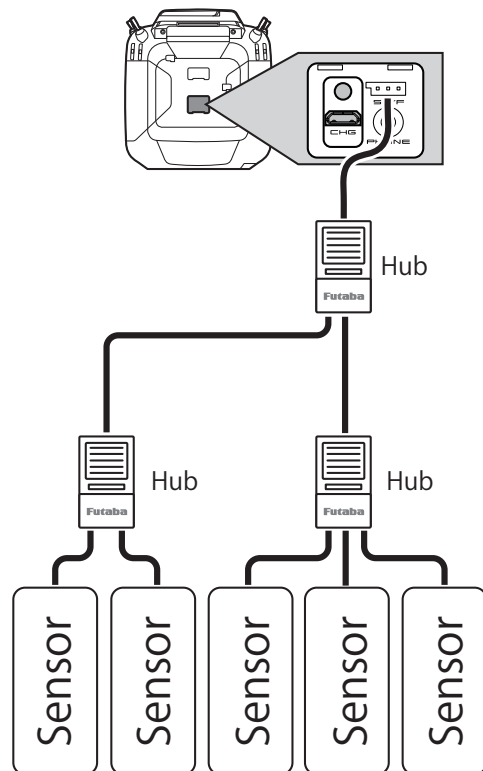

AIRPLANE

GLIDER

HELICOPTER

Next explanation is required when using two or more the same kind of sensors.

Sensor unit setting reread

This function rereads the slot number setting of the connected sensor units. This is a convenient way to allow another T32MZ user to pilot your aircraft.

1. Connect all registered units to the S.I/F connector in the rear of the transmitter. Additionally, it is necessary to connect these sensor units via a 3-way hub or two-way cord.
2. Open the sensor unit setting screen by touching the [Sensor] button in the Linkage Menu.
3. Touch the 1/2 to enter the second page of the setting screen. Then, touch the [Reread] button.
4. If reread was successful, a screen like the following is displayed:

"The reloading the configuration of sensors succeeded."

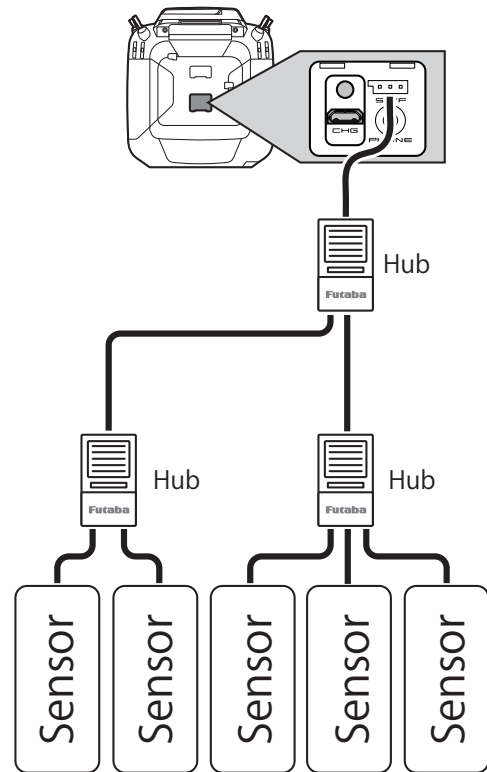

The procedure described below is in 2/2 of the sensor screens.

- Call the following setting screen by pressing the [1/2] button of the sensor display.

•Return to Linkage Menu

Sensor			Model-1			100%			2/2
Slot	Sensor	ID	Slot	Sensor	ID	Slot	Sensor	ID	
19	Inhibit		25	Inhibit		31	Inhibit		
20	Inhibit		26	Inhibit			Reload		•Sensor unit setting reread
21	Inhibit		27	Inhibit			Relocate		•Sensor unit reallocation
22	Inhibit		28	Inhibit			Register		•Sensor unit registration
23	Inhibit		29	Inhibit			Change Slot		•Changing the slot number
24	Inhibit		30	Inhibit					

Next explanation is required when using two or more the same kind of sensors.

It is necessary where a sensor is registered manually here.

This item is unnecessary if "Sensor unit registration" is performed.

AIRPLANE

Procedure for changing the slot number of each sensor unit

1. Select [Sensor] on page 2 of the Linkage Menu.
2. Call page 2 by pressing [1/2] and press [Change Slot].
3. Connect the sensor unit to the S.I/F connector behind the rear cover of the transmitter using a 3-way hub or 2-way cord.
4. Press the [Read] key. The current slot number is displayed.
5. When a number is pressed, the [△], [▽], [△△] and [▽▽] keys appear. Now change the desired number.
6. When the [Write] key is pressed, the desired number is written to the sensor.

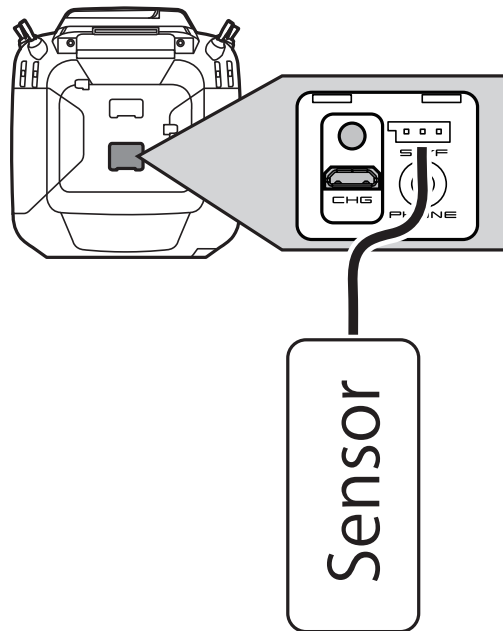

GLIDER

- Call this screen by switching to page 2 by pressing the [1/2] button on the Sensor screen and then pressing [Change Slot].

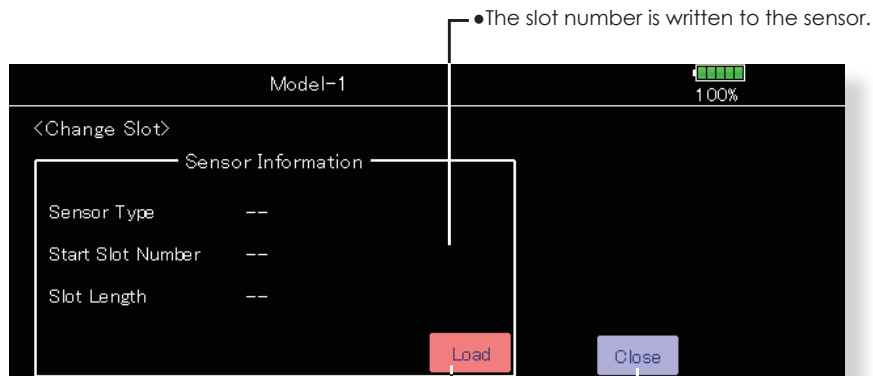

- The slot number is written to the sensor.
- When pressed, the current slot number is displayed.
- Returns to the sensor screen.

HELICOPTER

Procedure for changing the sensor of each slot number

1. Select [Sensor] from the Linkage Menu.
 2. Select the sensor of the slot number to be changed.
 3. Select the type of displayed sensor.
 4. When the [Yes] key is pressed, the type of sensor is changed.
- *In the case of a sensor which uses more than one slot, you may be unable to reassign.

**Next explanation is required when using two or more the same kind of sensors.
It is a case where a sensor is registered manually here.
This item is unnecessary if "Sensor unit registration" is performed.**

Sensor unit ID setting

ID of the sensor registered into each slot can be changed manually. Alternatively, registration of the sensor may be accomplished through the sensor unit registration function which follows. (ID is inputted automatically)

- Call the following setting screen by pressing the ID number button of the sensor display.

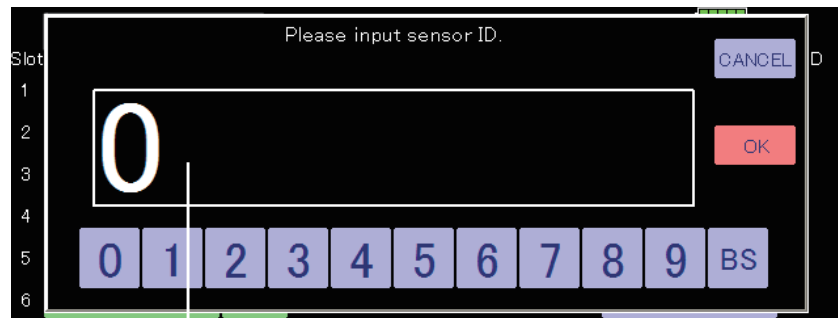

- To manually enter, or change the identification of the desired sensor (s), input the identification using the touchpad. When completed, press OK.

AIRPLANE

GLIDER

HELICOPTER

Sensor Name

Change the sensor name

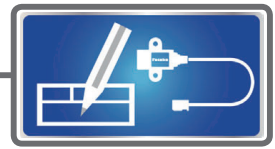

As the name suggests, this feature allows you to rename the sensors accordingly. This is very useful when a model has multiple sensors of the same variety (e.g., temperature).

AIRPLANE

- Call the following setting screen by pressing the [Sensor Name] button of the Linkage Menu.

- Return to Linkage Menu

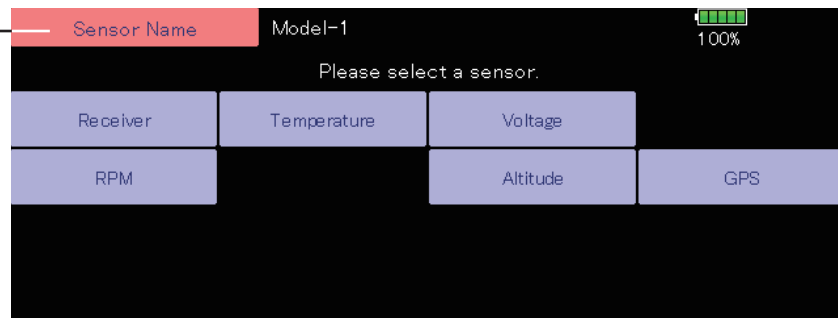

- A registered sensor unit is displayed.

GLIDER

Sensor name function

1. Touch the [Sensor Name] button in the Linkage Menu to open the setting screen. A list of sensor units is displayed.
2. Select the type of sensor unit for which the name is to be changed. A name change screen appears. When multiple sensor units of the same type are registered, the [Slot] button is displayed. Select the slot to which the sensor unit whose name is to be changed.
3. Touch the [Rename] button. A character input screen appears. Input the new name. (Up to 16 characters)
* If so desired, the sensor name can be returned to the default by pressing the [Reset] button.

HELICOPTER

Telemetry Setting

Data logging of telemetry
Turns ON/OFF the telemetry alarm



Telemetry data has been adapted to the log function which is recorded at the microSD card.

- Touch the [Telemetry Setting] button in the Linkage Menu (2/2) to call the setup screen shown below.

• To switch select screen
Turns ON/OFF the telemetry alarm.

*All telemetry alarms stop.

•Return to Linkage Menu

Telemetry Setting

Logging Switch OFF

Alarm ON/OFF Switch ON

Interval 0Sec.

Repeat INH

Duration

Setting method

1. Open the linkage menu Telemetry Log screen.
2. Log recording can be started and stopped by operating a switch. The Log Start/Stop switch is selected.
3. The log output interval can be set.

* The data to be recorded is updated at the time set by Linkage Menu→System Type screen D/L Interval. For example, when the log output interval is 1 second and the D/L interval is 2 seconds the same data is overlapped and recorded twice.

Operation method

1. Insert the microSD card into the card slot.
2. Set the switch set by Log Start/Stop Switch to ON. A beep sounds and a log file is created and recording of the telemetry data begins.

Absolutely never remove the microSD card while log data is being recorded.

3. Set the switch set by Log Start/Stop Switch to OFF. A beeping sound is generated and recording of the telemetry data stops.
4. Turn off the transmitter power and remove the microSD card.

■ Log file

A log file is created in the microSD card LOG folder. Two files with the same filename, but a different extension are created. (Example: 00001234.FLI, 00001234.FLD)

- Extension FLI: Slot allocation information file
- Extension FLD: Log data file

*When copying or moving a log file, always select both the .FLI file and .FLD file.

Log files can be converted to CSV format by using the telemetry log converter available at the Futaba website.

■Notes

- ◇ Altimeter altitude data and GPS distance and altitude data output with the point that time logging started as the reference (0 m). When the transmitter preset position and the log start position are different, the transmitter display and the log data display will also be different. The altitude and distance from the take-off position can be recorded by starting logging immediately after take-off.
- ◇ The RPM log data does not reflect the transmitter gear ratio, motor pole number or fin number setting. It is necessary to calculate the gear ratio, the number of motor poles, and the number of fins in the RPM data.
- ◇ When the microSD card becomes full, recording stops and does not resume even if logging is restarted.

AIRPLANE

GLIDER

HELICOPTER

Telemetry Alarm Duration and Repeat time

The repeat time and duration time for the telemetry alarm (buzzer and vibration) can be set.

Tap the [Telemetry Setting] button in the Linkage menu to call the setup screen shown below.

AIRPLANE

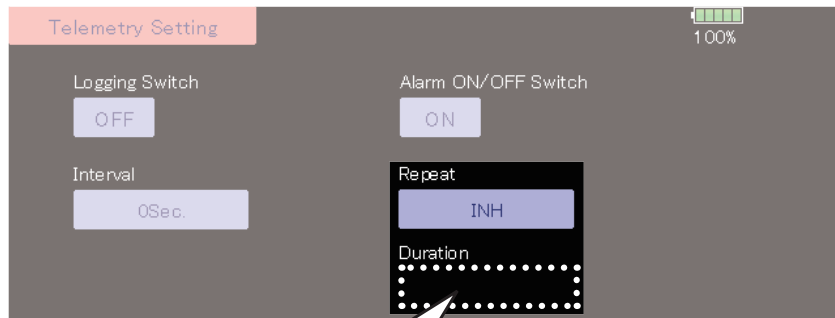

Duration is not displayed when Repeat is INH.

GLIDER

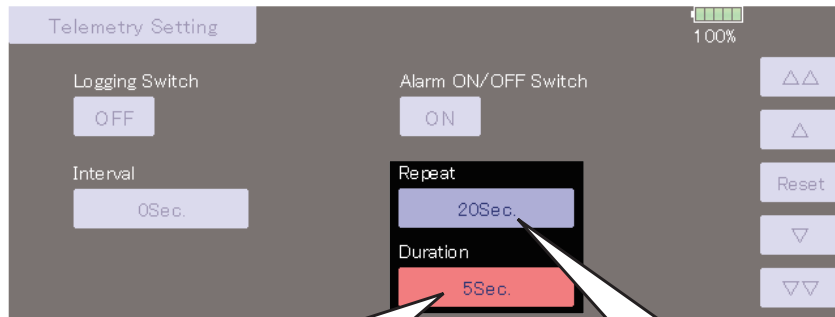

Duration

It is an alarm output time.
Setting range : 1 s ~ 30 s
Initial value : INH

Duration value has to be less than repeat value.
 Duration time is extended when the other alarm event occurs.

Repeat

It is a repeat time of an alarm output.
Setting range : INH, 1 s ~ 240 s
Initial value : INH

HELICOPTER

[Duration and Repeat time for Telemetry Alarm]

e.g. Repeat time is 8 seconds and Duration time is 5 seconds.



Warning

Setting of warning sound and vibration



A warning upon powering up your transmitter can be set up for the following functions.

Default setting is ON. Leave ON any function that you feel is dangerous upon power up. that you feel is dangerous upon power up.

The alarm is stopped at power up if the function is changed to OFF.

* If a throttle stick turns on a power supply at full throttle as in the case of the electric craft, it may begin to turn the prop at high rotation suddenly, and this is very dangerous. We recommend you set the throttle position warning to ON.

- Touch the [Warning] button in the Linkage Menu (2/2) to call the setup screen shown below.

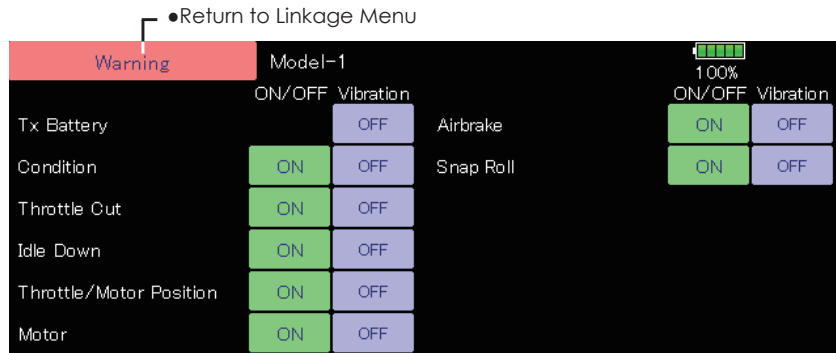

- If this is turned on, the alarm will be a vibration in the transmitter when you power on the radio.
- If this is changed to off, alarm will not sound during powering up of your transmitter.

- If a throttle stick is above low throttle when you power on your transmitter, the next screen will appear and an alarm will sound. You should never power up your transmitter with the throttle stick above fully closed for safety's sake.

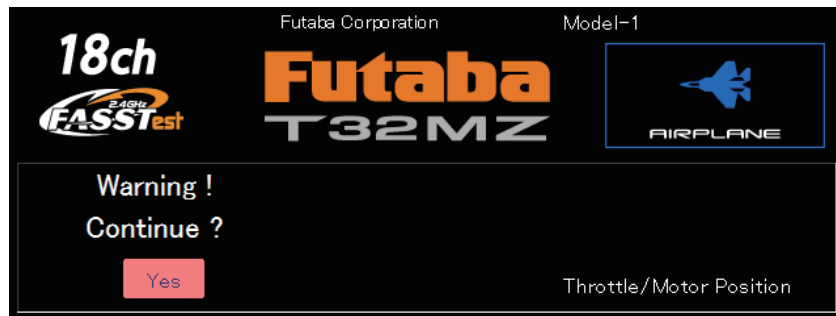

- If you lower your throttle stick when you see this warning, the confirmation screen will appear and ask if you would like to transmit. If you wish to transmit, press yes.

AIRPLANE

GLIDER

HELICOPTER

Data Reset

Model memory setting data reset. (by item)



AIRPLANE

This function is designed to allow you to reset selected portions or all of the settings saved in the active model memory. You may individually choose to reset the following sets of data;

T1~T6:

Reset the digital trim setting.

*All the conditions, or the condition currently being displayed (the entire group for group setting), can be selected.

Model menu setting:

Resets all the functions in the Model Menu except condition select.

All model setting:

Resets all Linkage and Model Menu functions except for system type, model select, and model type.

Function Name:

A function name is reset.

User Menu:

A user name is reset.

Telemetry:

A telemetry settings is reset.

- Touch the [Data Reset] button in the Linkage Menu to call the setup screen shown below.

GLIDER

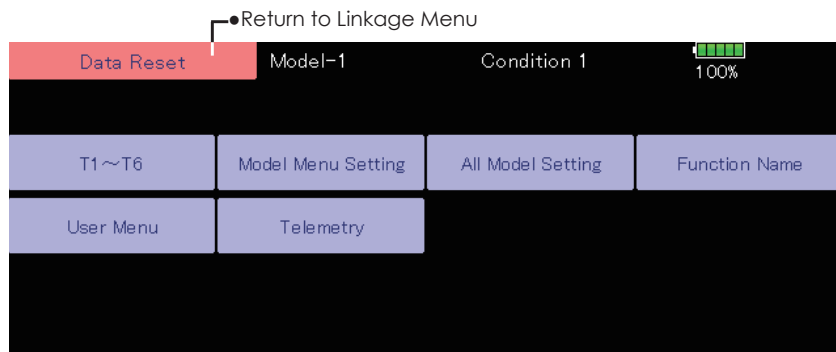

HELICOPTER

Data Resetting

1. Touch the desired button to reset the data.
2. Perform the data reset according to the instructions displayed on the screen. When complete, touch the data reset button to exit.

⚠ WARNING

- ! Default setting of the motor channel will be reversed once a reset is complete.



User Menu

T32MZ has a menu for each of the following: System, Linkage, and Model. Also, you can create a personalized User Menu that can include all of the menus that you use most often.

The User menu can be created by push the U.MENU/MON. Key.

How to make a User Menu

1. From the home screen, push and the U.MENU/MON. key.

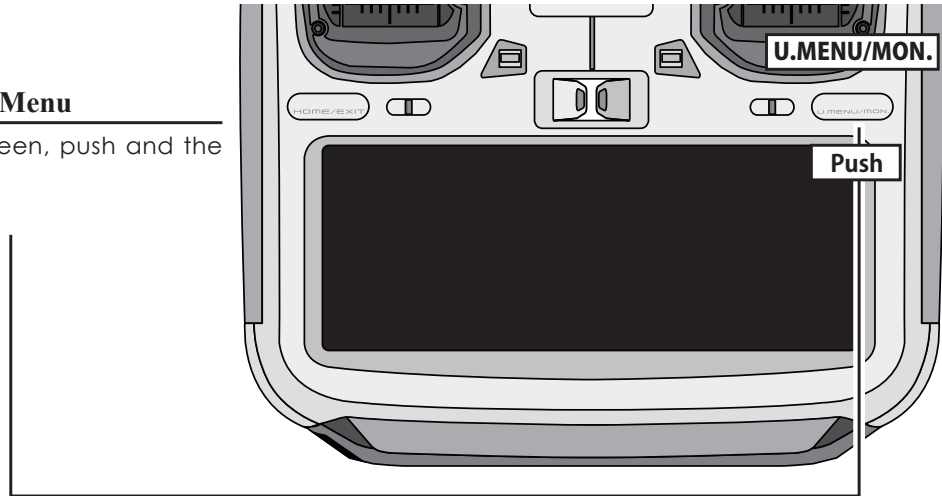

AIRPLANE

2. Touch here to select your first choice.

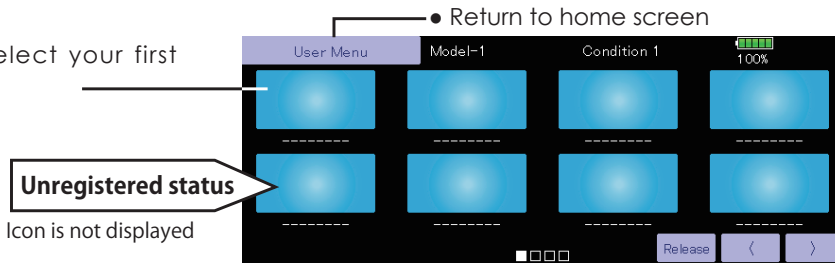

GLIDER

3. Once pressed, six pages of choices will be displayed.

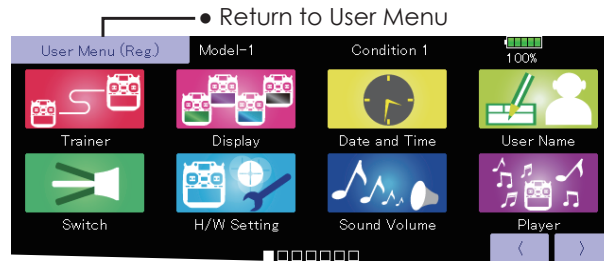

4. Make your selection, press your choice and the first of your "User Menu" will be entered.

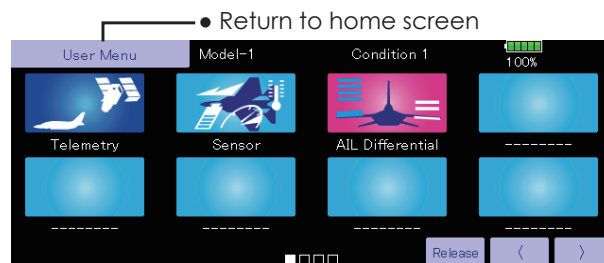

HELICOPTER

*Any change made to data entered from the User Menu or from the normal method of use are the same. Changes made in either way are saved into the transmitter memory.

- To erase a selection from your User Menu, tap the release button, then tap the menu you want to erase. This will remove it from your personal User Menu, but not from the basic menu. You can always go back at a later date and re-enter this into your User Menu.

Condition Hold

Condition hold function (Helicopter only)

This function may be used to limit the maximum speed of the engine so that you may adjust flight conditions when the engine is running. An alarm indicates that the function is operating. It will prevent the engine from racing dangerously when adjusting the Idle-Up settings.

While this function is active, the throttle servo position is fixed at the point that you have indicated when the function is activated. You must deactivate this function when you are through making adjustments.

The system will not allow you to activate/deactivate this function in either of the following states:

- When any of the flight condition switches are on.
- When the throttle stick is higher than the 1/3 point.

To activate/deactivate Condition hold:

1. Set the throttle stick lower than the 1/3 point.

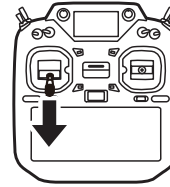

2. Push the INH button to activate the condition hold function.

*Operation is displayed at the bottom of the menu.

(LINKAGE menu or MODEL menu)

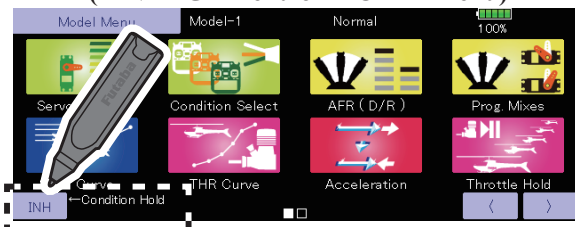

Function OFF: "INH" is displayed.

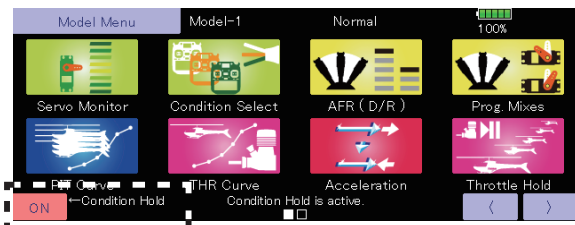

Function ON: "ON" is displayed.

MODEL MENU (COMMON FUNCTIONS)

Before setting the model data, use the Model Type function of the Linkage Menu to select the model type matched to the fuselage. When another model type is selected thereafter, the AFR, program mixing, and other setting data are reset.

The functions in the Model Menu can be set for each

flight condition. When you want to use the system by switching the settings for each condition by switch, stick position, etc., use the Condition Select function to add flight conditions. (Up to 8 conditions can be used)

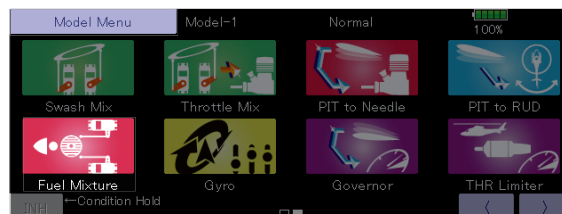
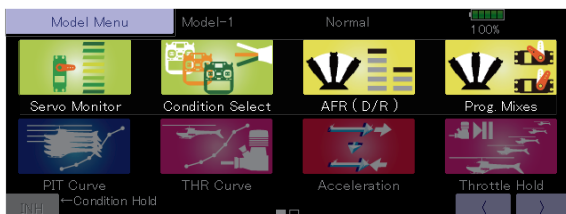

AIRPLANE

Model Menu functions (Common) table

- **Servo Monitor:** Servo test and servo position display (For a description of its functions, see the Linkage Menu section.)
- **Condition Select:** Flight conditions addition, deletion, copy, condition renaming, and condition delay can be set.
- **AFR (D/R):** Sets the rudder angle and curve of all the operation functions. A D/R curve which can be switched with a switch, etc. can also be added.
- **Prog. Mixes:** Program mixing which can be freely customized. Up to 10 mixes can be used for each condition.
- **Fuel Mixture:** Mixing used in needle adjustment of engines which use a fuel mixture control carburetor. [Airplane, helicopter]

GLIDER

HELICOPTER



Condition Select

Flight conditions addition, deletion, copy, condition renaming, and condition delay can be set. [All model types]

The functions in the Model Menu can be used by switching the settings of up to 8 flight conditions by using the Condition Select function to add flight conditions. Add conditions, as required.

When you do not want to use the Condition Select function, this setting is unnecessary. In this case, use the flight conditions (Condition 1) assigned at initial setting.

- Since switching by stick and lever position, in addition to ordinary toggle switch, is possible as the flight condition selector switch, this function can be linked with other operations.
- A Condition Delay function can be set. Unnecessary fuselage motion generated

when there are sudden changes in the servo positions and when there are variations in the operating time between channels during condition switching can be suppressed. The delay can be set for each channel.

When setting the delay function at the switching destination condition, the related function changes after a delay corresponding to the set amount.

- When multiple conditions are set, their operation priority can be freely changed.
- The condition name can be changed. The selected condition name is displayed on the screen. When a condition has been added, give it a name which can be easily confirmed.

AIRPLANE

- Touch the [Condition Select] button in the Model Menu to call the setup screen shown below.

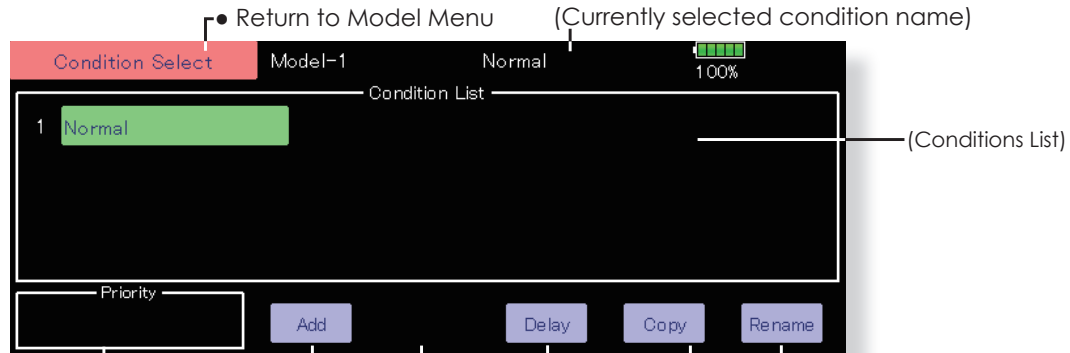

Priority change

1. Touch the condition whose priority you want to change in Conditions List.
 2. Change the priority with the priority [Δ] or [▽] button. (The last condition has the highest priority.)
- *The initial setting condition cannot be moved. It has the lowest priority.

Condition Addition

1. When the [Add] button is touched, the Condition Select screen appears.
- *Only the number of buttons corresponding to the conditions which can be added are displayed.
2. Select the desired conditions by touching the buttons.
- *The selected conditions are added to Conditions List.
3. Touch the [NULL] button to call the <Switch> screen.
 4. Select the switch to be used in condition switching.
- (For a description of the switch selection method, see next page.)
5. The "Condition 1" data for the added conditions is copied.

- Condition delay setting

(For a description of the setting method, see the next page.)

Condition Remove

1. Select the condition by touching the condition you want to reset in Conditions List.
2. Touch the [Remove] button.
3. When the [Yes] button is touched, the condition is reset. (To abort resetting, touch the [No] button.)

Condition Renaming

1. Select the condition by touching the condition you want to rename in Conditions List.
2. Touch the [Rename] button.
3. Enter the new name from the keyboard which appears on the screen.
4. When the keyboard [Return] key is touched, the new name is registered. (To abort registration, touch the [ESC] key.)

Condition Copy

1. Touch the [Copy] button. The Copy screen appears.
2. Select the condition by touching the button of the copy source conditions.
3. Next, select the condition by touching the copy destination condition.
4. Touch the [COPY] button.
5. When the [Yes] button is touched, the data is copied. (To abort copying, touch the [No] button.)

GLIDER

HELICOPTER

Condition switch setting and ON/OFF direction switching

*For a description of the selection method, see [Switch Setting Method] at the back of this manual.

- Touch the [Delay] button on the Condition Select screen to call the Condition Delay screen shown below.

• Return to Condition Select screen

(Currently selected condition name)

Condition Delay				Model-1				Normal			
Ch	Function	Delay		Ch	Function	Delay		Ch	Function	Delay	
1	Aileron	0		7	Governor	0		13	Auxiliary4	0	
2	Elevator	0		8	Governor2	0		14	Auxiliary3	0	
3	Throttle	0		9	Gyro2(AIL)	0		15	Auxiliary2	0	
4	Rudder	0		10	Gyro3(ELE)	0		16	Auxiliary1	0	
5	Gyro(RUD)	0		11	Needle	0					
6	Pitch	0		12	Auxiliary5	0					

Condition delay setting

1. Switch to the condition you want to set.
2. Touch the Delay button of the channel you want to set.
3. Use the adjustment buttons to set the delay.
 - Initial value: 0
 - Adjustment range: 0~27 (maximum delay)

Group/single mode switching (Gr./Sngl)

When setting multiple flight conditions, linking the setting contents with other conditions (Gr.) or setting independently (Sngl) can be selected. When the button is touched, it toggles between Gr. and Sngl.



*Group mode (Gr.) (initial setting): The same setting contents are set to all the flight conditions in the group mode.



*Single mode (Sngl): Select this mode when the setting contents are not linked with other conditions.

*Selecting the single (Sngl) mode at each condition after presetting in the group mode (Gr.) is convenient.



AFR (D/R)

The rudder angle and curve of each operation function can be set. A D/R curve which can be switched by switch, etc. can also be added. [All model types]

AFR function is used to adjust the throw and operation curve of the stick, lever, and switch functions (CH1 to CH16) for each flight condition. This is normally used after End Point (ATV) has defined the maximum throw directions (End Point acts on ALL flight condition settings). When mixing is applied from one channel to another channel, both channels can be adjusted at the same time by adjusting the operation rate through the AFR function.

Setting method

- Operation curve adjustment: Six types of curves (linear, EXP1, EXP2, VTR, line and spline) can be selected. A maximum 17 points curve can be used for the line and spline curve types. (Initial setting: 9 points) The number of points can also be increased and decreased and curves from complex curves to simple curves can be used.
- Operation speed adjustment: The operation speed of each function when the function is operated (including at flight condition switching) can be adjusted. The function operates smoothly at a constant speed corresponding to the set speed.

- Touch the [AFR (D/R)] button in the Model Menu to call the setup screen shown below.

(Currently selected rate name: AFR, D/R1~6)

Function selection

1. When the function select button is touched, a selection screen appears.
2. Select the function you want to set at the selection screen.

•Group/single mode switch (Gr./Sngl)
(For more information, see the description at the back of this manual.)

•Return to Model Menu (Currently selected condition name)

(Total number of AFR and D/R curves set in the currently selected condition)

•Servo speed setting
(For a description of the setting method, see the description at the back of this manual.)

•D/R function setting

Screen mode switching

When setting the D/R function, the screen display mode can be changed. Each time the button is touched, the mode is switched.

*[Sngl] (initial setting): Only the currently operating curve is displayed.

*The AFR and D/R curves set at the currently operating condition are displayed.

*[All Cond.]: The AFR curve set at all conditions is displayed.

*[Selected AFR]: The selected function is displayed.

•Operation curve setting
(For a description of the setting method, see the description at the back of this manual.)

AIRPLANE

GLIDER

HELICOPTER

Dual Rate setting

Up to six dual rates can be set for each condition.

*D/R (Dual Rate) is set for each condition, and is not reflected at other conditions.

*D/R (Dual Rate) at the top of the D/R list has priority.

Setting method

- Touch the [D/R] button from the AFR (D/R) screen of the function (ailerons, elevators, etc.) whose dual rate you want to set. The D/R list screen shown below is displayed. Touch the (function) button of the dual rate number to be assigned. That rate is automatically assigned to that function.
- Next, select the switch and its ON/OFF directions.

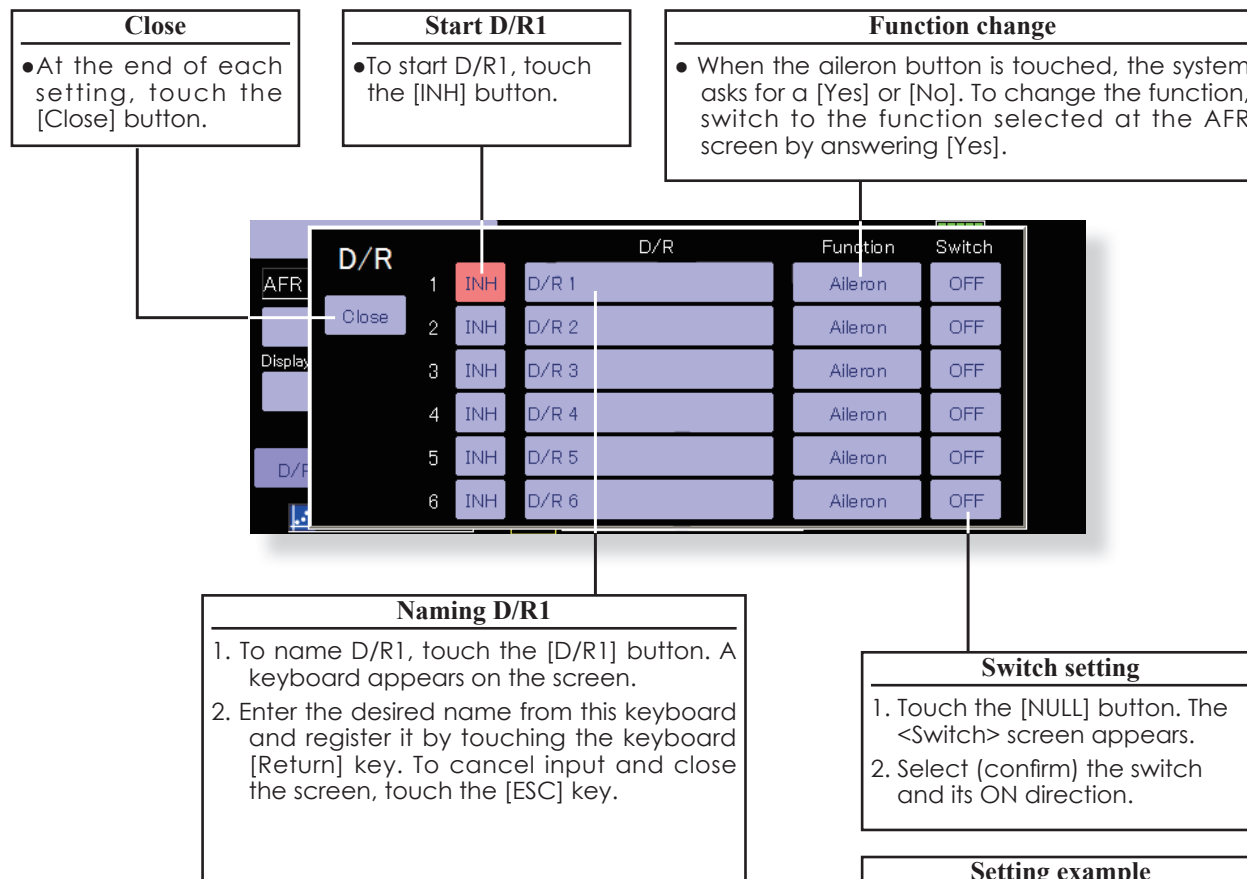

Since the functions shown below are used in special types of setups, AFR (D/R) cannot be chosen.

- *Aileron2, Aileron3, Aileron4
- *Flap2, Flap4
- *Rudder 2
- Throttle (Only helicopter)
- Pitch
- Camber
- Gyro (RUD), Gyro2 (ALL), Gyro3 (ELE)
- Governor
- Mixture
- *Elevator2
- Butterfly

*AFR (D/R) can be set up according to a wing type.

Switch setting

1. Touch the [NULL] button. The <Switch> screen appears.
2. Select (confirm) the switch and its ON direction.

Setting example

- Rudder ON/OFF by switch. When D/R is used by using the condition with the same switch, another rudder angle can be set.

AIRPLANE

GLIDER

HELICOPTER



Prog. Mixes

Program mixing which can be freely customized. Up to 10 mixings can be used for each condition. [All model types]

Programmable mixing may be used to correct undesired tendencies of the aircraft, and it may also be used for unusual control configurations. Mixing means that the motion of a command channel, called the "master," is added to the motion of the mixed channel, called "slave."

You may choose to have the Masters trim added to the Slave channel response, if you desire ("Trim" setting). The mixing curve can be changed so that the undesired tendencies can be corrected effectively by setting the LINEAR1/LINEAR2/EXP1/EXP2/VTR/LINE/SPLINE modes. The Delay function can be programmed for each rate. The Delay is used to change the rate smoothly when switching. You may define Mixing ON/OFF switch, control or you may choose to have mixing on all the time.

Offset-type mixing applies a fixed offset or preset to the programmed channel servo operation and may control up to four circuits simultaneously.

The Programmable mixing includes a powerful link function, which allows Programmable mixing to be linked with the special mixing functions, or with other programmable mixing functions. The link function can be set up for Master and Slave channel individually.

The slave channel AFR mode (STK-STK mode) may be selected, where the slave channel AFR and D/R settings are observed when Link function is set. The knob for fine tuning can be set up for every mixing circuit. (Fine tune function)

AIRPLANE

GLIDER

HELICOPTER

- Touch the [Prog. Mixes] button in the Model Menu to call the setup screen shown below.

• Return to Model Menu

• Group/single mode switching (Gr./Sngl)
(For more information, see the description at the back of this manual.)

• Mixing mode change button

(Curve-type mixing) (Offset-type mixing)

(Timer mode)

Mixing buttons
After this function is activated, the master and slave function names (or offset mixing) are displayed.

• Switch selection

• Servo speed setting

• Operation curve setting

• Fine tuning trim setting

Timer mode
The on time (start/stop time) can be set up to 35 seconds. It is useful for landing gear control of the jet or scale plane, etc.

Normal mode

Slave	Mode	ON	Offset	OFF	H/W	Fine Mode	Rate	IN	Speed	OUT	Delay Duration/Start	Stop
1 Aileron	Gr	ON	+0.0%	+0.0%	NULL		+0%	0	0	0	0.0s	0.0s
2 Aileron	Gr	ON	+0.0%	+0.0%	NULL		+0%	0	0	0	0.0s	0.0s
3 Aileron	Gr	ON	+0.0%	+0.0%	NULL		+0%	0	0	0	0.0s	0.0s
4 Aileron	Gr	ON	+0.0%	+0.0%	NULL		+0%	0	0	0	0.0s	0.0s

Setting methods Curve mixing

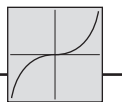

- Group/single mode selection
 - Activating functions for only the selected conditions:
 - 1. Touch the Group button and switch to the Sngl mode.
 - *Each time the button is touched, it toggles between the Gr. and Sngl modes.
- Mixing setup screen selection
 - 1. Touch the button of the mixing you want to set. The mixing setup screen is displayed. Activate the function.
 - 2. Activate the function by touching the [INH] button.
 - *Each time this button is touched, it toggles between [INH] and [ON/OFF].
- Mixing ON/OFF switch setting and ON/OFF direction switching
 - *An ON/OFF switch is not set even when the function is activated.
 - 1. When you want to turn mixing ON/OFF by switch, touch the [NULL] button to call the <Switch> screen and then select the switch and its ON direction.
 - *For a description of the selection method, see [Switch Setting Method] at the back of this manual.
- Master channel setting
 - 1. Touch the Master button to call the Function menu and select the master channel.
 - 2. To link this mixing with other mixing, touch the button at the left of the master channel and select link.
 - *Each time the button is touched, it toggles between mixing direction +, - and "No display" (no link).
 - *Master channel control can be set to stick, VR, and other simple travels which do not include ATV, AFR, D/R, mixing setting, etc. In this case, display the <Switch> screen by touching the [H/W] button and then select master channel side control.
- Slave channel setting
 - 1. Touch the Slave button to call the Function menu and select the slave channel.
 - 2. To link this mixing with other mixing, touch the button at the right-hand side of the slave channel and select link.
 - *Each time the button is pressed, it toggles between mixing direction + and - and "No display" (no link).
- Trim mode ON/OFF setting
 - 1. To turn the trim mode ON/OFF, touch the Trim button on the screen.
 - *When mixing includes master side trim, set the Trim button to [ON]. When mixing does not include master side trim, set the Trim button to [OFF].
 - *Each time this button is pressed, it toggles between [ON] and [OFF].
 - *This is effective when the master channel is set by Function.
- Slave channel AFR mode (STK→STK)
 - 1. When Link is set at the slave side, and you want to add AFR (D/R) to the mixing rate, select [ON]. When you do not want to add AFR (D/R) to the mixing rate, select [OFF].
 - *Each time this button is pressed, it toggles between [ON] and [OFF].
 - *This is effective when making corrections when the fuselage is the same but the rudder angles are substantially different.
- Mixing curve type selection
 - 1. Touch the curve type selection button of the curve type you want to use to display the selection screen and then select the curve you want to use.
 - *For a description of the curve setting method, see the description at the back of this manual.
- Fine tuning trim setting
 - 1. When using the curve fine tuning function, touch the [NULL] button of the Fine Tuning item to call the <Switch> screen and then select the lever, VR, etc. you want to use.
 - *For a description of the fine tuning trim setting method, see the description at the back of this manual.
- Servo speed setting
 - 1. When setting the servo speed, touch the Speed button. The Servo Speed setup screen is displayed.
 - *For a description of the servo speed setting method, see the description at the back of this manual.
 - *Offset mixing changes the speed. Use the Speed In and Speed Out buttons to readjust the speed.
 - The mixing switch can set a delay with a different rate at starting and stopping.
 - *This function is inactive when a mixing switch is not set.
- The programmable mixing (in mixing mode) STK to STK mixing function can be used even when the Master function is controlled by a stick or other hardware.

Setting methods : Offset mixing

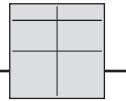

- Group/single mode selection
Activating functions for only the selected conditions:
1. Touch the Group button and switch to the Sngl mode.
*Each time the button is touched, it toggles between the Gr. and Sngl modes.

- Mixing mode selection
Using the offset mode:
1. Touch the Mode button and switch to the Offset mode.
*Each time the button is touched, it toggles between the Mix and Offset modes.



- Mixing setup screen selection
1. Touch the button of the mixing you want to set. The mixing setup screen is displayed. Activate the function.
2. Activate the function by touching the [INH] button.
*Each time this button is touched, it toggles between [INH] and [ON/OFF].

- Mixing ON/OFF switch setting and ON/OFF direction switching
*An ON/OFF switch is not set even when the function is activated.
1. When you want to turn mixing ON/OFF by switch, touch the [NULL] button to call the <Switch> screen and then select the switch and its ON direction.
*For a description of the selection method, see [Switch Setting Method] at the back of this manual.

- Slave channel setting
1. Touch the Slave button to call the Function menu and select the slave channel.
- Fine tuning trim setting
1. When using the fine tuning function, touch the [H/W:NULL] button of the Fine Tuning item to call the <Switch> screen and then select the lever, VR, etc. you want to use.
*For a description of the fine tuning trim setting method, see the description at the back of this manual.
- Servo speed setting
1. When setting the servo speed, touch the Speed button. The Servo Speed setup screen is displayed.
*For a description of the servo speed setting method, see the description at the back of this manual.

*Offset mixing changes the speed. Use the Speed In and Speed Out buttons to readjust the speed.
The mixing switch can set a delay with a different rate at starting and stopping.
*This function is inactive when a mixing switch is not set.

- Delay selection
Using the normal mode:

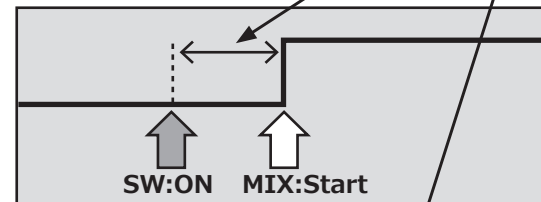
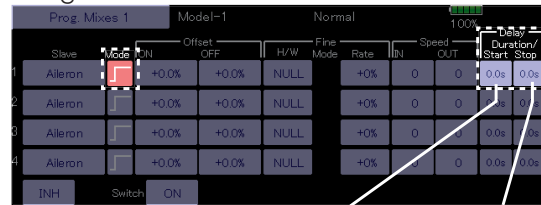

(S) →

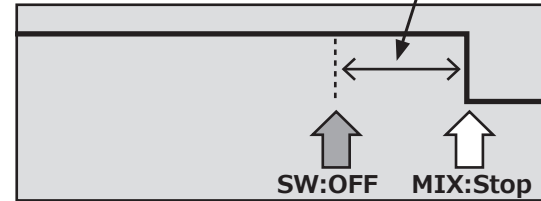

(S) →

- Delay selection
Using the timer mode:

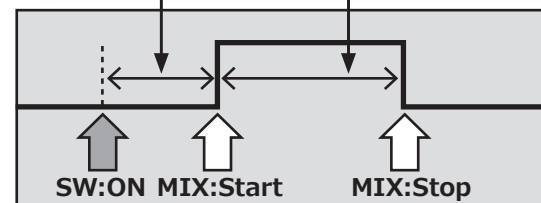
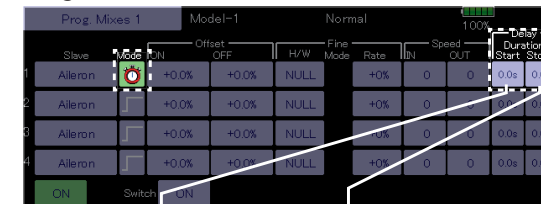

(S) →

Fuel Mixture

Dedicated mixing used in needle adjustment of engines which use a fuel mixture control carburetor. [Airplane, helicopter]

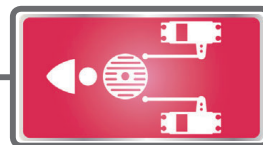

This function is dedicated mixing used in needle adjustment of an engine that uses a fuel mixture control carburetor.

*The needle channel is assigned to CH9 as a default.

- Touch the [Fuel Mixture] button in the Model Menu to call the setup screen shown below.



- Operation curve setting
(For a description of the setting method, see the description at the back of this manual.)

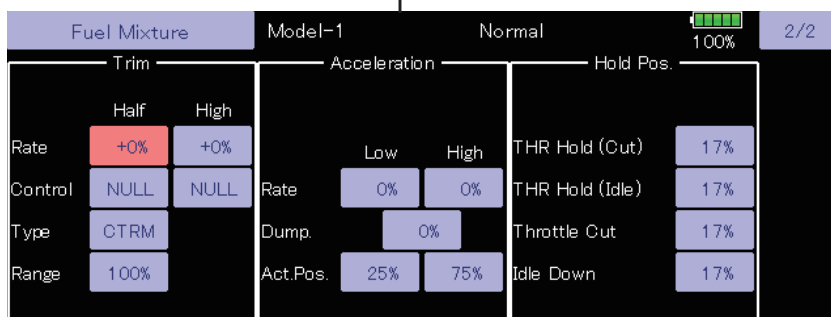

Setting method

CTRM mode: Maximum change near center by center trim operation (Does not change at end of the stick movement) When the adjustment range (Range) value is made small, trim is active only near the center.

NORM mode: Normal trim (linear) operation. When the adjustment range value is decreased, trim is active only near the center. Needle high trim works as high trim based on the center. This operation is similar to reverse ATL trim.

1. An acceleration function can be set. This is used when the mixture is either too rich or too lean, which can be caused by sudden operation of the throttle stick.
2. The return time after operation (Dump) can be set for both settings (Acceleration-High).

3. A needle throttle cut function can be set.
4. This operation can be linked with the throttle hold functions (Cut and Idle), Throttle Cut function, and Idle Down.
5. The needle side cut position can be set. Set it to the fuel side full open position.
When **MIX** mode is selected, the throttle curve setting becomes the master.
In the **UNMIX** mode, the throttle stick position becomes the master.

AIRPLANE

GLIDER

HELICOPTER

MODEL MENU (AIRPLANE/GLIDER FUNCTIONS)

These are the menus usable when either airplane, glider, or EP glider model type have been selected, and displayed in the Model Menu screen. First use the Model Type function of the Linkage Menu to select your model type, wing type, and tail type. Changing these later will reset any data set in this menu.

condition, as required. When you want to use the system by switching the settings for each condition by switch or stick position, use the Condition Select function to add flight conditions. (Up to eight conditions can be used)

These dedicated mixings can be set for each flight

AIRPLANE

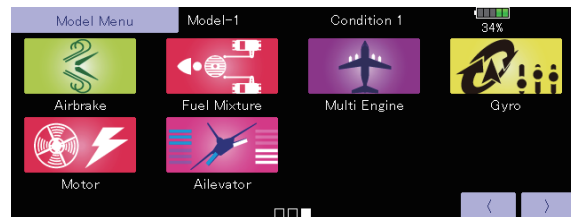
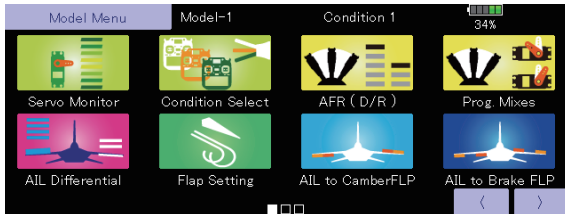

(Model Menu screen example)

*The Model Menu screen depends on the model type. This screen is for model type Airplane Wing Type 4AIL+4FLP.

GLIDER

Model Menu functions (AIRPLANE/GLIDER) table

- AIL Differential:** This function adjusts the left and right ailerons. Roll axis correction and fine tuning with a VR are also possible. This is convenient when making settings during flight.
 [Airplane/glider, 2 ailerons or more]
- Flap Setting:** The flaps can be adjusted independently. For a 4 flaps model, the camber flaps can be mixed with the brake flaps.
 [Airplane/glider, 2 flaps or more]
- AIL to Camber FLP:** This mixing operates the camber flaps in the aileron mode. It improves the operation characteristic of the roll axis.
 [Airplane/glider, 2 ailerons + 2 flaps or more]
- AIL to Brake FLP:** This mixing operates the brake flaps in the aileron mode. It improves the operation characteristic of the roll axis.
 [Airplane/glider, 4 flaps or more]
- AIL to RUD:** This mixing is used when you want to operate the rudder with aileron operation. Banking at a shallow bank angle is possible.
 [Airplane/glider, 2 ailerons + 2 flaps or more]
- Airbrake to ELE:** This mixing is used to correct operation of the airbrakes (spoilers) when landing.
 [Airplane/glider, general]
- RUD to AIL:** This mixing is used to correct roll maneuvers, knife edge, etc. of stunt planes.
 [Airplane/glider, general]
- Camber Mix:** This mixing adjusts the camber and corrects the elevators.
 [Airplane/glider, 2 ailerons or more]
- ELE to Camber:** This mixing is used when you want to the mix camber flaps with elevator operation. Lift can be increased with raised elevators.
 [Airplane/glider, 2 ailerons or more]

- **Camber FLP to ELE:** This mixing is used to correct for attitude changes when the camber flaps are being used.
[Airplane/glider, 2 ailerons + 1 flap or more]
- **Butterfly (Crow):** This function is used when powerful brake operation is necessary.
[Glider, 2 ailerons or more]
- **Trim Mix 1/2:** The ailerons, elevators, and flaps trim offset rate can be utilized by a switch or condition selection.
[Glider, 2 ailerons or more]
- **Airbrake:** This function is used when airbrakes are necessary when landing or when diving during flight.
[Airplane, general]
- **Gyro:** This is dedicated mixing when a gyro is used. [Airplane/glider, general]
- **V-tail:** This function adjusts the elevators and rudder of V-tail models.
[Airplane/glider, V-tail specifications]
- **Ailevator:** This function adjusts the elevators and ailerons of models with elevator specifications.
[Airplane/glider, elevator specifications]
- **Winglet:** This function adjusts the left and right rudders of winglet models.
[Airplane/glider, winglet specifications]
- **Motor:** The operation speed when the motor of F5B and other EP gliders is started by switch can be set.
[EP glider, general]
- **RUD to ELE:** This function is used to correct roll maneuvers, knife edge, etc. of stunt planes.
[Airplane, general]
- **Snap roll:** This function selects the snap roll switch and adjusts the steering angle of each rudder. Servo speed can also be adjusted.
[Airplane general]
- **Multi Engine:** This function adjusts the throttles independently when using a multi engine model. (Maximum four engines)
[Airplane, general]
- **Acceleration:** Acceleration setting can be performed at elevator, ELE to Camber and AIL to RUD.
[Glider/EP glider]

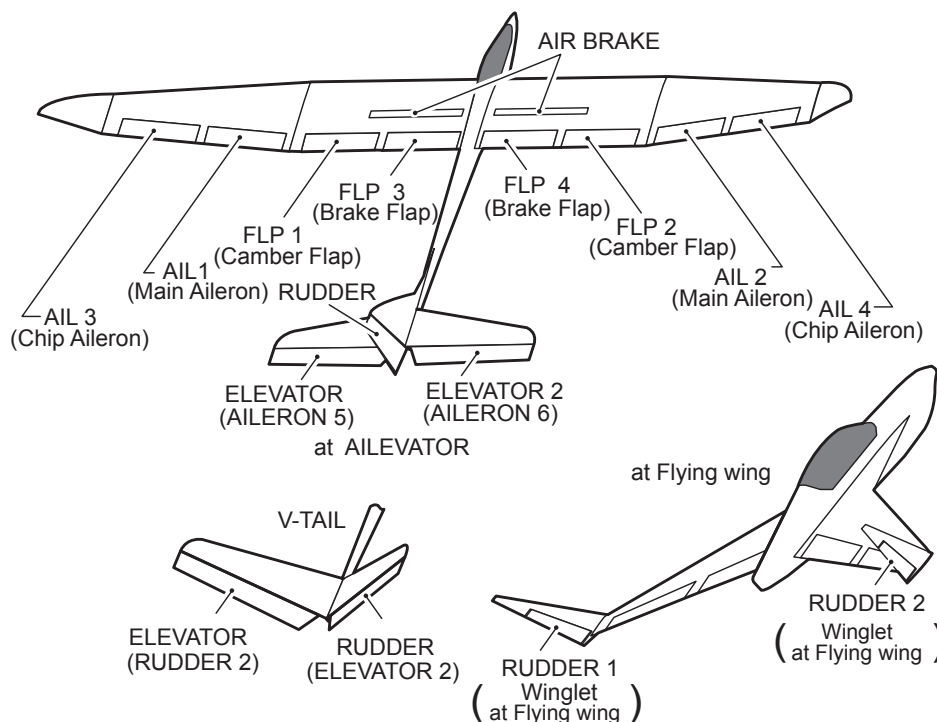

AIL Differential

[Corresponding model type]: Airplane/
glider, 2 ailerons or more



The left and right ailerons differential can be adjusted independently. The differential rate can also be adjusted according to the flying state by setting a fine tuning VR.

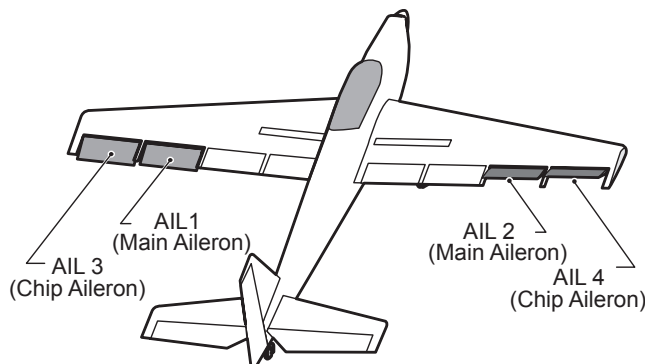

- A fine tuning curve can be set.
Note: Aileron up/down setting (%) reset is +100% when reset when setting is +, and -100% when reset when setting is -. Left and right mixing causes + and - to change. Before flying, confirm the direction of operation.

AIRPLANE

- Touch the [AIL Differential] button in the Model Menu to call the setup screen shown below.

<Wing type: 4 ailerons screen>

*The display screen is an example. The actual screen depends on the Model Type.

- Calls the AFR screen directly when adjusting aileron operation AFR.

AIL Differential

	Left	Right
AIL	100%	100%
AIL2	100%	100%
AIL3	100%	100%
AIL4	100%	100%
Fine Tuning		NULL

Model1 Condition 1

POS: +0.0% RATE: +0.0%

Linear Separate

Rate A Rate B

+100.0% +100.0%

Offset Xoffset

+0.0% +0.0%

Master 87%

• Return to Model Menu

• Aileron left/right adjustment
*The display is reversed by mixing with aileron operation

• Fine tuning VR setting
*The graph is operated by setting a VR, etc.

• Fine tuning curve setting
(For a description of the setting method, see the description at the end of the manual.)

• Overall adjustment by RateA and RateB.

• Group/single mode switching (Gr./Sngl)
(For more information, refer to the description at the back of this manual.)

GLIDER

Setting method

- Touch the aileron (AIL) 1~4 left (or right) button, and adjust the aileron angles when the stick is moved to the left (or right) end.
- *The aileron AFR screen can be directly selected from the AIL Differential setup screen. ([Master] button)
- When setting the fine tuning VR, touch the "NULL" button to call the <Switch> screen, and then select the fine tuning VR.
- The fine tuning rate can be set by curve.

Flap Setting

[Corresponding model type]: Airplane/
glider, 2 flaps or more



The up/down travel of each flap (camber flaps: FLP1/2, brake flaps: FLP3/4) can be adjusted independently at each servo according to the wing type.

- The operation reference point of each flap can be offset

The camber flaps of a 4-flap model can be mixed with the brake flaps. (Brake FLP to camber FLP)

- An ON/OFF switch can be set.

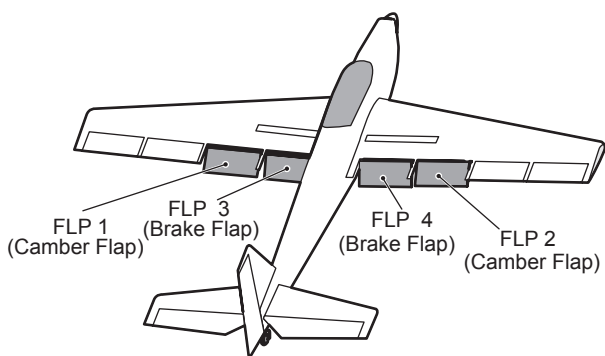

- Touch the [Flap Setting] button in the Model Menu to call the setup screen shown below.

<Wing type: 4 flaps screen>

*The display screen is an example. The actual screen depends on the model type.

- Group/single mode switching (Gr./Sngl)
(For more information, see the description at the back of this manual.)

•Return to Model Menu

Flap Setting		Model1	Condition 1	87%
Camber Flap		Brake Flap		B.Flap to C.Flap
Group		Group		ACT
	FLP FLP2		FLP3 FLP4	INH
Up	+100% +100%	Up	+100% +100%	ON
Down	+100% +100%	Down	+100% +100%	+100%
Offset	+0% +0%	Offset	+0% +0%	+100%
				Offset
				+0%

•Operation reference point offset

•Up side/Down side adjustment

Setting method

- Touch the flap (FLP) 1~4 Up or Down button according to the wing type and adjust the travel independently.
- To offset the operation reference point of each flap, touch the corresponding Offset button. Use the adjustment buttons displayed on the screen to offset the reference point.
- When using Brake FLP to Camber FLP mixing, touch the ACT button and set the function to ACT (ON). When setting a switch, touch the [ON] button of the switch to call the <Switch> screen, and then select the switch and set its ON direction. (Always ON at "ON" setting)
(For a description of the switch selection method, see the description at the back of this manual.)

AIRPLANE

GLIDER

AIL to Camber FLP [Corresponding model type]: Airplane/ glider, 2 ailerons + 2 flaps or more



This mixing operates the camber flaps (FLP1/2) in the aileron mode. When the aileron stick is manipulated, the ailerons and camber flaps move simultaneously and the roll axis is improved.

- The aileron left/right mixing rate of each flap servo can be fine-tuned.
- A mixing curve can be set.
- An ON/OFF switch can be set.
- Linking to other mixes is possible.

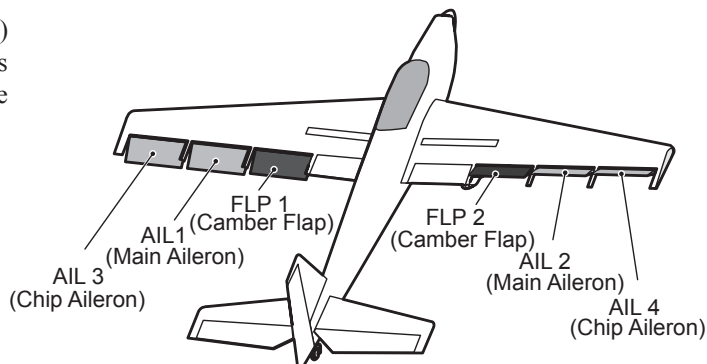

AIRPLANE

- Touch the [AIL to Camber FLP] button in the Model Menu to call the setup screen shown below.

*The display screen is an example. The actual screen depends on the model type.

• Return to Model Menu

• Left/right overall adjustment at RateA and RateB

• Adjustment of each flap servo

• Mixing curve setting (For a description of the curve setting method, see the description at the back of this manual.)

• Group/single mode setting (Gr./Sngl) (For more information, see the description at the back of this manual.)

GLIDER

Setting method

- Touch the ACT button and set the function to ACT (ON).
- When setting a switch, touch the [ON] button of the switch to call the <Switch> screen, and then select the switch and set its ON direction. (Always ON at "ON" setting) (For a description of the switch selection method, see the description at the back of this manual.)
- Touch the left or right button of each flap servo, and adjust the mixing rate with the adjustment buttons.

*When the mixing direction is reversed due to linkage setup, adjustments can be made by changing the rate value from + to - (positive to negative).

- A mixing curve can be set. (For a description of the mixing curve setting method, see the description at the back of this manual.)
- To set linking, touch the Link button and set it to ON.

AIL to Brake FLP

[Corresponding model type]: Airplane/
glider, 4 flaps or more



This mixing operates the brake flaps (FLP3/4) in the aileron mode. When the aileron stick is manipulated, the aileron and brake flaps perform the aileron operation simultaneously and the performance of the roll axis is improved.

- The aileron left and right mixing rates can be adjusted for each flap servo.
- A mixing curve can be set.
- Mixing during flight can be turned ON/OFF by setting a stick. (Always ON at "ON" setting)
- Linking can be set: Links this mixing to other mixings.

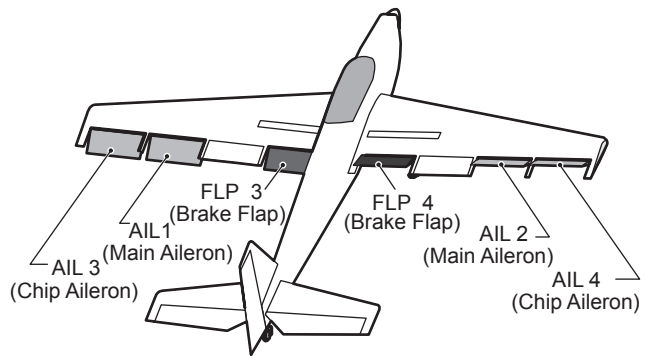

AIRPLANE

- Touch the [AIL to Brake FLP] button in the Model Menu to call the setup screen shown below.

*The display screen is an example. The actual screen depends on the model type.

GLIDER

Setting method

- Touch the ACT button and set the function to ACT (ON).
- When setting a switch, touch the [ON] button of the switch to call the <Switch> screen, and then select the switch and set its ON direction. (Always ON at "ON" setting)
- Touch the left or right button of each flap servo, and adjust the mixing rate with the adjustment buttons.

*When the mixing direction is reversed due to linkage setup, adjustments can be made by changing the rate value from + to - (positive to negative).

- A mixing curve can be set.
- To set linking, touch the Link button and set it to ON.



AIL to RUD [Corresponding model type]: Airplane/ glider, general

Use this mixing when you want to mix the rudders with aileron operation.

- A mixing curve can be set.
- Mixing during flight can be turned ON/OFF by setting a switch. (Always ON at "ON" setting)
- The mixing rate can be fine-tuned by setting a VR.

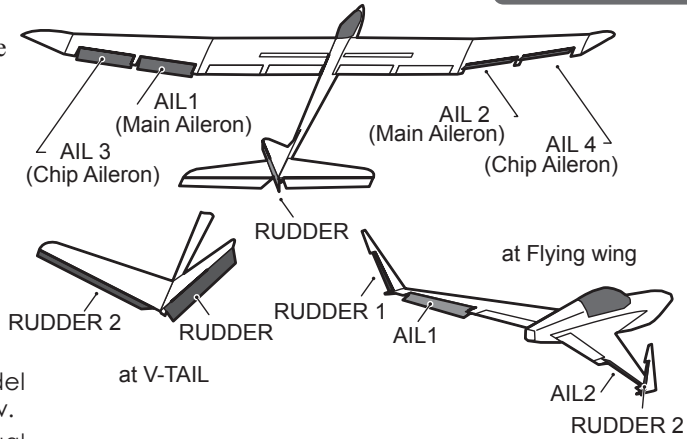

- Touch the [AIL to RUD] button in the Model Menu to call the setup screen shown below.
- *The display screen is an example. The actual screen depends on the model.

• Return to Model Menu

• Left/right overall adjustment by RateA and RateB

• Fine tuning VR setting

• Mixing curve setting

• Group/single mode setting (Gr./Sngl)

• Curve display mode selection (Single/Fine tuning/All Cond.)

AIRPLANE

GLIDER

Setting method

- Touch the ACT button and set the function to ACT (ON).
- When setting a switch, touch the [ON] button of the switch to call the <Switch> screen, and then select the switch and set its ON direction. (Always ON at "ON" setting)
- When setting a VR, touch the Fine Tuning "NULL" button to call the <Switch> screen, and then select the VR. The adjustment rate and direction can be set. The VR operation mode can also be selected.
- A mixing curve can be set.
- The curve display mode can be changed.
Single : Displays the mixing curve only
Fine tuning : Displays the mixing rate of the fine tuning VR
All Cond. : Displays the mixing curve of all the conditions. (When conditions are set)

Fine tuning VR setting

• VR selection

• Rate adjustment

• Operation mode selection
*Displayed at VR setting.

• Adjustment direction setting

[Operation modes]

- Mixing rate 0% at center of VR
When the VR is turned counterclockwise and clockwise, the mixing rate increases and decreases, respectively.
- Mixing rate 0% at left end of VR
When the VR is turned, the mixing rate increases.
- Mixing rate 0% at right end of VR. When the VR is turned, the mixing rate increases.
- When the VR is turned to the left or right of the neutral position, the mixing rate increases.

Airbrake to ELE

[Corresponding model type]: Airplane/glider, general



This mixing is used when you want to mix the elevators with airbrake (spoiler) operation. It raises the elevators to correct for drooping of the nose during airbrake operation.

*This function does not operate when airbrake is not assigned.

- Rate1 side/Rate2 side mixing rate of the elevator servos can be adjusted.
- A mixing curve can be set.
- Mixing during flight can be turned ON/OFF by setting a switch. (Always ON at "ON" setting)
- The mixing rate can be fine-tuned by setting a VR.

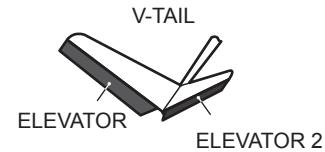

- Touch the [Airbrake to ELE] button in the Model Menu to call the setup screen shown below.

AIRPLANE

GLIDER

Setting method

- Touch the "INH" button and set the function to ACT (ON).
- When setting a switch, touch the [ON] button to call the <Switch> screen, and then select the switch and set its ON direction. (Always ON at "ON" setting)
- When setting a VR, touch the Fine tuning "NULL" button to call the <Switch> screen, and then select the VR. The adjustment rate and direction can be set. The VR operation mode can also be set.
- A mixing curve can be set.
- The curve display mode can be set.
 Single : Displays the mixing curve only
 Fine tuning : Displays the adjustment rate of the fine tuning VR.
 All Cond. : Displays the mixing curve of all the conditions. (When conditions are set)

RUD to AIL

[Corresponding model type]: Airplane/glider, general



This function is used when you want to mix the ailerons with rudder operation. It is used when rudder is applied during roll maneuvers, knife edge, etc. of stunt planes. It can be used to scale models, large models, etc. like a full size plane.

When the memory mode is exited, the memorized points are automatically reflected on the curve. (When the memory function is used, "Line" type curve is automatically selected.)

- Linking can be set: Links this mixing to other mixings.
- The mixing rate can be fine-tune by setting a VR.

AIRPLANE

- A mixing curve can be set.
- Mixing during flight can be turned ON/OFF by setting a switch. (Always ON at "ON" setting)
- The rate of rudder correction can be memorized by using the memory function. This is convenient when setting a mixing curve. When memory operation (switch operation) is performed in memory mode with the rudder correction, the switch operation position at that time is displayed on the mixing curve.

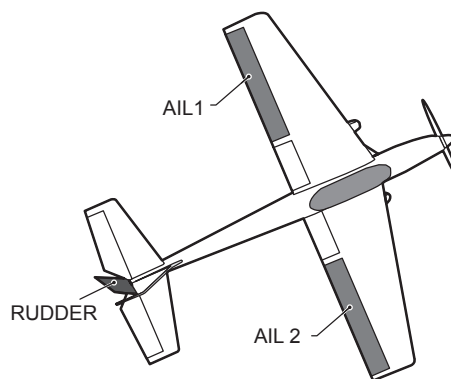

- Touch the [RUD to AIL] button in the Model Menu to call the setup screen shown below.

GLIDER

Setting method

- Touch the "INH" button and set the function to ACT (ON).
- When setting a switch, touch the [ON] button to call the <Switch> screen, and then select the switch and set its ON direction. (Always ON at "ON" setting)
- When setting a VR, touch the Fine tuning "NULL" button to call the <Switch> screen and then select the VR. The adjustment rate and adjustment direction can be set. The VR operation mode can also be set.
- A mixing curve can be set.
- The curve display mode can be changed.
 - Single : Displays the mixing curve only.
 - Fine tuning : Displays the adjustment rate of the fine tuning VR.
 - All Cond. : Displays the mixing curve of all the conditions. (When conditions are set)
- When linking: Touch the Link button and set it to ON.

Camber Mix

[Corresponding model type]: Airplane/
glider, 2 ailerons or more



This function adjusts the AFR (D/R) rate of camber operation which operates the wing camber (ailerons, camber flaps, brake flaps) in the negative and positive directions. The aileron, flap, and elevator rates can also be adjusted independently by curve, and attitude changes caused by camber operation can be corrected.

*Initial setting assigns camber operation to side lever RST (Stick Mode 2) LST (Stick Mode 1).

- The direction of the aileron, flap, and elevator servos can be adjusted by a curve. When direction is reversed at the linkage by this mix, you can reverse it by changing the rates to either + or - (positive or negative).
- Mixing during flight can be turned ON/OFF by setting a switch. (Always ON at "ON" setting)
- A delay can be set for each condition. A cut switch which can turn OFF the delay function can be set.
- The speed of the aileron, flap, and elevator servos can be set. (IN side/OUT side)

- Touch the [Camber Mix] button in the Model Menu to call the setup screen shown below.

*The display screen is an example. The actual screen depends on the model type.)

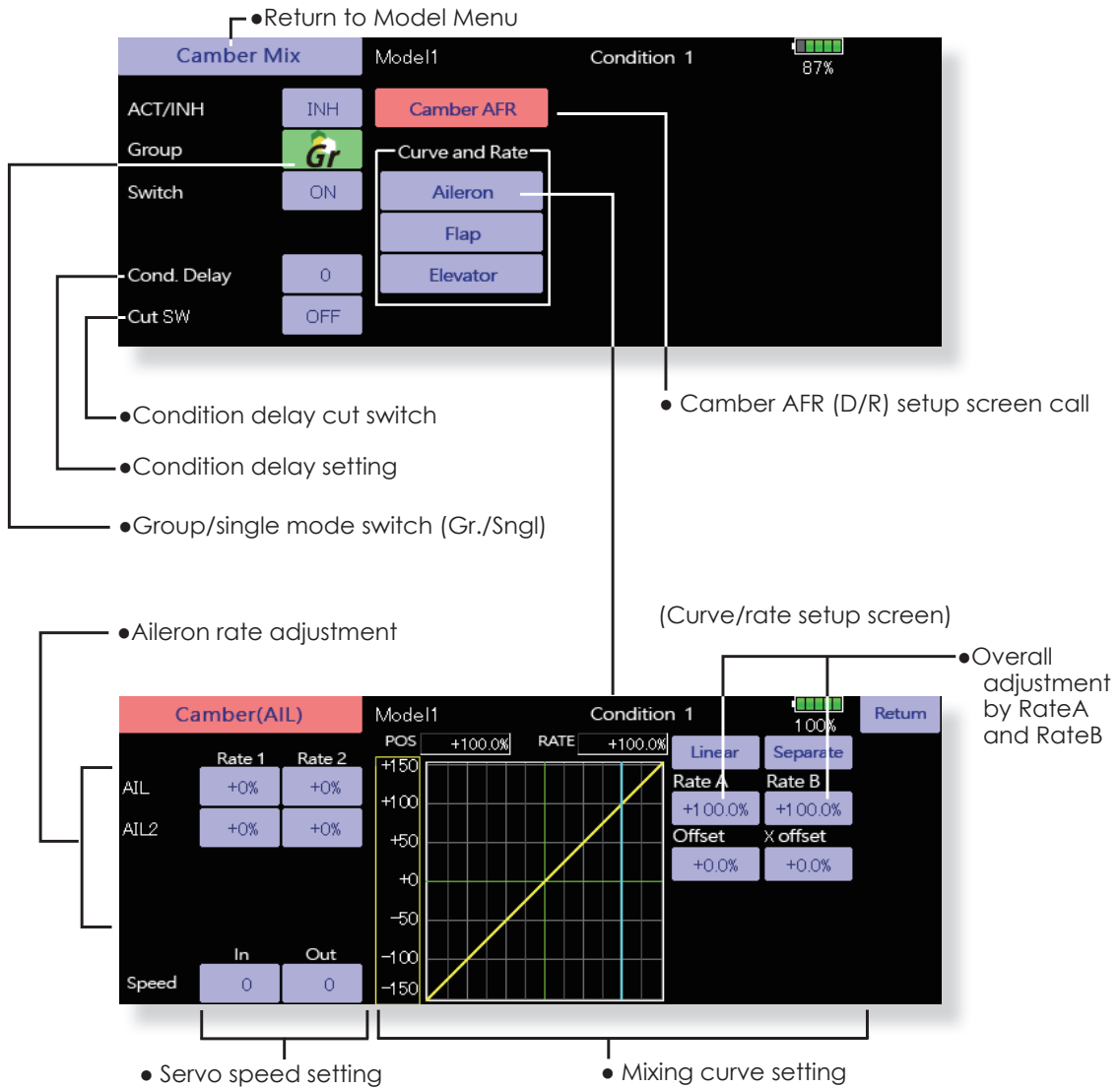

AIRPLANE

GLIDER

Setting method

- Touch the "INH" button and set the function to ACT (ON).
- When setting a switch, touch the [ON] button to call the <Switch> screen, and then select the switch and set its ON direction. (Always ON at "ON" setting)
- When setting a condition delay, touch the Condition Delay button and set the delay with the adjustment buttons which appear on the screen.
The VR operation mode can also be set.
- Camber AFR (D/R) screen call
Touch the Camber AFR button to call the setup screen.

(Curve/rate setup screen)

- The curve and rate are adjusted by calling the aileron, flap, and elevator curve/rate screens. The rate and curve of each servo can be set by calling each screen. The servo speed can also be adjusted.

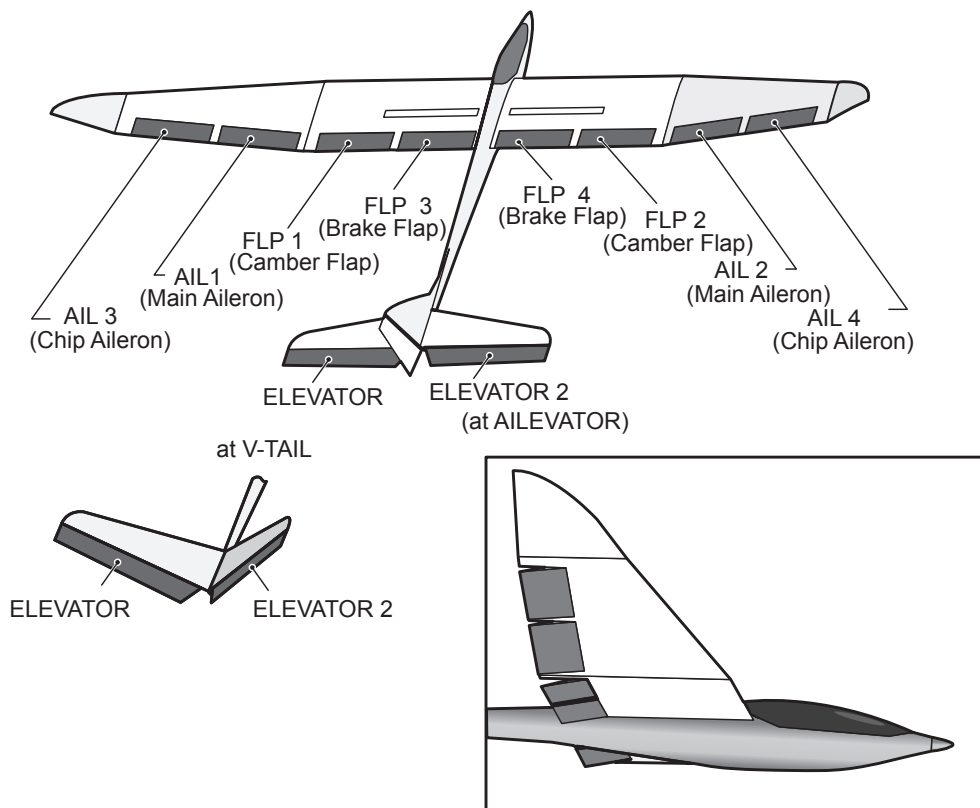

ELE to Camber

[Corresponding model type]: Airplane/
glider, 2 ailerons or more



This function is used when you want to mix the camber flaps with elevator operation. When mixing is used so that the flaps are lowered by up elevator, lift can be increased.

- A mixing curve can be set.
- Mixing during flight can be turned ON/OFF by setting a switch. (Always ON at "ON" setting)
- The mixing rate can be fine-tuned by setting a VR.

- Touch the [ELE to Camber] button in the Model Menu to call the setup screen shown below.
- Curve display mode switching (Single/Fine tuning/All Cond.)
- Return to Model Menu
- Group/single mode switching (Gr./Sngl)
- Overall adjustment by RateA and RateB
- Fine tuning VR setting
- Mixing curve setting

ELE to Camber		Model1				Condition 1			
		AIL3	AIL	AIL2	AIL4				
Rate 1	+0%	+0%	+0%	+0%	+0%	(+0%)	(+0%)	(+0%)	(+0%)
Rate 2	+0%	+0%	+0%	+0%	+0%	(+0%)	(+0%)	(+0%)	(+0%)
		FLP3	FLP	FLP2	FLP4				
Rate 1	+0%	+0%	+0%	+0%	+0%	(+0%)	(+0%)	(+0%)	(+0%)
Rate 2	+0%	+0%	+0%	+0%	+0%	(+0%)	(+0%)	(+0%)	(+0%)

(Ailerons and flaps rate adjustment screen)

Setting method

- Touch the ACT button and set the function to ACT (ON).
- When setting a switch, touch the [ON] button of the switch to call the <Switch> screen, and then select the switch and set its ON direction. (Always ON at "ON" setting.)
- When setting a VR, touch the Fine tuning "NULL" button to call the <Switch> screen, and then select the VR. The adjustment rate and adjustment direction can be set. The VR operation mode can also be selected.
- A mixing curve can also be set.
- The curve display mode can be changed.
Single : Displays the mixing curve only
Fine tuning : Displays the fine tuning VR adjustment rate.
All Cond. : Displays the mixing curve of all the conditions (When conditions are set).

AIRPLANE

GLIDER

Camber FLP to ELE

[Corresponding model type]: Airplane/
glider, 2 ailerons + 1 flap or more



This mixing is used to correct changes (elevator direction) generated when the camber flaps (speed flaps) are used.

- The elevator servo rates can be adjusted. When the mix cause the servo direction to be reversed, adjustments can be made by changing the mixing rates at - to + (negative to positive).
- A mixing curve can be set.
- Mixing during flight can be turned ON/OFF by setting a switch. (Always ON at "ON" setting)
- The mixing rate can be fine-tuned by setting a VR.

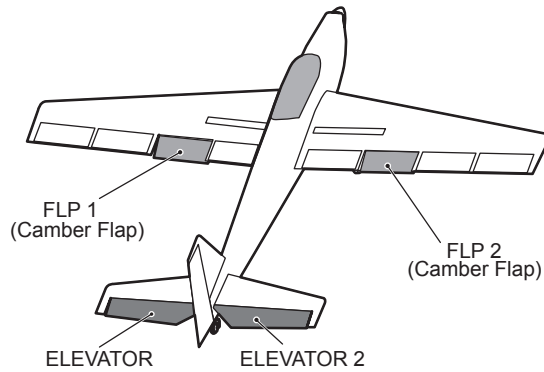

AIRPLANE

- Touch the [Camber FLP to ELE] button in the Model Menu to call the setup screen shown below.
- *The display screen is an example. The actual screen depends on the model type.
- Group/single mode switching (Gr./Sngl)

GLIDER

Setting method

- Touch the ACT button and set the function to ACT (ON).
- When setting a switch, touch the switch button to call the <Switch> screen, and then select the switch and set its ON direction. (Always ON at "ON" setting)
- Touch the elevator servos left and right buttons and adjust the mixing rate with the adjustment buttons displayed on the screen.
- *When the mixing direction is reversed due to linkage setup, adjustments can be made by changing the rate value from + to - (positive to negative).
- When setting a VR, touch the Fine tuning "NULL" button to call the <Switch> screen, and then select the VR. The VR operation mode can be selected.
- A mixing curve can be set.
- The curve operation mode can be changed.
 - Single : Displays only the mixing curve
 - Tune : Displays the adjustment rate of the fine tuning VR.
 - All Cond. : Displays the mixing curve of all the conditions (when conditions are set).



Butterfly

[Corresponding model type]: Glider,
2 ailerons or more

This function allows powerful brake operation by simultaneously raising the left and right ailerons and lowering the flaps (camber flap, brake flap).

Butterfly (Crow) produces an extremely efficient landing configuration by accomplishing the following:

1. Slowing the aircraft's velocity.
2. Providing washout at the wing tips to reduce the tendency to tip stall.
3. Creating more lift toward the center of the wing allowing it to fly at a slower speed.

- Mixing during flight can be turned ON/OFF by setting a switch. (Always ON at "ON" setting)
 - The ailerons, flaps, and elevators operation speed can be adjusted. (IN side/OUT side)
 - A delay can be set for each condition. A cut switch which can turn OFF the delay function can also be set.
 - The differential rate can be adjusted.
- *When servo binding occurs when setting the ailerons and flaps in butterfly mixing, use the AFR function to adjust the rudder angle.

- Touch the [Butterfly] button in the Model Menu to call the setup screen shown below.
(The display screen is an example. The actual screen depends on the model type. The screen shown below is for 4 ailerons and 4 flaps.)
- Touch the ACT button and set the function to ACT (ON).
- When setting a switch, touch the SWITCH [ON] button to call the <Switch> screen, and then select the switch and set its ON direction.

- To set the offset point for butterfly move the flap stick to the position where you want your butterfly settings to become active. Push the [Offset] button to set that point. The reference point displays 0%. When [Yes] is touched, the reference point is changed. Then, is "Initialized elevator curve?" is heard, it chooses in which.

- Group/single mode switching (Gr./Sngl)

- Touch the Mixing RateAIL and FLP buttons and adjust the mixing rates.

The screenshot shows the Butterfly setup screen for Model1, Condition 1. The screen is divided into several sections:

- Left Column:** ACT (INH), Group (Gr), Switch (ON), Offset (15%), Cond. Delay (0), Delay (0), Cut SW (OFF).
- Speed Section:** In (0), Out (0) for both AIL and FLP.
- Mixing Rate Section:** AIL3 (+0%), AIL (+0%), AIL2 (+0%), AIL4 (+0%), FLP3 (+0%), FLP (+0%), FLP2 (+0%), FLP4 (+0%).
- Differential Rate Section:** +, 0%.
- Bottom Right:** Butterfly AFR, ELE Setting.

Callouts from the text explain the following settings:

- Return to Model Menu (points to the Butterfly button)
- Aileron and flap servos speed setting (points to the Speed section)
- Differential rate adjustment (points to the Differential Rate section)
- To elevator correction setup screen. It is not displayed in a flying wing. (points to the Butterfly AFR and ELE Setting buttons)
- Condition delay setting and cut switch setting (points to the Cond. Delay, Delay, and Cut SW buttons)
- Group/single mode switching (Gr./Sngl) (points to the Group button)
- Touch the Mixing RateAIL and FLP buttons and adjust the mixing rates. (points to the Mixing Rate section)

GLIDER

- Touch the ELE correction rate buttons and adjust the rates with the adjustment buttons displayed on the screen.

((ELE Setup) screen)

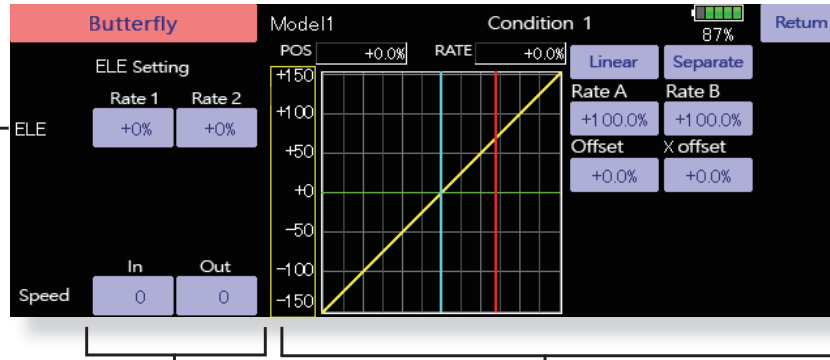

• Servo speed setting

• Mixing curve setting

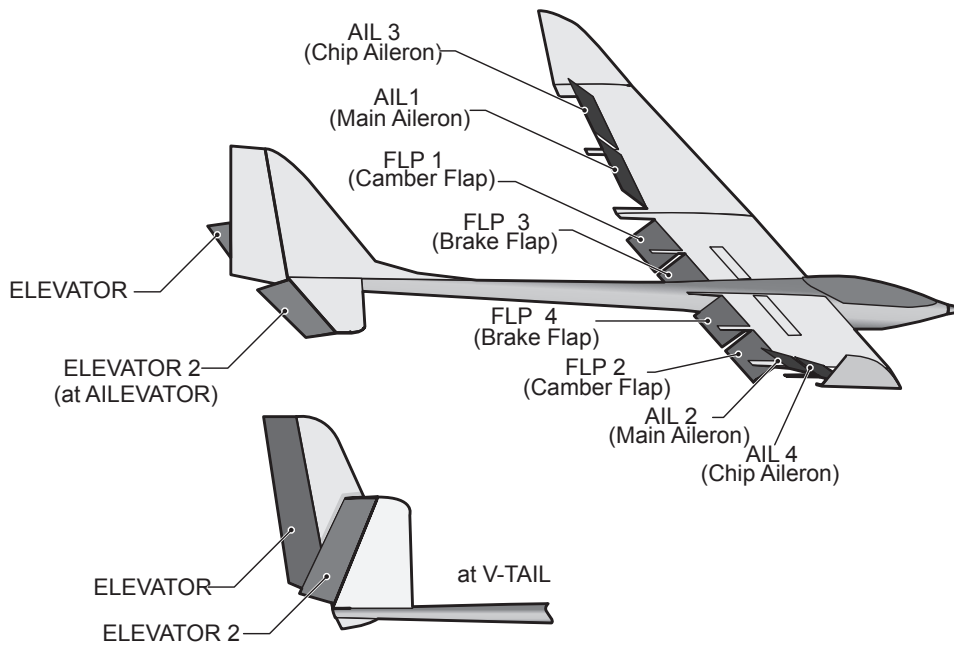



Trim Mix 1/2 [Corresponding model type]: Glider, 2 ailerons or more

The amount of ailerons, elevator, and flaps (camber flap, brake flap) trim offset can be set to a switch.

As an example **Trim Mix 1** can be set up for launching, with speed flaps and ailerons dropped, and a slight amount of up elevator. **Trim Mix 2** can be used for high speed flying, with both ailerons and speed flaps reflexed slightly, and a bit of down elevator.

The trim functions can be activated during flight by setting a switch. To prevent sudden trim changes when switching flight conditions, a delay can be set to provide a smooth transition between the two.

Example

1. Touch the ACT button and set the trim mix function to [ON].
*When separating the settings for each condition, touch the group mode button and set it to [Sngl].
2. Select the ON/OFF switch.
3. Select the [Manual] or [Auto] mode.
In the [Auto] mode, also select an auto SW. This switch can be linked to a stick, etc.

<Speed>
In: The operation speed at switch ON can be set.
Out: The return speed at switch OFF can be set.

<Fine Tuning>
The offset rate can be varied in the Fine Tuning numeric range set at screen [2/2] by VR, etc. selection.

<Condition Delay>
When flight conditions are set, the operation speed can be set for each condition. Condition delay operation can be interrupted and each rudder quickly returned to its original position by selecting a cut switch.

- Touch the [Trim Mix 1] button in the Model Menu to call the setup screen shown below.
(The display screen is an example. The actual screen depends on the model type. The screen shown below is for 4 ailerons and 4 flaps.)
(Touch the [1/2] button to switch to page 2.)
- Touch the ACT button and set the function to ACT (ON).
- When setting a switch, touch the Switch button to call the <Switch> screen, and then select the switch and set its ON direction. (Always ON at "ON" setting)

(Trim Mix setup page 1/2)

The screenshot shows the following interface elements:

- Top Bar:** Trim Mix 1, Model-1, Condition 1, 100%, 1/2
- Left Column:** ACT/INH (INH button), Group (Gr button), Switch (ON button), Mode (Manual button)
- Speed Section:** AIL, FLP, ELE with In and Out columns (all set to 0)
- Fine Tuning Section:** Control (NULL button)
- Cond. Delay Section:** Delay (0), Cut Switch (OFF)

Callouts and their descriptions:

- Group/single mode switching (Gr./Sngl) - points to the Gr button
- Return to Model Menu - points to the Model-1 label
- When using a fine tuning VR, touch this button to call the <Switch> screen. - points to the NULL button
- Ailerons, flaps, an elevators servo speed setting - points to the Speed section
- Condition delay setting and cut switch setting - points to the Cond. Delay section
- Manual/Auto mode selection
Manual: Switches the function ON/OFF by switch
Auto: Trim Mix function call can be linked to a stick, etc.
A stick switch, etc. separate from the function ON/OFF switch is set. - points to the Mode section

GLIDER

- The ailerons, flaps, and elevators offset rate can be adjusted.

Touch the corresponding button and adjust the rate with the adjustment buttons displayed on the screen.

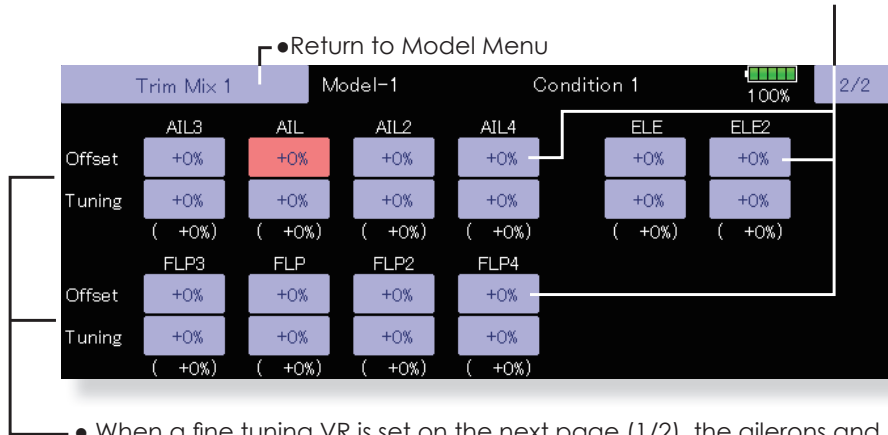

- When a fine tuning VR is set on the next page (1/2), the ailerons and flaps trim rates can be adjusted.

Touch the corresponding button and adjust the rate with the adjustment buttons displayed on the screen.

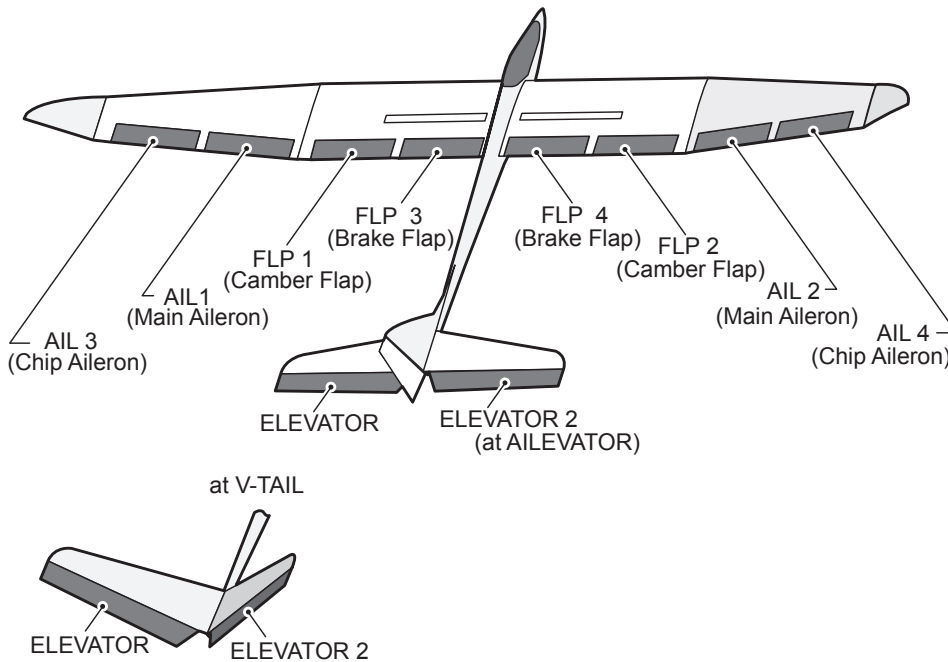



Airbrake

[Corresponding model type]: Airplane, general

AIRPLANE

This function is used when an air brake is necessary when landing or diving, etc.

The preset elevators and flaps (camber flap, brake flap) offset amount can be activated by a switch.

The offset amount of the aileron, elevator, and flap servos can be adjusted as needed. Also the speed of the aileron, elevator, and flap servos can be adjusted. (IN side/OUT side) A delay can be set for each condition, and a Cut switch which will turn OFF the delay can be chosen. Trim amounts can be fine-tuned by setting a VR You can also set the Auto Mode, which will link Airbrake to a stick, switch, or dial. A separate stick switch or dial can also be set as the ON/OFF switch.

Setting example for F3A and other flaperon specifications

(When 2 ailerons model type selected)
(Page 2/2)
Offset rate:
AIL: [-35~-45%], AIL2: [-35~-45%], ELE: [+5~7%]

Note: The input numerics are examples. Adjust the travel to match the fuselage.

(Page 1/2)
ACT: [ON]
Group: [Sngl]
Switch: [SC-C]
Mode: [Manual]

- Touch the [Airbrake] button in the Model Menu to call the setup screen shown below. (The display screen is an example. The actual screen depends on the model type. The screen shown below is for 4 ailerons and 4 flaps.)
- Touch the ACT button and set the function to ACT (ON).
- When setting a switch, touch the Switch button to call the <Switch> screen, and then select the switch and set its ON direction. (Always ON at "ON" setting)

• Group/single mode switching (Gr./Sngl)

• When using a fine tuning VR, touch this button to call the <Switch> screen.

• Return to Model Menu (Airbrake setup screen 1/2)

• Ailerons, flaps, an elevators servo speed setting
(For a description of the setting method, see the description at the back of this manual.)

• Condition delay setting (for a description of the setting method, see the description at the back of this manual) and cut switch setting.

• Manual/Auto mode selection
Manual: Switches the function ON/OFF by switch
Auto: Trim mix function call can be linked to a stick, etc. A stick switch, etc. separate from the function ON/OFF switch is set.

- The aileron, flap, and elevator offset rates can be adjusted.
Touch the corresponding button and adjust the rate with the adjustment buttons displayed on the screen.

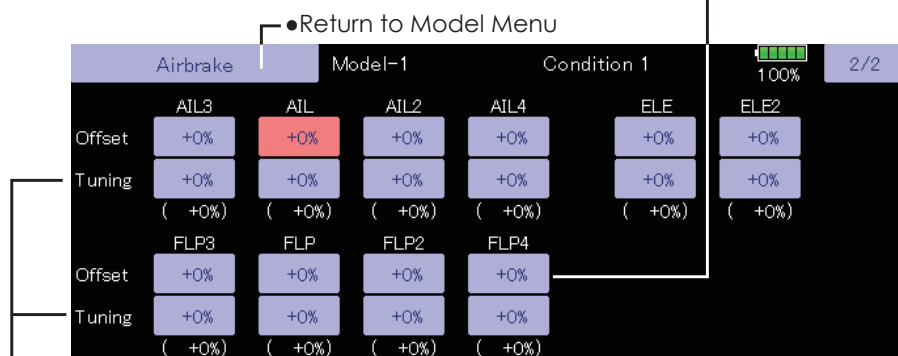

- When a fine tuning VR is set on the next screen (1/2), the aileron and flap trim rates can be adjusted. Touch the corresponding button and adjust the rates with the adjustment buttons displayed on the screen.

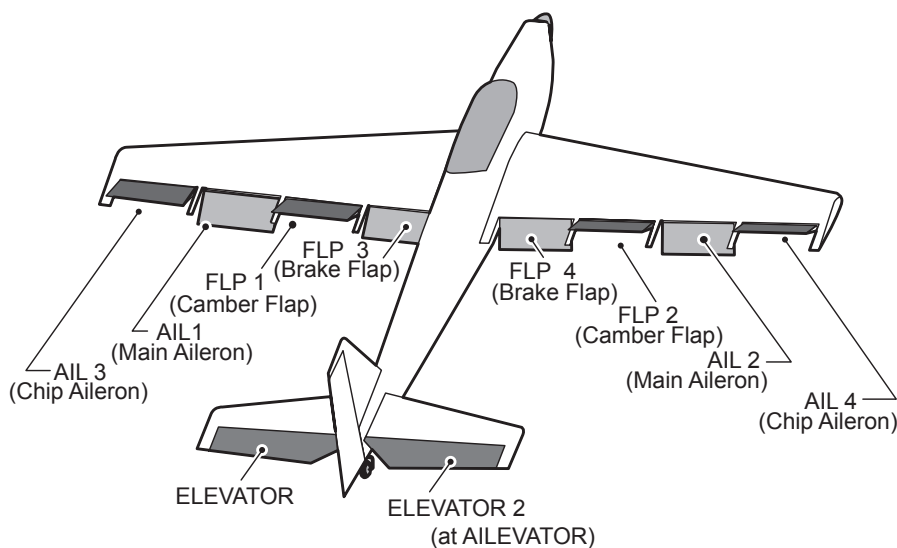



This function is used when a gyro is used to stabilize the fuselage attitude. The sensitivity and operation mode (Normal mode/GYmode) can be switched with a switch.

*Initial setting does not assign a sensitivity channel. Use the Function menu of the Linkage Menu to assign the sensitivity channel (Gyro/Gyro2/Gyro3) used to a vacant channel beforehand.

Set [ACT] and [Trim] other than Function to [NULL].

- Three rates (Rate1/Rate2/Rate3) can be switched.
- Up to three axes (Gyro/Gyro2/Gyro3) can be simultaneously controlled.

- Touch the [Gyro] button in the Model Menu to call the setup screen shown below.

- Group/single mode switching (Gr./Sngl)
(For more information, see the description at the back of this manual.)

•Return to Model Menu

• The operation mode (AVCS/NOR) and sensitivity of the 3 axes Gyro/Gyro2/Gyro3 can be set.

- Three rates (Rate1/Rate2/Rate3) can be used.
- Touch the ACT button of the rate to be used, and set the function to ACT ([ON] or [OFF]).
- When a Futaba gyro is used, when [GY] type is selected, the sensitivity set value is directly read in both the AVCS and NOR modes.
- When setting a switch, touch the switch button to call the <Switch> screen, and then select the switch and set its ON direction.

(Example) Setting three axis using a GYA450 and GYA451 (2)

- Wing type: Aileron 2 servos mounted fuselage selected
- Set **5CH → GYRO** (GYA451 AIL), **7CH → GYRO2** (GYA451 ELE), **8CH → GYRO3** (GYA450 RUD), **Control and Trim → NULL** : at the Function menu of the Linkage menu.
- GYRO setting of the Model menu.

Rate	ACT	Type	Switch	GYRO	GYRO2	GYRO3
1	OFF/ON	GY	SE	AVCS : 60%	AVCS : 60%	AVCS : 60%
2	INH					
3	ON/OFF	GY	SE	NORM : 60%	NORM : 60%	NORM : 60%

*Set so that Rate1 is turned on at the back position of switch E and Rate3 is turned ON at the front position. Since switch E is turned OFF at the center, Rate2 remains [INH].

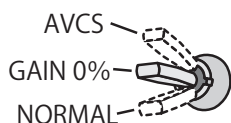

When AVCS is used we recommend that the sensitivity CH be set to the 3-position.

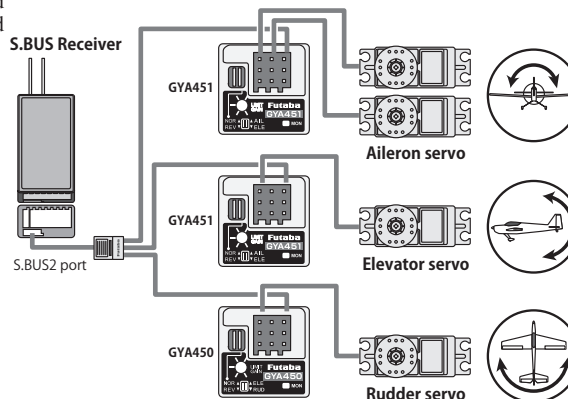

AIRPLANE

GLIDER

V-tail

[Corresponding model type]: Airplane/glider, V-tail



This function let's you adjust for left and right rudder angle changes at elevator and rudder operation of a V-tail airplane.

V-tail is when two servos are used together to control rudder movement as Elevators. In addition to each rudder side moving up and down together, each side moves in opposite directions when moving as Elevators. On a V-tail, this is also known as a Ruddervator, as they can serve the same purpose.

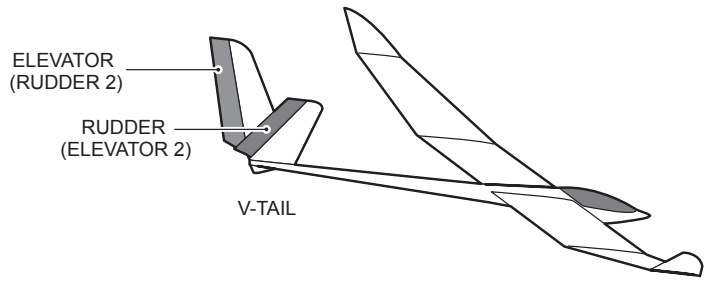

AIRPLANE

- Touch the [V-tail] button in the Model Menu to call the setup screen shown below.

•Return to Model Menu

• Group/single mode switching (Gr./Sngl)

	Model-1	Elevator Function		Rudder Function		Group
		Down	Up	Left	Right	
Elevator (RUD2)		+50%	+50%	+50%	+50%	Gr
Rudder (ELE2)		+50%	+50%	+50%	+50%	Gr

(Rudder function)
Left and right travel adjustment at rudder operation

(Elevator function)
Up and down travel adjustment at elevator operation

GLIDER

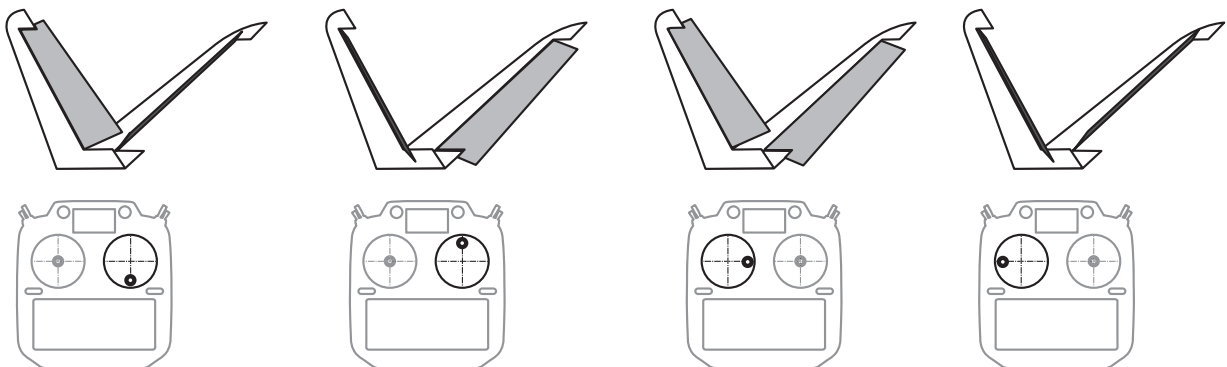

Ailevator

[Corresponding model type]: Airplane/glider

(Effective only when 2 servos used at the elevators)

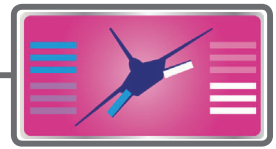

This function improves the operating performance of the roll axis by operating the elevators as ailerons.

Ailevator is where each elevator, like ailerons on a wing. In addition to each elevator side moving up and down together, each side moves in opposite directions when moving as an Ailevator. Typically, both Ailevator and ailerons are coupled together to maximize roll performance, especially on larger wingspan planes.

Note: Select Ailevator as the Model Type at the Model Type screen. This changes the output channel. Check the Function menu.

AIRPLANE

- Touch the [ALL] button in the Model Menu to call the setup screen shown below.

- Group/single mode switching (Gr./Sngl)

•Return to Model Menu

Ailevator		Model-1	Condition 1		100%
		Elevator Function	Aileron Function		Group
			Left	Right	Gr
Elevator (Aileron5)	Down	+100%	+0%	+0%	Gr
	Up	+100%			
Elevator2 (Aileron6)	Down	+100%	+0%	+0%	
	Up	+100%			

(Aileron function)

- When the elevators are used as ailerons, aileron travel of the left and right elevators can be adjusted.

(Elevator function)

- The up and down rate of the left and right elevators when the elevator stick is manipulated can be individually adjusted.

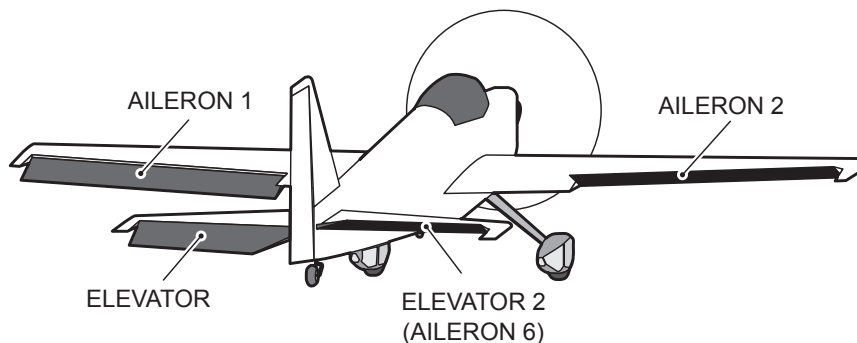

GLIDER

Winglet

[Corresponding model type]: Airplane/glider, winglet



This function adjusts the rudder left and right rudder angle of winglet specifications fuselages.

It can be used for special airplanes with two rudders. The amount of movement of the two mounted rudder servos can be adjusted separately. Two servos are operated with one rudder stick.

AIRPLANE

- Touch the [Winglet] button in the Model Menu to call the setup screen shown below.

GLIDER

•Return to Model Menu

• Group/single mode switching (Gr./Sngl)

(Rudder 1/2)

- The travel at rudder stick left and right operation can be individually set.

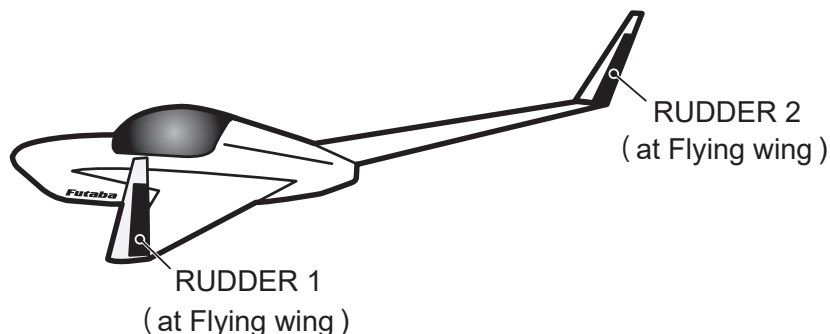

Motor

[Corresponding model type]: EP glider/Airplane, general



This function lets you set the operation speed when the motor of a F5B or other EP glider is started by switch. The operation speed can be set in 2 ranges of slow speed flight and high speed flight (Speed1/Speed2). This function can also be operated as a safety function by setting two switches.

- The In side and Out side operating speeds can be adjusted independently in two ranges (Speed1/Speed2).
- The boundary between the two ranges can be set. (From Speed1 to Speed2)
- The set operation speed operation can be activated at initial operation only. (one time operation) However, operation can be repeated by setting the switch to OFF before operation is finished. When you want to reset one

time operation, set the ACT button to [INH] and then reset it to [ON].

- The motor is controlled by SW-G [Mode1] SW-E [Mode2]. (Initial setting) When changing the switch or stick which controls the motor, first change Function of the Linkage Menu.

Note: When using this function, always check initial operation with the propeller removed.

Note: A warning message appears when this mix is on at the time of power up.

- Touch the [Motor] button in the Model Menu to call the setup screen shown below.

- Move the cursor by set switch or VR.

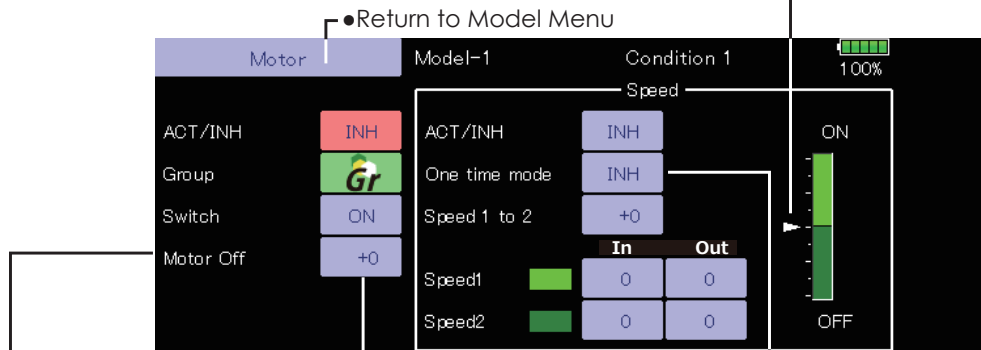

- Operation
Touch the button and set the function to ON.
- Group/single mode switching (Gr./Sngl)
- Switch
A switch that turns the function itself ON/OFF can be selected.
- Motor off
[Yes] and [No] are displayed by touching the Motor Off button when [SW-G (Mode1)] [SW-E (Mode2)] (Initial setting) is in the motor OFF position. When [Yes] is touched, the direction of the motor switch is memorized. The screen graph display ON direction also changes.

- Operation
Touch the button and set the function to ON.
- When you want to set the "One time mode", touch the button and set the mode to [ON].
- Speed1 to 2
The Speed1 and Speed2 region boundary can be changed,
- Operation speed adjustment
The speed when Speed1 and Speed2 are ON (In) and OFF (Out) can be adjusted.

Notes

- First decide the motor OFF point, and then set the speed. When you want to reset the motor OFF point, also reset the speed.
- We recommend that Motor OFF be set in combination with F/S.
- Set the basic operation direction with the Reverse function to match the amp used.
- Always set the Motor OFF position.

AIRPLANE

GLIDER

RUD to ELE

[Corresponding model type]: Airplane, general



AIRPLANE

This function is used when you want to mix elevator operation with rudder operation. It is used to correct undesirable tendencies when rudder is applied in roll maneuvers, knife edge, etc. of acrobatic planes.

- A mixing curve can be set.
- Mixing during flight can be turned ON/OFF by setting a switch. (Always ON at "ON" setting)
- The amount of correction rudder can be memorized by using the Memory function. This is convenient at mixing curve setting. When memory

operation (switch operation) is performed with correction rudder applied in the Memory Mode, the stick position at that time is displayed on the mixing curve. The point is automatically reflected in the curve. (When the Memory function is used, "Line" is automatically selected as the curve type.)

- Link can be set: Links this mixing to other mixings.
- The mixing rate can be fine-tuned by setting a VR. (Fine tuning)

- Touch the [RUD to ELE] button in the Model Menu to call the setup screen shown below.

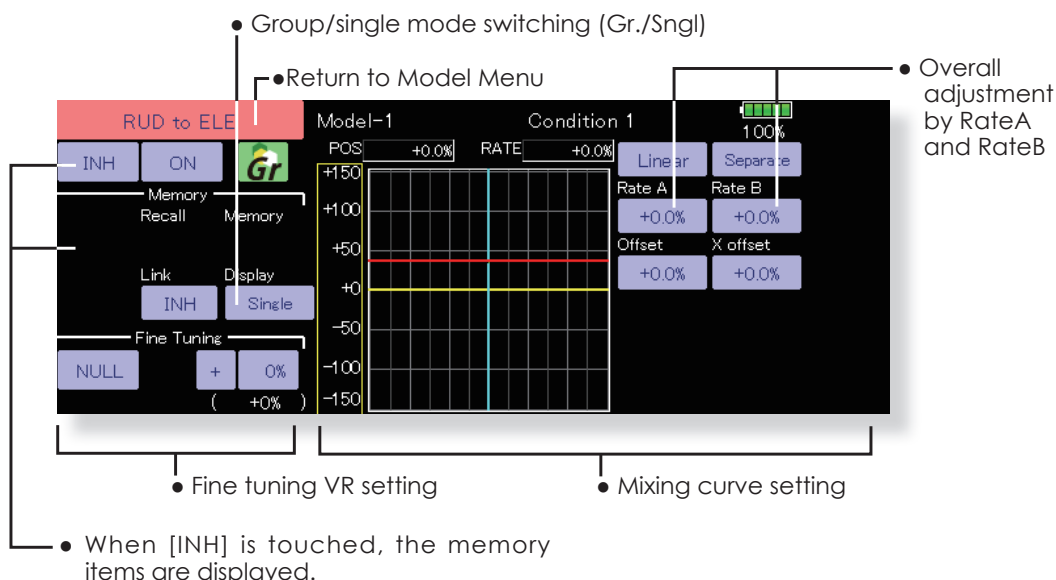

Setting method

- Touch the "INH" button, and set the function to ACT (ON).
- When setting a switch, touch the "ON" button to call the <Switch> screen, and then select the switch and set its ON direction. (Always ON at "ON" setting)
(For a description of the switch setting method, see the description at the back of this manual.)
- When setting a VR, touch the Fine Tuning "NULL" button to call the <Switch> screen, and then select the VR. The fine tuning rate and adjustment direction can be set.
The VR operation mode can also be set.
- The curve display mode can be changed.
Single : Displays the mixing curve only
Fine Tuning : Displays the fine tuning rate of the fine tuning VR
All Cond. : Displays the mixing curve of all the conditions (When conditions are set)
- When setting Link, touch the Link button and set it to ON.

Memory function usage method

(Example) Using the memory function with an F3A airplane (knife edge correction)

*When call switch ⇒[SW-A] and memory switch ⇒[SW-H] were set

[Memory function operation]

1. Memory function mode: [Manual]⇒[Memory]
2. When the memory switch (SW-H) is set to ON while performing elevator correction when rudder was applied at knife edge, the point position at that time is memorized. Memorization is performed while changing the left and right stick positions.
3. To recall the memorized positions, set [SW-A] to ON. The memorized correction rate is reflected on the curve, and operation is simultaneously set.

Note: When memorized from manual before flight, be sure that the memory SW is not accidentally set to ON and incorrect mixing setting is not applied when taxiing, starting the engine, etc.

Snap Roll

[Corresponding model type]: Airplane, general



This function selects the switch and rate adjustment of each rudder, (ailerons, elevators, or flaps) when a snap roll is performed.

- Four snap roll directions can be set. (Right/up, right/down, left/up, left/down)
- Operation mode: When [Master] mode is selected, the Snap Roll function is turned ON/OFF by master switch in the state in which the direction switch was switched to the direction in which you want to snap roll. When [Single] mode is selected, snap roll in each direction can be executed by means of independent switches.
- A safety switch can be set. As a safety measure, the switch can be set so that snap roll is not executed when, for instance, the landing gear is lowered, even if the switch is turned on accidentally. The snap roll switch is activated only when the safety switch is ON.
- The operation speed of the aileron, elevator, and flap servos can be adjusted for each snap roll direction. (In side/Out side) (Page 2/2)

(Example) Setting example for F3A

- Mode: [Master]
- Safety SW: [SW-G] (Safety measure)
- Master SW: [SW-H] (Main switch for executing snap roll)
- Direction switches:
 - *The snap roll up side left and right and down side left and right direction switches are selected here.
 - Right/Up: OFF [SW-D] Right/Down: OFF [SW-D] Left/Up: OFF [SW-A] Left/Down: OFF [SW-A]
- Speed adjustment (Screen 2/2)

The operation speed of each control surface when the snap switch is ON can be changed and snap roll executed by stick while there is switch operation can be performed.

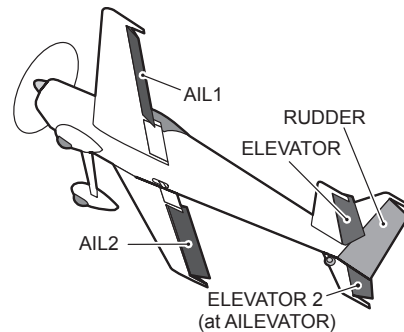

AIRPLANE

- Curve display mode switching (Single/Fine tuning/All Cond.)

- Group/single mode switching (Gr./Sngl) (For more information, see the description at the back of this manual.)

Return to Model Menu

Snap Roll		Model-1	Condition 1	100%	1/2	
Mode	Master	Safety SW	ON	Group	Gr	
Master SW	OFF					
		ACT	Switch	Rate		
				AIL	ELE	RUD
Right / Up		OFF	OFF	+100%	+100%	+100%
Right / Down		OFF	OFF	+100%	-100%	-100%
Left / Up		OFF	OFF	-100%	+100%	-100%
Left / Down		OFF	OFF	-100%	-100%	+100%

- Direction switches

- Rate adjustment of each rudder

Speed

	AIL		ELE		RUD	
	In	Out	In	Out	In	Out
Right / Up	0	0	0	0	0	0
Right / Down	0	0	0	0	0	0
Left / Up	0	0	0	0	0	0
Left / Down	0	0	0	0	0	0

- Adjustment of the servo speed of each rudder



Multi Engine [Corresponding model type]: Airplane, general

AIRPLANE

This function lets you adjust the throttle when using a multi engine airplane with up to four engines. The Throttle Cut function, Idle Down function, Throttle Hold function, High Trim, and Idle Trim can be adjusted by throttle channel (THR, THR2, THR3, THR4).

*Initial setting assigns only one throttle channel (THR). When using this function, the number of throttle channels must be assigned beforehand at the Function menu of the Linkage Menu.

- The throttle cut position can be set for each throttle channel. Throttle cut operation is linked to the switch set with the Throttle Cut function of the Linkage Menu.
- *The throttle cut position set at this screen is effective.
- The throttle down offset rate can be set for each throttle channel. Idle down operation is linked to

the switch set with the Idle Down function of the Linkage Menu.

- *The idle down offset rate set at this screen is effective.
- Operation can be fixed at the engine speed (carburetor opening angle) for each throttle channel with the Hold Position function. The hold position can be changed.
- High side trim and idle trim can be set for each channel. Operation acts as high trim or idle trim based on the center.

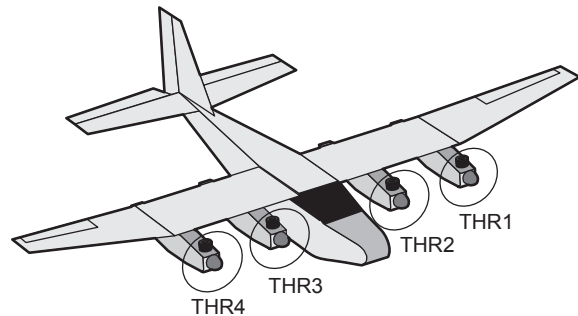

*The number of engines (1~4) assigned by Function menu in the Linkage Menu setup screen is displayed.

- Touch the [Multi Engine] button in the Model Menu to call the setup screen shown below.

• Return to Model Menu

Multi Engine		Model-1				Condition 1		100%	1/2
		THR	THR2	THR3	THR4			Group	
ACT/INH		INH	INH	INH	INH			Gr	
Throttle Cut	ACT	INH	INH	INH	INH				
	Posi.	17%	17%	17%	17%				
Idle Down	ACT	INH	INH	INH	INH				
	Rate	17%	17%	17%	17%			Hold Pos.	
Throttle Hold		INH	INH	INH	INH			17%	

- Throttle cut position setting (for each engine)
- Idle down offset rate setting (for each engine)
- Throttle hold position setting

Multi Engine		Model-1				Condition 1		100%	2/2
		THR	THR2	THR3	THR4				
High Trim	Control	NULL	NULL	NULL	NULL				
	Rate	+	0%	+	0%	+	0%	+	0%
			(+0%)	(+0%)	(+0%)	(+0%)			
Idle Trim	Control	NULL	NULL	NULL	NULL				
	Rate	+	0%	+	0%	+	0%	+	0%
			(+0%)	(+0%)	(+0%)	(+0%)			

- High Trim setting (for each engine)
- Idle Trim setting (for each engine)

Acceleration

[Corresponding model type]: EP glider, glider

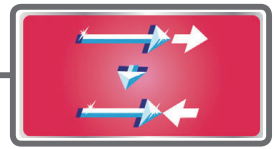

Acceleration setting can be performed at elevator, ELE to Camber and AIL to RUD. (Glider and EP glider only)

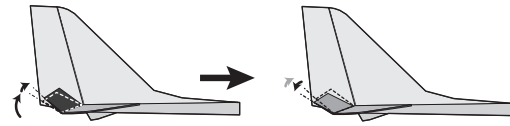

- This setting is divided into elevator setting and camber setting. The setting method is the same.
- Camber setting sets the acceleration function for ELE to Camber mixing. Setting is not performed when ELE to Camber mixing is INH.
- The acceleration function can be set for both the Up side and Down side.
- Function ON/OFF switch setting is performed for AIL to RUD setting only.
- AIL to RUD setting is acceleration function setting for AIL to RUD mixing. It is not performed when AIL to RUD mixing is INH.

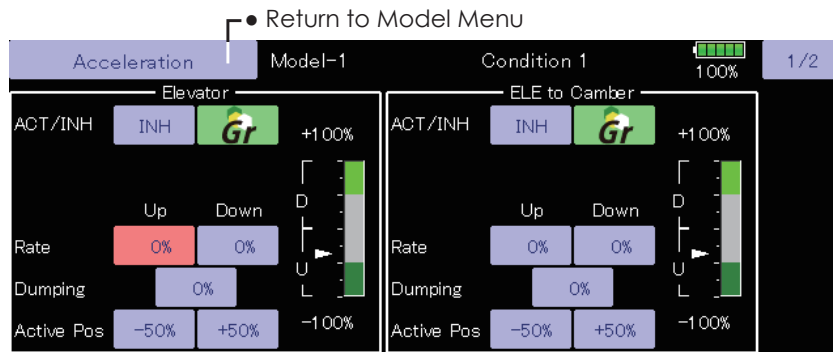

• Elevator Acceleration

• ELE to Camber Acceleration

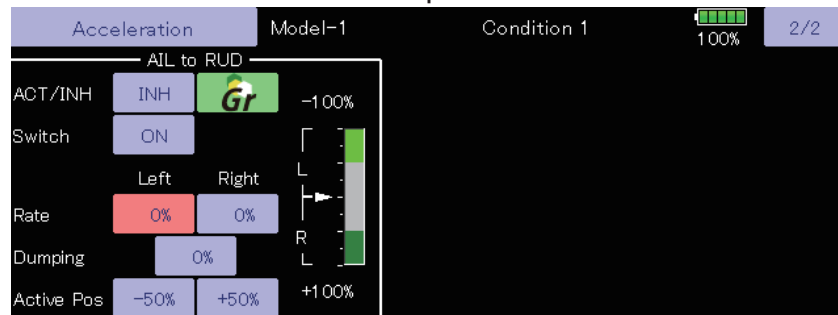

• AIL to RUD Acceleration

GLIDER

MODEL MENU (HELICOPTER)

This section contains information on the commands that apply to helicopters only. For instructions on Airplanes and Gliders, refer to the sections pertaining to those aircraft. Each of these functions can be set independently for different flight conditions. To get to these settings, touch the desired function button to be accessed.

Use the Model Type function in the Linkage Menu to select the swash type matched to the fuselage beforehand. If you later change model types, all settings will be lost.

Also, add flight conditions at the Condition Select screen

before setting the model data at each function. (Up to eight conditions can be used)

The AFR function, fuel mixture and other functions common to all model types, are described in a separate section.

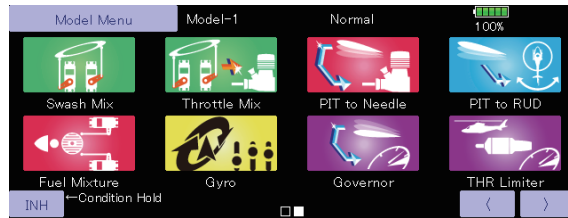
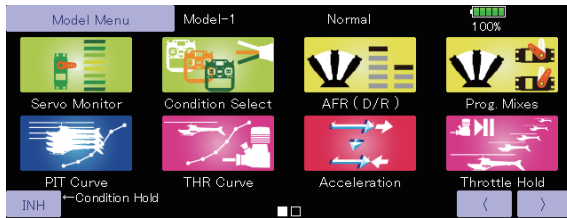

Condition Hold function ON/OFF button

1. Set the throttle stick lower than the 1/3 point.
2. Push the INH button to activate the condition hold function.

This function may be used to limit the maximum speed of the engine so that you may adjust flight conditions when the engine is running. An alarm indicates that the function is operating. It will prevent the engine from racing dangerously when adjusting the Idle-Up settings.

While this function is active, the throttle servo position is fixed at the point that you have indicated when the function is activated. You must deactivate this function when you are through making adjustments.

The system will not allow you to activate/deactivate this function in either of the following states:

- When any of the flight condition switches are on.
- When the throttle stick is higher than the 1/3 point.

Model Menu functions (helicopter) table

PIT Curve: Adjusts response in different flight conditions

THR Curve: Throttle curve and hovering trim adjustment

Acceleration: Counteracts torque due to sudden throttle and pitch commands

Throttle Hold: Moves the throttle to idle during autorotation

Swash Mix: Compensates for each control response

Throttle Mix: Compensates for power loss when cyclic applied

Pit to Needle: Adjusts response curve in different flight conditions

Pit to RUD: Handles torque changes from pitch angle inputs

Fuel Mixture: Commands a second servo to adjust the fuel mixture at the carburetor

Gyro: Used to switch Futaba GY series gyro sensitivity

Governor: Used to switch RPM of the helicopter's head

Throttle Limiter: Limits the high range of the throttle movement by any slider or trimmer

PIT Curve/Pitch Trim



PIT Curve

This function adjusts the pitch operation curve for each flight condition for the optimal flight response relative to movement of the throttle stick.

The pitch curve can be freely selected from linear operation curve to smooth curve, and adjusted to match the curve you want by means of the T32MZ's powerful Curve Edit Function (Six types of curves can be selected). Up to 17 points can be set for linear or curve types. However, when using the 3 points or 5 points specified to create a

curve, a simple and smooth curve can be created by selecting the curve type and reducing the number of input points to 3 or 5, and then entering the specified value at the corresponding points that you created. A curve, a simple and smooth curve can be created by selecting the curve type and reducing the number of input points to 3 or 5, and then entering the specified value at the corresponding points that you created.

- Touch the [PIT Curve] button in the Model Menu to call the setup screen shown below.
- There are four types of display. The curve of all the conditions or the pitch and throttle curves can be displayed on one screen.
- Linear type is 9 points, but for simple use, 4~5 points are sufficient.
- Normally use Separate.
- Return to Model Menu

- Trim can be used as hovering pitch and pitch trim. The high and low side pitch can be fine-tuned.
- Units can be selected from [%] and [Deg]. When [Deg] is selected, the rotor pitch angle is displayed and becomes the setting standard. When [Deg] was selected, the high, center, and low pitch angles are entered.
- Can be copied to the pitch trim adjustment position.
- When the [Angle] button is touched, the pitch angle input screen is displayed. Input the maximum pitch, center, and low pitch.

Normal curve adjustment

- For normal curve, usually use [Line] type and create a basic pitch curve centered about hovering. Use this function together with the THR Curve (Normal) function and adjust the curve so that up/down control is best at a constant engine speed.

Idle up curve adjustment

- For the high side pitch curve, set the maximum pitch which does not apply a load to the engine. For the low side pitch curve, create curves matched to loop, roll, 3D, and other purposes and use the idle up curves according to the performance.

Note: If you change the curve type, all data will be reset.

Throttle hold curve adjustment

- The throttle hold curve is used when executing auto rotation dives.

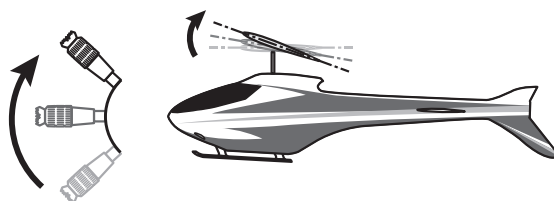

Operation precautions

⚠ WARNING

- When actually starting the engine and flying, always set the idle up condition switch to [OFF] and start the engine in the idling state.

HELICOPTER

Setting method

- Group button: When you also want to enter the data to all other conditions, enter the data in the group mode (GRP). When doing so, the same settings are input to all the other conditions. When you want to set data into each condition independently, select the single (SNGL) mode.
- Normal % input or angle input can be selected at rate adjustment at curve setting. For angle input, if the high side, low side, and center angles are input beforehand, the rate can be set by reading the angle directly (standard).
- The curve graph display mode can be selected. This is convenient when checking curves other than the curve currently being set.
[Sngl]: Displays only the curve currently being set
[Fine Tuning]: When pitch trim is used, a curve with pitch trim adjustment added is also displayed.

[All Cond.]: Displays the pitch curve of all the conditions. The curve of the condition currently in use is indicated by a bold line.

[PIT&THR]: The throttle hold curve of the condition currently in use is also displayed.

- The Throttle Curve setup screen can be selected with one touch, which is convenient when making adjustments alternately with the throttle curve.
- The servo operation speed can be set. When adjusted when the pitch is too sensitive, the pitch operation feeling can be changed.
- When increasing the number of points on your curve, use the cursor keys [←][→] and move the cursor to the spot where you want to enter a new curve point (■), then touch the Rate button. A new point is created.

Curve setting examples

The screens shown below are curves created by entering the pitch angle at low, center, and high side 3 points or 5 points at each condition. They were created by reducing the number of points to the 3 points of low side, center, and high side. When actually creating a curve, input the angle specified at the fuselage (or the reference value).

*For a description of the curve setting method, see the description at the back of this manual.

•Pitch Curve (Example)

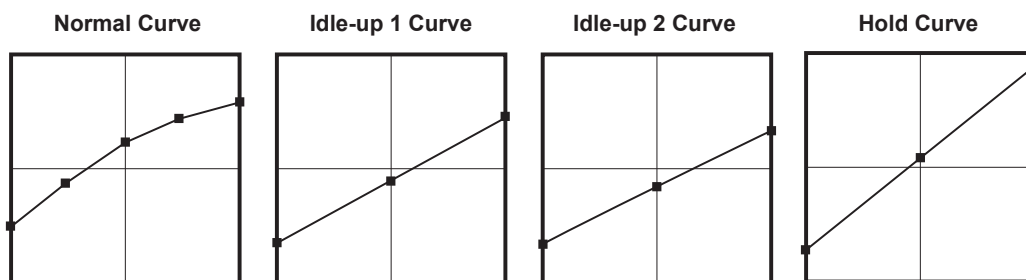

Pitch Trim (Hovering pitch, high pitch, low pitch)

The hovering pitch, low pitch, and high pitch trim setup screen can be selected from the PIT Curve setup screen.

HELICOPTER

The screenshot shows the Pitch Trim setup screen for Model-1. The screen is divided into two main sections: Hover and Low Pitch / High Pitch.

Hover Section:

- ACT/INH: INH (Inactive)
- Mode: CTRM
- Rate: 30% (+0%)
- Range: 100%
- Control: NULL

Low Pitch / High Pitch Section:

- ACT/INH: INH (Inactive)
- Rate: 0% (+0%) for both Low Pitch and High Pitch
- Control: NULL for both Low Pitch and High Pitch

Annotations:

- Return to Model Menu (pointing to the top bar)
- Adjusts the adjusting dial. (pointing to the Rate field)
- Hovering pitch trim setting (pointing to the Hover section)
- Low/High pitch trim (pointing to the Low Pitch / High Pitch section)

Hovering pitch trim

The Hovering Pitch function trims the pitch near the hovering point. Normally, it is used with the hovering condition. The hovering pitch can be fine tuned for changes in rotor speed accompanying changes in temperature, humidity, and other flight conditions. Adjust the hovering pitch so that rotor speed is constant. This function can be used together with the Hovering Throttle Trim function for more delicate operation.

Setting method

- When using only the hovering (normal) condition, switch the group button to the single mode before setting.
- Set the function to ACT [ON].
- Select the adjustment knob. Selection example: LD or T6
- The trim operation mode (Mode: CTRM/NORM) can be selected.
CTRM mode: Maximum change near center by center trim operation (Does not change at end of the stick movement)
NORM mode: Normal trim (linear) operation. The advantage of using this mode is that the hovering pitch can be adjusted without changing the curve.
- Trim adjustment range (Range) setting
When this value is made small, trim can only be used near the center.
- The trim rate can be adjusted and the operation direction can be changed.

High Pitch/Low Pitch Trim

High Pitch/Low Pitch Trim is the pitch servo high side and low side trim function.

Setting method

- When setting the adjustment knobs common to all the conditions, set them in the group mode.
- Set the function to ACT (ON).
- Select the adjustment knobs. Selection example: LST (high side), RST (low side)
- The trim rate can be adjusted and the operation direction can be changed.
- Trim acts as high side or low side trim with the center as the standard.

THR Curve/Throttle Hover trim

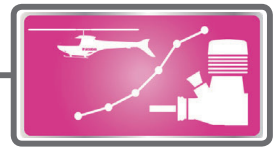

THR Curve

This function adjusts the throttle operation curve for each condition for optimizing the engine speed to throttle stick movement.

A throttle curve from linear operation to smooth curve can be set. Adjustment to the curve you want to use is possible by using the 32MZ's powerful Curve Edit Function. Up to 17 curve points can be set, however, when the 5 points and other point data is used, a smooth curve can be easily created by reducing the number of points of to 5 and entering the specified value at the corresponding points.

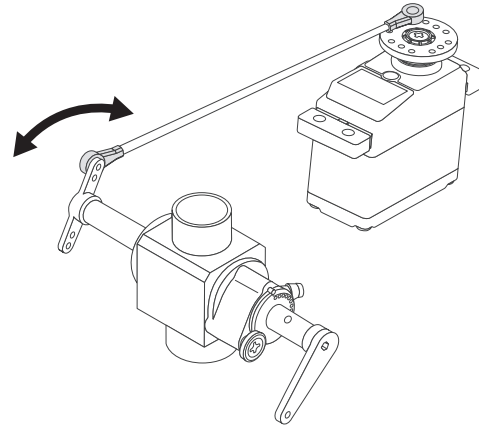

- Touch the [THR Curve] button in the Model Menu to call the setup screen shown below.

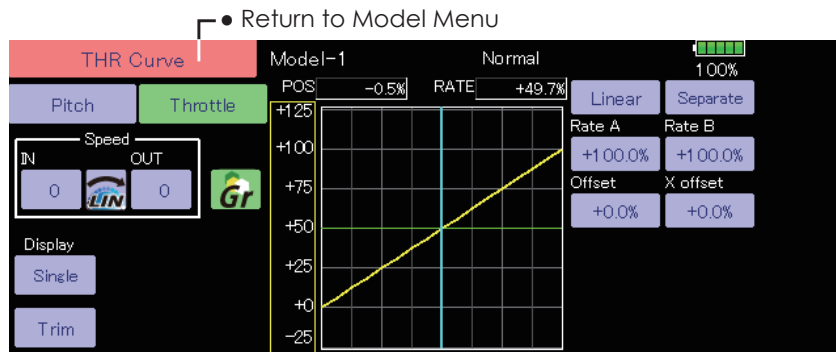

Normal curve adjustment

- Normal curve creates a basic curve centered around hovering. Use it along with the normal pitch curve and adjust so that up/down control at a constant engine speed is easiest.

Idle up curve adjustment

- Set a normal up curve that maintains a constant speed at all times, even when operation which reduces the pitch was performed in flight. Create a curve matched to loop, roll, 3D, or other purposes and the idle up curve according to the performance.

Setting method

- Group button: When you also want to enter the data to all other conditions, enter the data in the group mode (GRP). When doing so, the same settings are input to all the other conditions. When you want to set date into each condition independently, select the single (SNGL) mode.
- The curve graph display mode can be selected. This is convenient when checking curves other than the one being set.
[Sngl]: Displays only the curve being set.
[Fine Tuning]: When Throttle Hover trim is used, a curve with trim adjustment added is also displayed.
[All Cond.]: Displays the throttle curve of all the

Operation precautions

⚠ WARNING

- ! When actually starting the engine and flying, always set the idle up condition switch to [OFF] and start the engine in the idling mode.

- conditions. The curve of the condition currently in use is indicated by a bold line.
[PIT&THR]: The pitch curve of the condition currently in use is also displayed.
- The pitch curve setup screen can be selected with one touch. This is convenient when alternately adjusting these curves with the pitch curve.
- The servo speed can be set. Adjust the throttle speed when the throttle is too sensitive

Curve setting examples

The curves shown below were created by using the Line mode and inputting the data of the 5 points 0% (low side), 25%, 50% (center), 75%, 100% (high side) at each condition. They were created by reducing the number points of the line to 5. When actually creating a curve,

enter the data specified per the fuselage (or the reference value).

•Throttle Curve (Example)

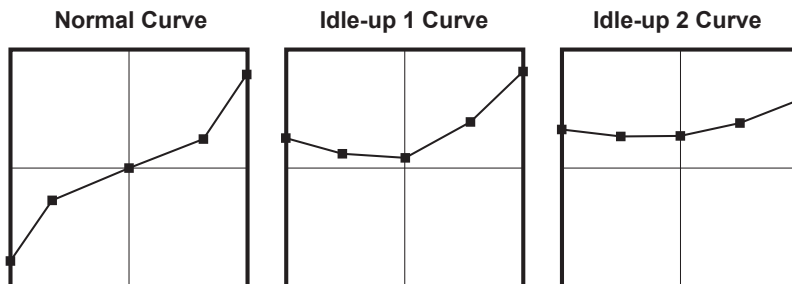

Throttle Hover trim

The Throttle Hover trim setup screen can be selected from the THR Curve setup screen.

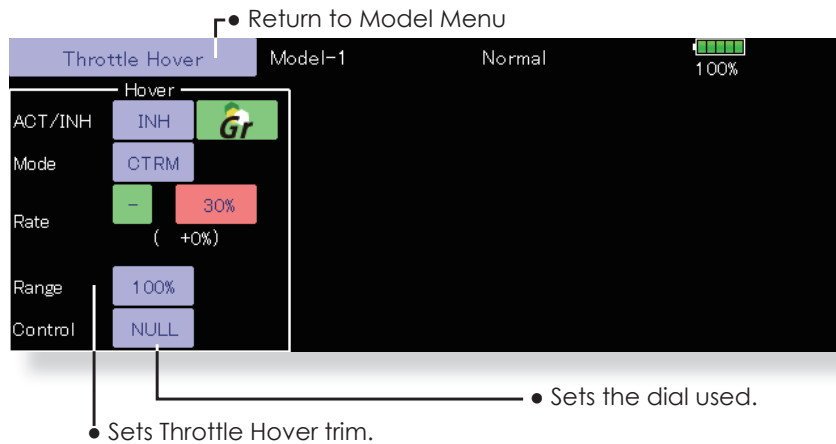

The Throttle Hover function trims the throttle near the hovering point. Normally, use it with hovering conditions. Changes in rotor speed accompanying changes in the temperature, humidity, and other flight conditions can be trimmed. Adjust the throttle so that rotor rotation is most stable. More delicate trimming is also possible by using this function along with the Hover Pitch function.

Setting method

- When using the hovering (normal) condition only, switch the [Gr.] (group button) mode to the [Sngl] (single) mode and make the settings.
- Set the function to ACT ([ON]).
- Select the adjustment knob. Selection example: RD
- The trim operation mode (Mode: CTRM/NORM) can be selected.
 - CTRM mode:** Maximum change near center by center trim operation (Does not change at end of the stick movement)
 - NORM mode:** Normal trim (linear) operation The advantage of using this mode is that hovering throttle can be adjusted without changing the curve.
- Trim adjustment range (Range) setting
When the value is made small, trim acts only near the center.
- The trim rate can be adjusted and the operation direction can be set.

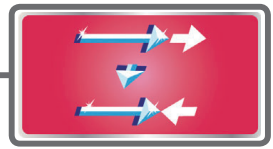

Acceleration Mixing

An acceleration function can be set. This is used to adjust the pitch and throttle settings when the mixture is either too rich or too lean, which can be caused by sudden operation of the throttle stick.

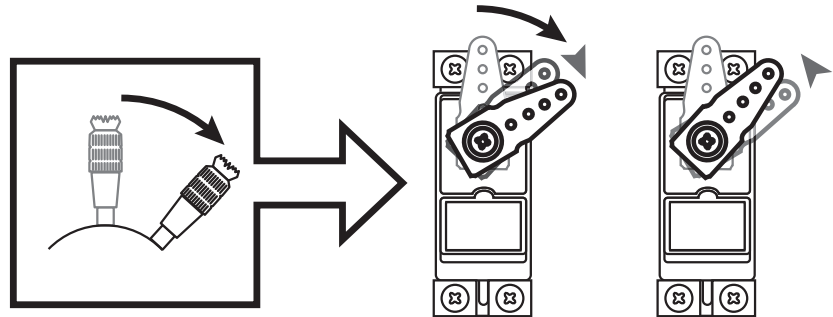

- Touch the [Acceleration] button in the Model Menu to call the setup screen shown below.

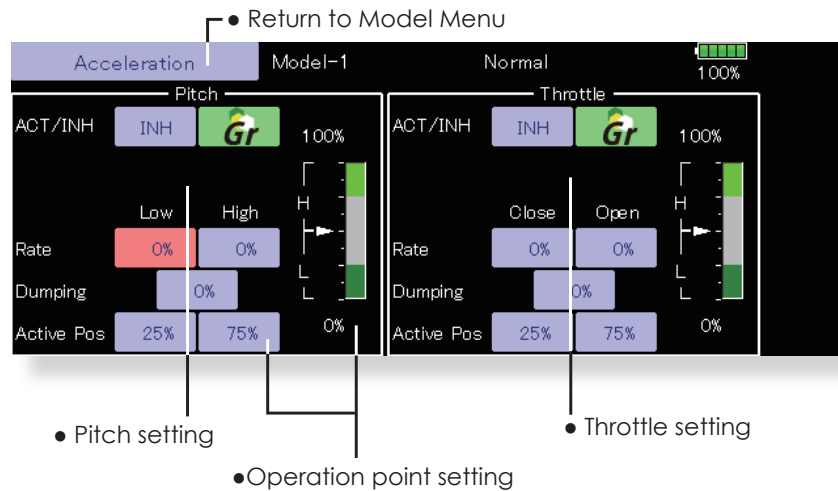

Setting method

- Acceleration can be set at both setting at acceleration (high) and setting at deceleration (low). (The operation point is displayed on a graph.)
- Acceleration rate setting (Rate)
- The return time after operation (Dumping) can be set.
- The operation point at acceleration and deceleration can be set. When an operation point is exceeded, acceleration is performed.

Note: When using the Acceleration function, since the pitch stroke is large, make your settings so there is no binding of your linkage.



Throttle Hold

This function sets the throttle cut position during an auto rotation dive. The throttle position can also be set to an idling position separate from the throttle cut position. Setting of these two positions can be selected by switch. This allows use for switching during training.

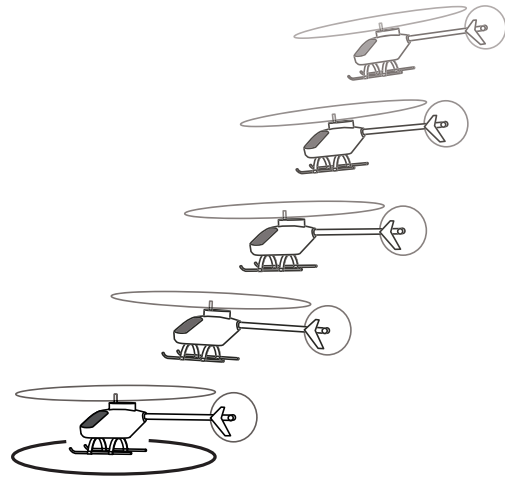

- Touch the [Throttle Hold] button in the Model Menu to call the setup screen shown below.

Example of use

- Since Throttle Hold has two modes (Cut) and (Idle), it is convenient to use it in the Idle mode during training and in the Cut mode when stopping the engine.

Note: When throttle hold is set to ON in the normal condition, throttle hold acts and the throttle servo is deactivated. Always set throttle hold to ON in the hold condition.

Operation precautions

⚠ WARNING

- ❗ When starting the engine, confirm that the idle up condition and throttle hold condition are [OFF].

Setting method

- Operation mode selection
 - Manual mode:** The throttle hold function is operated by switch operation only.
 - Auto mode:** The throttle hold function operation is linked to the throttle stick position.
 - Auto position setting:** When the Auto mode was selected, the throttle position (auto position) can be selected. Move the throttle stick to the position you want to set and touch the (auto position) button.
- Hold position adjustment
 - Throttle Hold (Cut)** sets the throttle cut position. Adjust it so that the carburetor is full open.
 - Throttle Hold (Idle):** Make this adjustment to maintain idling for training. Adjustments can be made based on the throttle curve idle position.
- The throttle servo operating speed can be adjusted. (Speed)
- The Hold switch can be used to change between the Throttle cut or Training function.



Swash Mixing

The swash mix function is used to correct the swash plate in the aileron (roll) direction and elevator (cyclic pitch) corresponding to each operation of each condition.

Adjustment by independent curve for aileron, elevator, and pitch operations is possible. The operation can be smoothly adjusted by calling up the “Curve setup” screen by touching the button that corresponds to the mixing and direction which needs correction.

Example of use

- As an example, use swash mixing to correct undesirable tendencies in the roll direction
- For a condition which uses AIL to ELE, set this function to ON. When raising the nose at a right roll, when the RateB side is input and the right aileron is operated, the elevator moves to the down side. Tune by adjusting the Rate. For right roll, adjust to the RateA side.

- Touch the [Swash Mix] button in the Model Menu to call the setup screen shown below.



Setting method

- When using this function, touch the [INH] button and display [ON] or [OFF].
- When you want to set the same settings to other conditions, select the group mode (Gr.). When you want to add settings to the selected condition only, select the single mode (Sngl).
- The correction rate can be set by curve.
- A switch can be set.
When [ON] is set, the swash mixing function is operated by merely selecting the condition.
When setting an [ON]/[OFF] switch, touch the [ON] button and set the switch and its ON position at the <Switch> screen.
- Trim on /off setting
You can select mixing characteristics either with trim or without trim.



Throttle Mixing

This function corrects slowing of the engine speed caused by swash plate operation during aileron or elevator operation. The method of applying clockwise or counterclockwise torque when pirouetting can also be corrected.

An acceleration function which temporarily increases the throttle side correction rate relative to rapid stick operation can also be set.

When correction is necessary, touch the mixing corresponding to the mixing that needs correction to call the curve setup screen, and then correct the slowing.

- CTRM mode: The mixing rate is reduced by the throttle stick high and low position.
- LINEAR mode: Constant mixing rate to all the throttle stick ranges.

- Touch the [Throttle Mix] button in the Model Menu to call the setup screen shown below.

Setting example

- AIL to THR applies a load to the engine and corrects sinking of the engine speed when the throttle stick was operated. Engine racing can be adjusted independently at the right aileron and left aileron by Rates A and B.

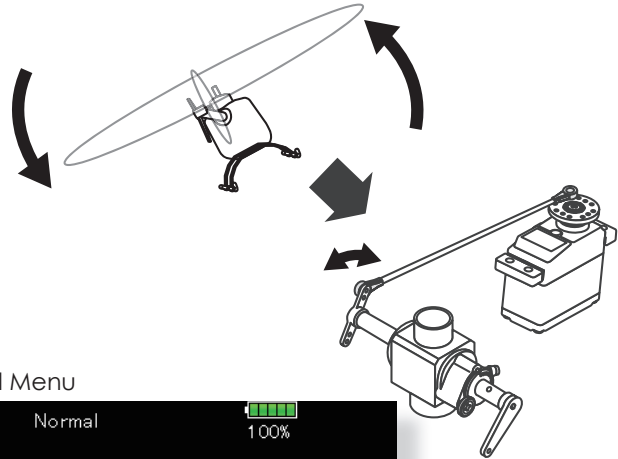

• Return to Model Menu

Mixing	ACT	Switch	Mode	Group
AIL to THR	INH	ON	CTRM	Gr
ELE to THR	INH	ON	CTRM	Gr
RUD to THR	INH	ON	CTRM	Gr

• Mode selection

AIL to THR		Model-1	Normal	100%	Return
ACT	INH	POS +0.0%	RATE +0.0%	Linear	Separate
Switch	ON			Rate A	Rate B
Acceleration				+0.0%	+0.0%
	Left			Offset	X offset
	Right			+0.0%	+0.0%
Rate	0%				
Dump.	0%				
Act.Pos.	-50%				
	+50%				

Setting method

- When using this function, touch the [INH] button and display [ON] or [OFF].
- When you want to set the same settings to other conditions, select the group mode (Gr.). When you want to add settings to the selected condition only, select the single mode (Sngl).
- The correction rate can be set by curve.
- A switch can be set.
When [ON] is set, the function is operated by merely selecting the condition.
When setting an [ON]/[OFF] switch, touch the [ON] button and then set the switch and its ON direction at the <Switch> screen.

<Acceleration function setting>

- Acceleration can be set for both settings (High) and (Low) at maximum correction rate.
- Acceleration rate setting (Rate)
- The return time (Dump.) after operation can be set.
- The operation point when the correction rate is increased and decreased can be set independently. When an operation point is exceeded, acceleration operation is performed.



PIT to Needle Mixing

This mixing is used when the engine is equipped with needle control or other fuel-air mixture adjustment. A needle curve can be set.

The acceleration function which can temporarily increase needle operation during throttle acceleration/deceleration operation can be set. The rise characteristic of the needle servo during acceleration and deceleration operation can be adjusted.

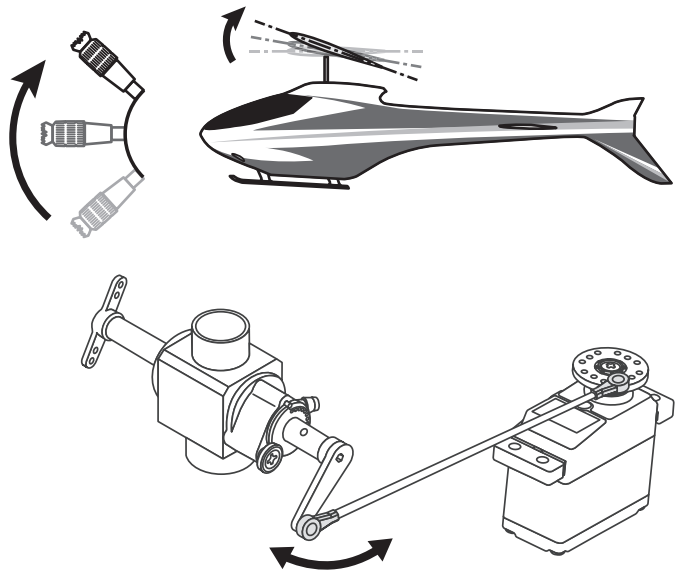

- Touch the [PIT to Needle] button in the Model Menu to call the setup screen shown below.

• Return to Model Menu

• Normally, use [Linear] type.

Setting method

- When using this function, touch the [INH] button and display [ON] or [OFF].
- When you want to set the same settings to other conditions, select the group mode (Gr.). When you want to add settings to the selected condition only, select the single mode (Sngl).
- A needle curve can be set.
- A switch can be set.
When [ON] is set, the function is operated by merely selecting the condition.
When setting and [ON]/[OFF] switch, touch the [ON] button and set the switch and its ON direction at the <Switch> screen.

< Acceleration function setting >

- Acceleration can be set at both setting at acceleration (High) and setting at deceleration (Low).
- The acceleration rate (Rate) and the return time after operation (Dump.) can be set.
- An operation point (Operation Point) at acceleration and deceleration can be set. When an operation point is exceeded, acceleration operation is performed.



PIT to RUD Mixing (Revolution Mixing)

Use this mixing when you want to suppress the reaction torque generated by main rotor pitch and speed changes at pitch operation. Adjust so that the nose does not move in the rudder direction.

An acceleration function which temporarily increases the correction rate at throttle stick acceleration/deceleration operation can be set. The mixing rate at acceleration/deceleration can be set.

However, when a GY Series or other heading hold gyro is used, since correction is performed by the gyro, this

mixing is not used. **If this function is used when the gyro operation mode is the AVCS mode, the neutral position will change.**

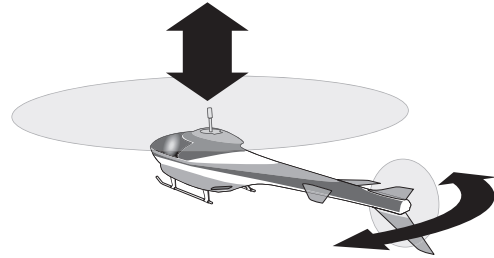

- Touch the [PIT to RUD] button in the Model Menu to call the setup screen shown below.

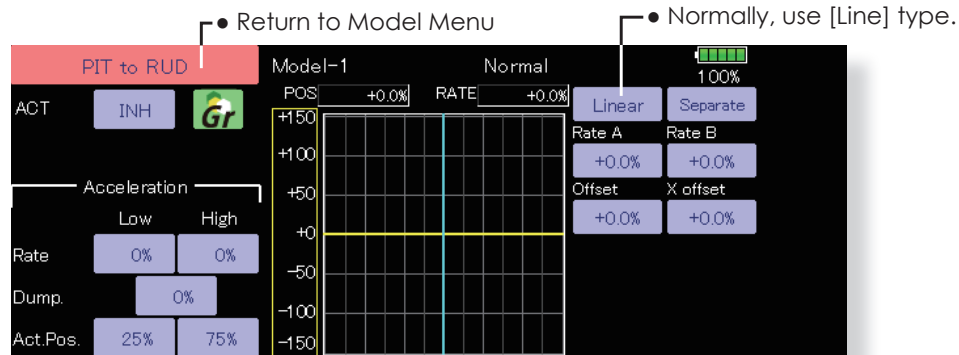

Setting method

- When using this function, touch the [INH] button and display [ON] or [OFF].
- When you want to set the same settings to other conditions, select the group mode (Gr.). When you want to add settings to the selected condition only, select the single mode (Sngl)
- A mixing curve is set.

<Normal condition mixing curve>

The mixing curve rate starts from a small value. For a rotor with a clockwise operation direction (polarity), when pitch was operated at the plus side, set so that mixing is in the clockwise direction. First, trim at hovering and then adjust the neutral position.

1. Adjustment between slow and hovering
Repeatedly hover from take off and land from hovering at a constant rate matched to your own rhythm, and adjust the pitch so the nose does not deflect when the throttle is raised and lowered.
2. Throttle high side (up to climbing from hovering and diving hovering)
*Repeat climbing and diving from hovering at a constant rate matched to your own rhythm and adjust the pitch so that the nose does not deflect when the throttle is raised and lowered.

<Idle up condition mixing curve>

Set the mixing rate so that the rudder direction at high-speed flight is straight ahead. Adjust for each condition used.

<Acceleration function setting>

- An acceleration function can be set. This is used when the mixture is either too rich or too lean, which can be caused by sudden operation of the throttle stick.
- Acceleration rate setting (Rate)
- The return time after operation (Dump) can be set for both settings (Acceleration [High] and Deceleration [Low]).
- An Operation Point during acceleration and deceleration can be set independently. When this point is exceeded, acceleration operation is performed.



Gyro Mixing

This function is used when a gyro is used to stabilize the fuselage attitude. The sensitivity and operation mode (Normal mode/GY mode) can be set up with three gyros for each condition respectively.

Sensitivity and operational mode (Normal mode/GY mode) can be set up for three Gyros for each condition, respectively.

Note: Always set both (ACT) and (Trim) for the [Gyro] function.

Setting example

- Normally, it is convenient to preset high sensitivity (Rate1) and low sensitivity (Rate2) when either the AVCS mode or Normal mode is used.
- A setup of the mode of three Gyros and Rete can be performed on this screen.

- Touch the [Gyro] button in the Model Menu to call the setup screen shown below.

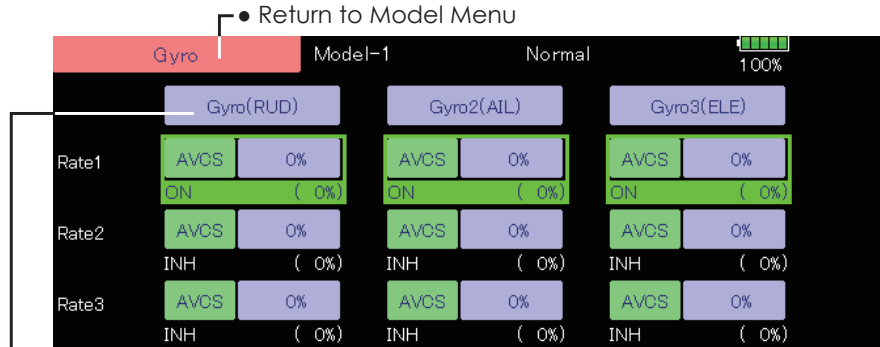

• Return to Model Menu

- A detailed setup of each Gyro can be performed on this screen.

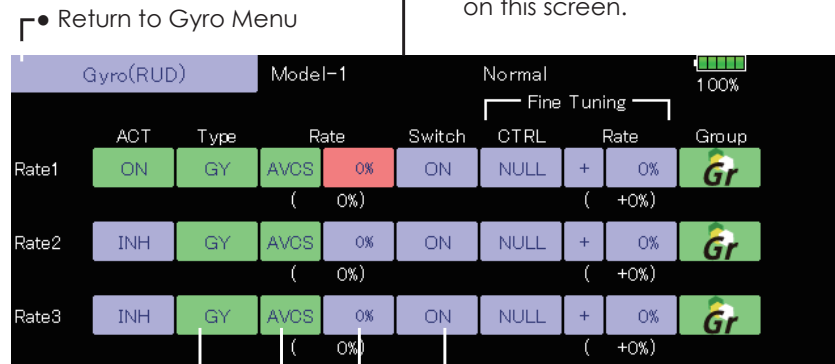

• Return to Gyro Menu

- Selects the selector switch.
- Adjusts the gyro sensitivity by rate.
- Selects [AVCS] or [NOR] (normal).
- Select the type of gyro used.

Setting method

- Touch the [INH] button of the rate to be used and display [ON].
- When you want to set the same settings to other conditions, select the group mode (Gr.). When you want to add settings to the selected condition only, select the single mode (Sngl).
- Three rates can be switched for each condition. (Rate1/Rate2/Rate3)
- A fine tuning VR can be set.



Governor Mixing

This is used to switch the RPM of the helicopters head. Up to three rates can be set for each condition.

*The governor is used by connecting the governor speed setting channel to governor function.

*When using an independent governor [ON]/[OFF] switch, connect the AUX ([ON]/[OFF]) connector of the governor to Governor2 and set the switch to Governor2 at the Function menu of the Linkage Menu.

- Touch the [Governor] button of the Model Menu to call the setup screen shown below.

*When using the Fuel Mixture function, the mixture servo is controlled from the governor. When transmitting the mixture curve data from the transmitter to the governor, the governor AUX (m.trm) connector must be connected to Governor2 function and governor side setting performed. See the governor instruction manual.

Note: Always set (Act) and (Trim) to [NULL] for [Governor] and [Governor 2] of the Function menu. The subtrim of [Governor] is made 0%. Make the reverse direction normal.

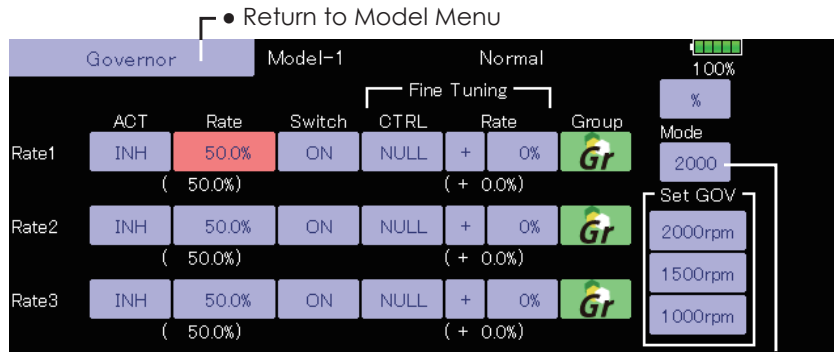

- When the "Mode" button on the Governor screen is pressed, the display mode is switched.
2000: 2000 rpm mode
2500: 2500 rpm mode

- The 2500 rpm mode and 2000 rpm mode are different when the rate is 50.0% (=2500 rpm) or greater. At rates below 50.0%, the rpm displays the same for both modes.
- When the 2500 rpm mode is set, 100.0%=2500 rpm
The maximum value is 110.0%=2700 rpm
- When the 2000 rpm mode is set, 100.0%=200 rpm
The maximum value is 110.0%=2100 rpm (Conventional specifications)
- There is no change in the transmitter output even when the 2500 rpm mode and 2000 rpm mode are switched. Calibration must be performed at the governor side.

Setting method

- Touch the [INH] button of the rate to be used and display [ON].
- When you want to set the same settings to other conditions, select the group mode (Gr.). When you want to add settings to the selected condition only, select the single mode (Sngl).
- Three speeds (rates) can be set for each condition. (Rate1/Rate2/Rate3)
- End point initialization
The governor output channel end point (ATV) "travel" and "limit" are now initialized when the governor setting "Operate" button was pressed.
- When switched from INH to ON or OFF, "travel" is initialized to 100 and "limit" is initialized to 155.
- When "Operate" of rates 1, 2 and 3 is switched to INH under all conditions, "travel" is initialized to 100 and "limit" is initialized to 135.

Also, this mixing and the governor side speed setting must be matched beforehand by the following method:

- Set so that when the governor side is placed in the speed setting item state and [2000 rpm] of Set GOV of the screen above is touched, the governor speed is set to "2000", when the [1500 rpm] button is touched, the governor speed is set to "1500", and when the [1000 rpm] button is touched, the governor speed is set to "1000".
- When you want to read the speed directly, press the [%] button and display [rpm].
- The speed can be switched by setting a switch. Also, when [OFF] is set instead of speed setting, the governor can be turned [ON]/[OFF] without setting a separate [ON]/[OFF] switch.
- A speed fine tuning VR can be set.
*VR selection, adjustment width, and adjustment direction can be set.



Throttle Limiter

This function limits the high range of the throttle movement by any slider or trimmer. The adjustment range of the high and low end can be set.

- Touch the [Throttle Limiter] button of the Model Menu to call the setup screen shown below.

• Return to Model Menu

Control selection button

Range gauge

Rate adjust button

Setting method

- Activate the mixing and select the on/off switch.
- Select the control for adjustment of the high limit.
- Set the high range. The range gauge shows the setting position.
- Set the low range same as high range setting.

The limit value at the operation hardware neutral position can now be adjusted using the throttle limiter.

1. Set "Center position" on the throttle limiter screen to Operate.
2. When the "Center position" rate is changed, the limit value at the operation hardware neutral position can be adjusted.
 - The limit value at the operation hardware neutral position when "Center position" was changed to INH (at conventional operation) is the center value between "High side range" and "Low side range".
 - When "Center position" was switched from INH to Operate, the "Center position" rate is reset to the center value between "High side range" and "Low side range"
 - The "Center position" rate can be set between "High side range" and "Low side range".

COMMON OPERATIONS USED IN FUNCTION SETUP SCREEN

This section describes the functions often used at the function setup screen. Refer to it when setting each function.

Operations related to flight conditions

Group/single mode switching (Gr./Sngl)

When setting multiple flight conditions, linking the setting contents with other conditions (Gr.) or setting independently (Sngl) can be selected. When the button is touched, it toggles between Gr. and Sngl.



*Group mode (Gr.) (initial setting): The same setting contents are set to all the flight conditions in the group mode.



*Single mode (Sngl): Select this mode when the setting contents are not linked with other conditions.

*Selecting the single (Sngl) mode at each condition after presetting in the group mode (Gr.) is convenient.

Condition delay setting

Unnecessary fuselage motion generated when there are sudden changes in the servo position and variations in the operating time between channels at condition switching can be suppressed.

When the delay function is set at the switching destination condition, a delay corresponding to that amount is applied and the related functions change smoothly.

[Setting method]

1. Switch to the condition you want to set.
2. Touch the Delay button.
3. Use the adjustment buttons to set the delay.

*Initial value: 0

*Adjustment range: 0~27 (maximum delay)

Operations related to VR tuning

Fine tuning VR setting

- VR selection
- Rate adjustment

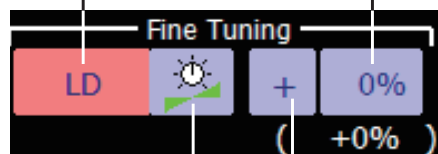

- Operation mode selection
 - Adjustment direction setting
- *Displayed at VR setting.

[Operation modes]

- Mixing rate 0% at center of VR
When the VR is turned counterclockwise and clockwise, the mixing rate increases and decreases, respectively.
- Mixing rate 0% at left end of VR
When the VR is turned, the mixing rate increases.
- Mixing rate 0% at right end of VR.
When the VR is turned, the mixing rate increases.
- When the VR is turned to the left or right of the neutral position, the mixing rate increases.

Operations related to servo speed

Servo speed setting (1)

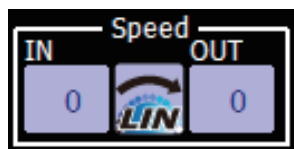

The speed during operation (including flight condition switching) can be adjusted. The servos operate smoothly at a constant speed corresponding to the speed set for them. The operation speed (In Speed) and the return speed (Out Speed) can be set individually.

Switch the operation mode according to the set function. When the button is touched, it toggles between [LIN] and [SYM].

"SYM" mode: Mode used with ailerons and other self-neutral functions

"LIN" mode: Mode used with functions which hold the operation position of the throttle and switch channel, etc.

[Setting method]

1. Select the function ([LIN] or [SYM]) matched to the master channel. Each time the button is touched, it toggles between [LIN] and [SYM].
2. Touch the In or Out Speed button and set the servo speed.

Initial value: 0

Setting range: 0~27



Servo speed setting (2) (Prog. Mix only)

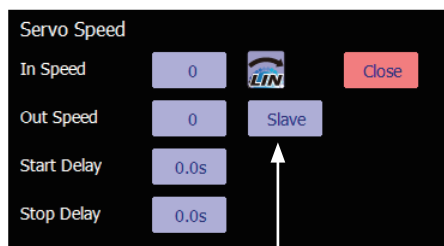

Speed mode: Slave/Master

The speed mode can be selected.

Slave mode: The speed at programmable mixing switching can be adjusted. The servos operate smoothly at a constant speed corresponding to the set speed.

Master mode: The servo movement is traced by the setting curve. The trace speed is adjusted by in and out speed.

[Setting method]

1. When setting the servo speed, touch the Speed button. The Servo Speed setup screen shown above is displayed.

2. Select the function ([LIN] or [SYM]) matched to the master channel. Each time the button is touched, it toggles between [LIN] and [SYM].

"SYM" mode: Mode used with ailerons and other self-neutral functions.

"LIN" mode: Mode used with functions which hold the operating position of the throttle and switch channel, etc.

3. Touch the In Speed button and set the servo speed.

Initial value: 0

Setting range: 0~27

4. Touch the Out Speed button and set the servo speed.

Initial setting: 0

Setting range: 0~27

5. Touch the Start Delay button and set the delay time from switch ON to the start of function operation.

Initial setting: 0.0 sec

Setting range: 0~4 secs

6. Touch the Stop Delay button and set the delay time from switch OFF to the start of function operation.

Initial setting: 0

Setting range: 0~4 secs

At master mode;

1. Set desired in and out speed.
2. Select the master channel to any toggle switch.
3. The slave channel's servo traces the setting curve as the master toggle switch is moved. Below the case, AUX1 servo traces an EXP1 curve as the SW-F is operated.

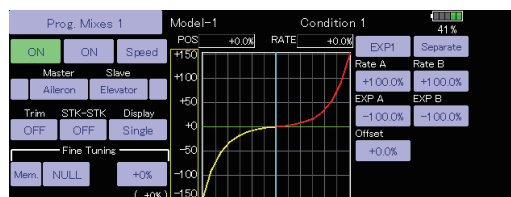

Curve setting operation

This section describes the setting procedure of curves which are used with the AFR function and each mixing function.

Curve type selection

When the curve type select button on the mixing function screen or other screen is touched, the setup screen shown below is selected.

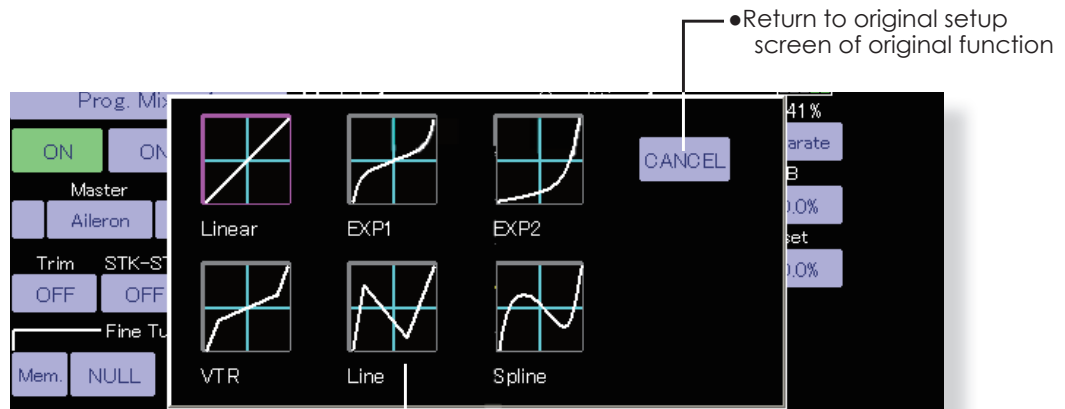

Curve type selection

1. Touch the button of the curve type you want to use.
*The curve type changes and the display returns to the original screen.

When curve type is changed:

The curve shape is inherited when the curve type is changed.

(Example: Changes from EXP1 to Line curve type.)

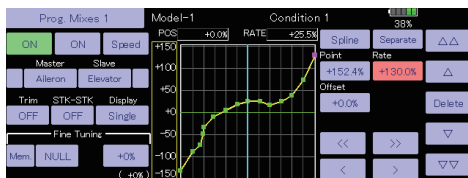

Changed to line or spline mode, the curve is retrieved as 17 points curve.

The RateA and RateB are inherited on the linear, EXP1, EXP2 and VTR.

Other data except RateA and RateB are retrieved from

the previous setting data when changing the curve type.

At the curve type changes, the dialogue box asks whether the current curve is reset or inherited. The default curve is used when selecting the Yes button on the confirmation dialogue.

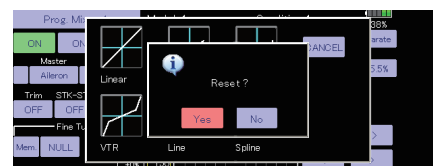

Setting by curve type

When the curve type is selected as described above, adjustment buttons corresponding to the curve type appear on the original screen. Adjust each curve as described below.

Linear curve adjustment

RateA and RateB can be adjusted separately or simultaneously.

[Setting modes]

***[Separate] mode:** Rates are adjusted separately.

***[Combined] mode:** Rates are adjusted simultaneously.

[Setting method]

1. Select the setting mode.
2. Touch the RateA or RateB button.
3. Use the adjustment buttons to set the rate.

*Initial value: +100.0%

*Adjustment range: -200.0~+200.0%

The curve can also be offset horizontally in the vertical direction and the rate reference point can be offset to the left or right.

[Offsetting the curve horizontally in the vertical direction]

1. Touch the Offset button.
2. Use the adjustment buttons to move the curve horizontally up and down.

*Initial value: +0.0%

[Offsetting the rate reference point to the left or right]

1. Touch the X Offset button.
2. Use the adjustment buttons to move the reference point to the left or right.

*Initial value: +0.0%

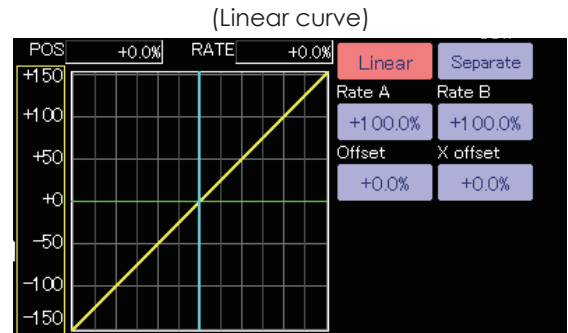

(Rate adjustment buttons)

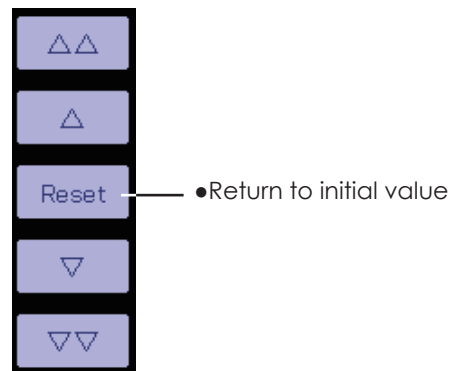

EXP1 curve adjustment

RateA and RateB can be adjusted separately or simultaneously. The EXP curves rate (EXP A, EXP B) can also be adjusted separately or simultaneously.

[Setting modes]

***[Separate] mode:** Rates are adjusted separately.

***[Combined] mode:** Rates are adjusted simultaneously.

[Setting method]

1. Select the setting mode.
2. Touch the button of the rate or EXP curve rate you want to set.
3. Use the adjustment buttons to set the rate.

*Initial value: +100.0% (rate), +0.0 (EXP rate)

The curve can also be horizontally offset in the vertical direction.

[Offsetting the curve horizontally in the vertical direction]

1. Touch the Offset button.
2. Use the adjustment buttons to move the curve horizontally up or down.

*Initial value: +0.0

VTR curve adjustment

RateA and RateB can be adjusted separately or simultaneously. The VTR curve point positions (P.Pos.A, P.Pos.B) and rates (P.RateA, P.RateB) can also be adjusted separately or simultaneously.

[Setting modes]

***[Separate] mode:** Positions and rates are adjusted separately.

***[Combined] mode:** Positions and rates are adjusted simultaneously.

[Setting method]

1. Select the setting mode.
2. Touch the button of the rate or VTR curve point position (or rate) you want to set.
3. Use the adjustment buttons to set the VTR curve point position (or rate).

*Initial values: +100.0% (Rate), +50.0% (P.Pos.A), +50.0% (P.Pos.B), +0.0% (P.Rate)

The curve can also be offset horizontally in the vertical direction.

[Offsetting the curve horizontally in the vertical direction]

1. Touch the Offset button.
2. Use the adjustment buttons to move the curve horizontally up and down with the adjustment buttons.

*Initial value: +0.0%

(EXP1 curve)



- Using the EXP1 curve is helpful in smoothening starting of the ailerons, elevators, rudder, etc.

(EXP2 curve)

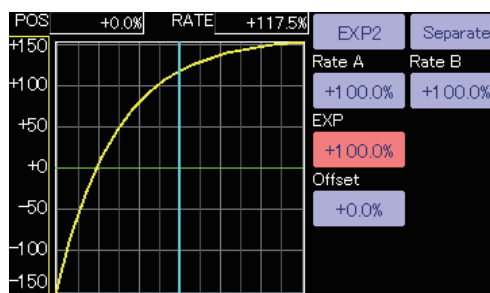

- Using the EXP2 curve is helpful in engine rise and other engine control.

(VTR curve)

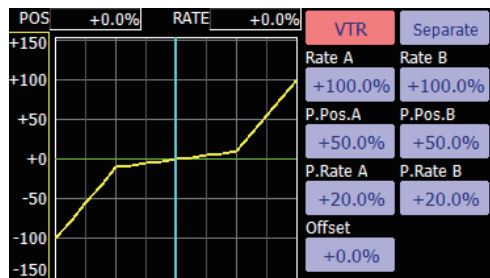

- Setting is fast if left, right, up, and down are first decided in the Combined mode and the mode is then switched to the Separate mode.

When this curve is used when the operating rudder angle is large such as with acrobatic models, switching from normal flight to acrobatic rudder angle is performed without switch operation.

Line and spline curve adjustment

Line curves or spline curves of up to 17 points can be used. (Initial value: 7/9 points) The set points can be freely increased, decreased, and offset. Curves which are symmetrical to the left and right of center can also be set.

[Setting modes]

***[Separate] mode:** Normal setting

***[Combined] mode:** Creates a left and right symmetrical curve.

[Adjusting the rate of each point]

1. Use the move between points buttons [<<] or [>>] to select the point. (The pink point is the selected point.)
2. Touch the Rate button.
3. Use the adjustment buttons to adjust the rate.

[Point addition method]

1. After touching the point button, move the stick, etc. to the point you want to add and press the [Move] button. (An outlined point appears on the graph.)

Or move the stick, etc. to the position you want to add and press the [Move] button. (An outlined point appears on the graph.)

2. Use the move buttons [<] or [>] to fine adjust the position.

3. Touch the Insert button.

*A new point is created.

[Point deletion]

1. Use the move between points button [<<] or [>>] and select the point. (The pink point is the selected point.)
2. Because [Rate] is pushed and [Delete] is displayed, touch the [Delete] button. (The selected point becomes an outlined point.)
3. Touch the move between point button [<<] or [>>].

*The point is deleted.

The curve can also be offset horizontally in the vertical direction.

[Offsetting the curve horizontally in the vertical direction]

1. Touch the Offset button.
2. Use the adjustment buttons to move the curve horizontally up and down.

*Initial value: +0.0%

(Line curve)



(Spline curve)



(Rate adjustment buttons)

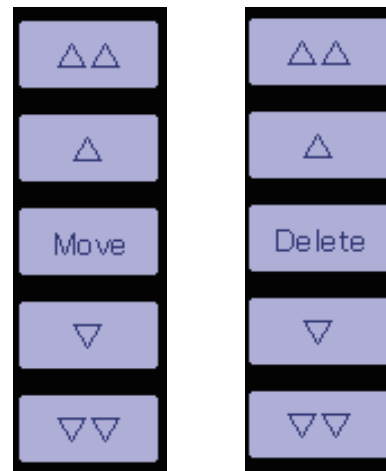

Switch selection method

The various functions used in the T32MZ can be selected by switch. The switch (including when stick, trim lever, or VR are used as a switch) setting method is common to all functions.

Switch mode selection (Single switch/Logic switch)

When the switch select button in a mixing function screen or other screen is touched, the switch mode selection screen shown below is selected. Single mode or logic mode can be selected.

Logic switch

The Logic switch can activate functions by the use of other switch combinations. Up to 4 switch combinations can be set. The Logic switch can be assigned to the mixing function as well as the flight condition select (except for Snap roll function on airplane mode).

(Switch mode selection screen example)

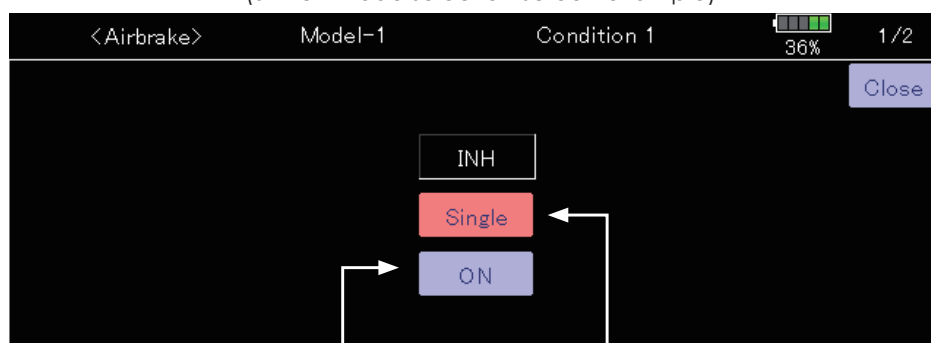

*In case of the flight condition select, the top of the switch on/off status display is not shown.

●Switch selection button

●Mode selection button

If using the single switch:

1. Push the switch selection button.
*The switch selection screen appears.

If using the logic switch:

1. The switch mode display is changed by pushing the mode selection button. Then push the [Yes] button.
*The logic mode setting screen appears.
*For a description of the logic mode setting method, see the section "Logic switch" below.

Logic switch

In the Logic screen, the switch selection buttons appear on both the left and right side of the display.

(Logic switch setting screen)

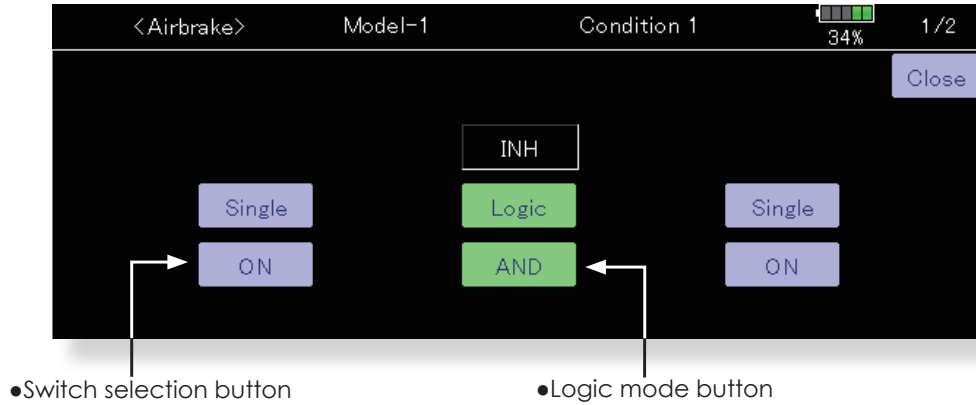

1. The logic selection dialogue appears when you push the logic mode button. The 3 types of logic, either AND, OR or EX-OR, can be selected.

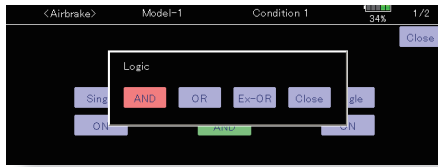

Logic combination table:

SWITCH		LOGIC		
SW1	SW2	AND	OR	Ex-OR
off	off	off	off	off
off	on	off	on	on
on	off	off	on	on
on	on	on	on	off

2. The left and right side of the switch mode can be set to the logic switch mode as well. In this case, a maximum of 4 switches can be assigned to the logic switch. The left and right logic are calculated first, then the center of the logic is calculated. Finally, switch on/off status determined by the 4 switches' combination.

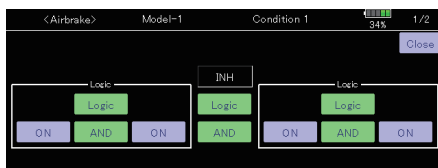

In the above case, the two switches in the left are calculated by AND logic. Next the two

switches in the right are calculated as same way. Finally the first case and 2nd case are calculated by OR logic.

Caution:

1. The maximum number of the logic switch is 10 for the flight condition select and 8 for the mixing on/off selection on each flight condition. The error message will appear when the exceeded logic switch is going to be selected. In this case, delete the unused logic switch first, then select the new logic switch.

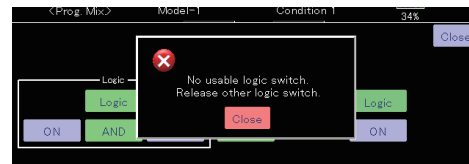

2. The mixing on/off switch modes are automatically assigned by single mode, not supported the group mode.

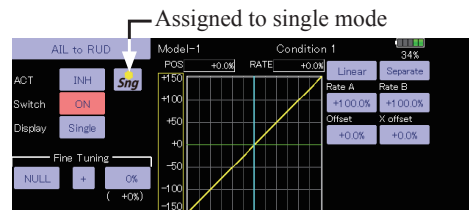

Switch selection

When the switch selection button in switch mode selection screen or the logic switch setting screen is touched, the screen below is shown.

(Switch selection screen example)

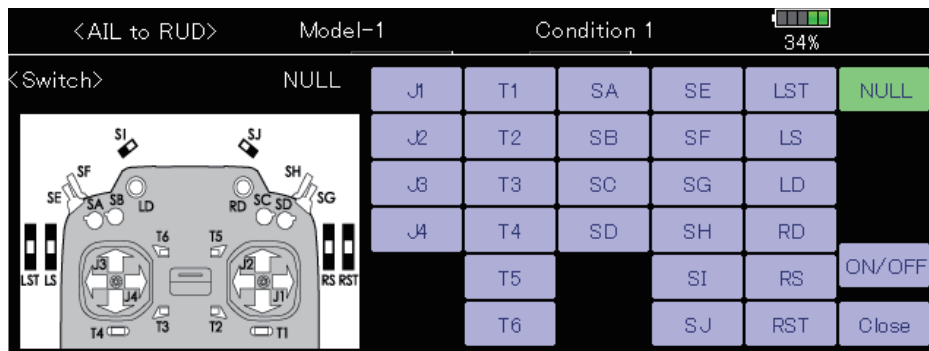

When switch is selected

Switch ON/OFF setting is possible at each position.

- **Alternate:** Alternate switching mode is available depending on mixing function.

1. When the ON position switch is touched after the switch was selected, the screen shown below appears.

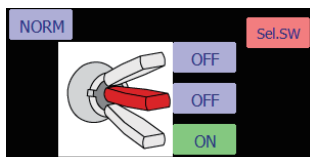

*When the button of each position is touched, it toggles between ON and OFF.

2. Touch the button and set to the ON position.
3. Close the screen by touching [Close].

When stick, trim lever, or VR is selected.

When a stick, trim lever, or VR is used as a switch, the following 4 modes can be selected.

- **Mode:** Lin/Sym
- **Type:** Hysteresis (Hys.)/box (Box)

1. When the ON position button is touched after stick, etc. was selected, the screen shown below appears.

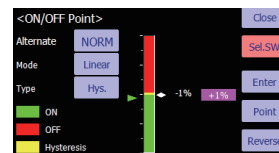

2. Select the mode you want to use, and set it as described below.
3. Close the screen by touching [Close].

Operation modes

The operation modes when stick, trim lever or VR are selected are described below. Change the operation mode by touching the Mode and Type buttons.

Linear hysteresis mode

This setting method selects function ON/OFF based on the set point. Hysteresis (dead band) can be set between ON and OFF. The ON and OFF positions can be reversed with the Reverse button.

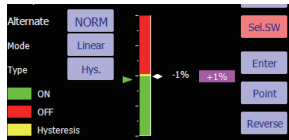

Symmetrical hysteresis mode

Operation is the same as the linear hysteresis mode, but left and right (up and down) operations are symmetrical about the neutral position. For example, when you want to switch DR1 with the aileron stick, when the stick is moved to the left or right, DR1 can be turned ON at the same left and right position.

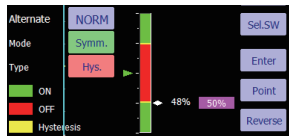

Linear box mode

This mode turns on the switch within a range of 2 points. Each point can be set. The ON and OFF positions can be reversed with the Reverse switch.

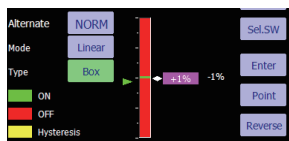

Symmetrical box mode

Operation is the same as the linear box mode, but left and right (up and down) operation is symmetrical about the neutral position.

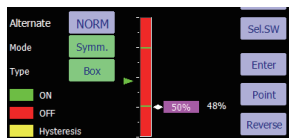

When shifting the ON/OFF point

The ON/OFF and hysteresis (dead band) boundary point (there are 2 points: top and bottom) position can be shifted. ON/OFF is possible at a free position.

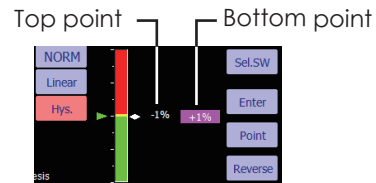

[Setting method]

1. Select the top and bottom boundary points with the [Point] button.
2. Move the stick, etc. to the point you want to shift and touch the [Enter] button. The boundary points change.

*Also shift other points, as required.

UPDATING

Your Futaba T32MZ transmitter programming can be updated easily and at no cost online. When functions are added or improved, the update file can be downloaded from our website. Copy the update files to the microSD card and then use the following procedure to update the program.

Check our web site for the FAQ regarding updating for more information.

Updating procedure

Note: If the battery fully discharges during program updating, updating will fail. When the remaining battery capacity is 50% or less, always recharge the battery before updating.

Note: The model data in the transmitter can be used unchanged after updating, but to be safe, back up the model data before updating.

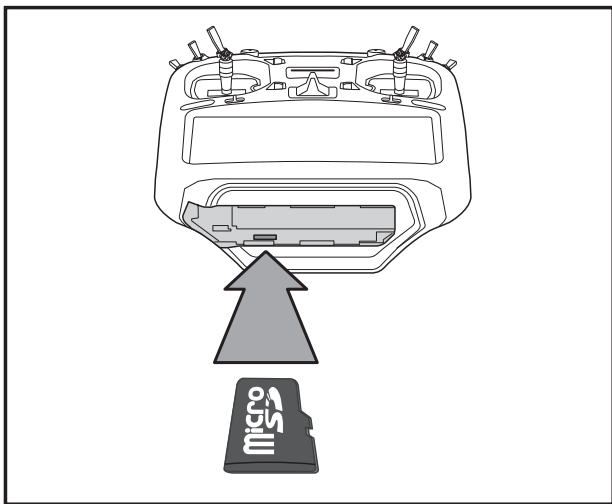

1. Insert the microSD card containing the update file into the card slot.

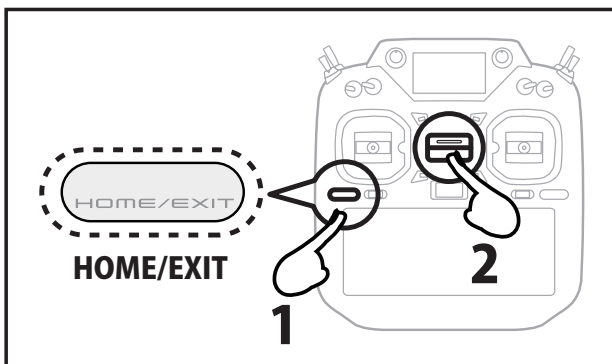

2. Press the HOME/EXIT button first. AND next turn on the transmitter power. An update screen is displayed.

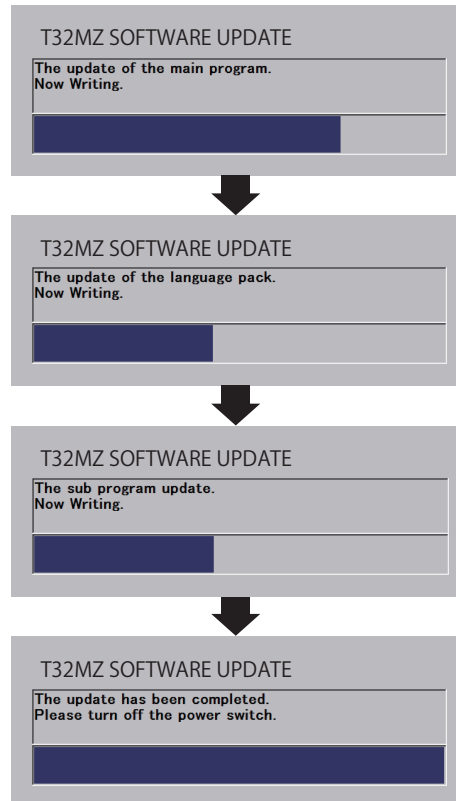

If a problem occurs, an error message will appear and the update will not be complete.

After the updating above has been completed, turn on the power and then check the system program version at the system menu information screen.

T18MZ (WC) → T32MZ MODEL DATA CONVERSION

The model data (only latest version) of T18MZ (WC) can be copied to T32MZ.

- * A microSD card and an SD card adapter are required.
- * The model data of T32MZ cannot be copied to T18MZ (WC).

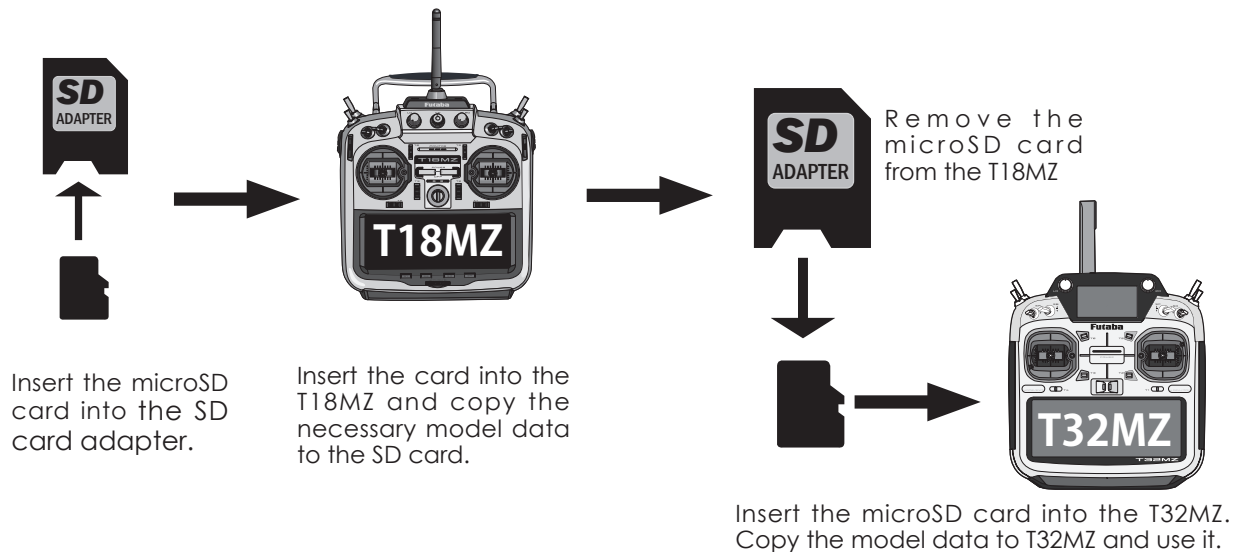

*When microSD card cannot be recognized, it may be able to be used if it reformat by SD formatter offered from SD Association.

SD formatter is downloadable from SD Association (<https://www.sdcard.org/>).

(As of April, 2019)

⚠ CAUTION

- ❗ After the completion of a data copy should fully perform a check of operation on the model to be used.
- ❗ Check well all the directions of operation and all the operation switches.

FUTABA CORPORATION

oak kandakajicho 8F 3-4 Kandakajicho, Chiyoda-ku, Tokyo 101-0045, Japan
TEL: +81-3-4316-4820, FAX: +81-3-4316-4823

©FUTABA CORPORATION 2019, 6 (1)

